

F6

MultiTrack Field Recorder

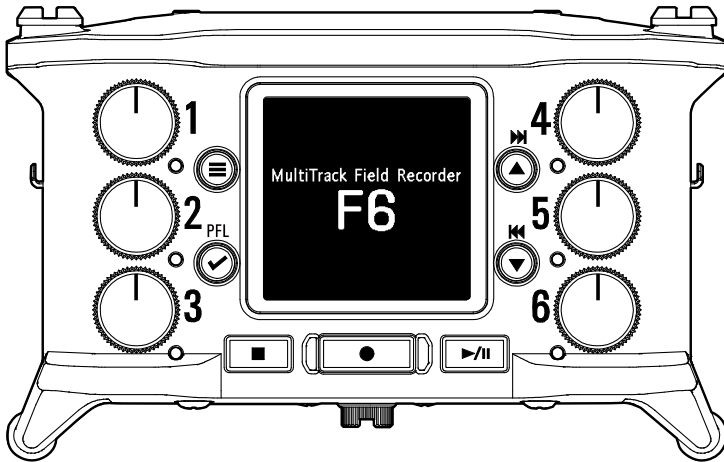

Quick Guide

You must read the Usage and Safety Precautions before use.



The Operation Manual can be downloaded from the ZOOM website (<https://www.zoom.jp/docs/f6>). This page has files in PDF and ePub formats.

The PDF file format is suitable for printing on paper and reading on a computer. The ePub format can be read with electronic document readers and is designed for reading on smartphones and tablets.

© 2019 ZOOM CORPORATION

Copying or reprinting this manual in part or in whole without permission is prohibited.

Product names, registered trademarks and company names in this document are the property of their respective companies.

You might need this manual in the future. Always keep it in a place where you can access it easily.

The contents of this manual and the specifications of the product could be changed without notice.

Windows® is a trademark or registered trademark of Microsoft® Corporation.

Mac is a trademark or registered trademark of Apple Inc.

Connections

Left side

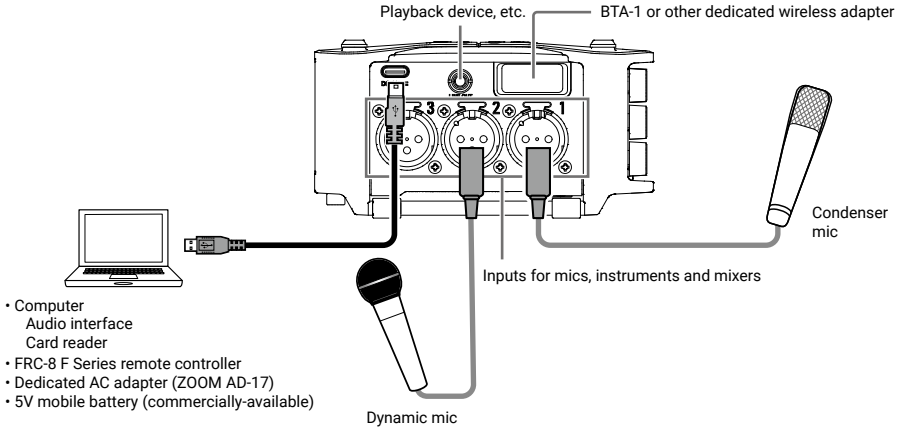

Right side

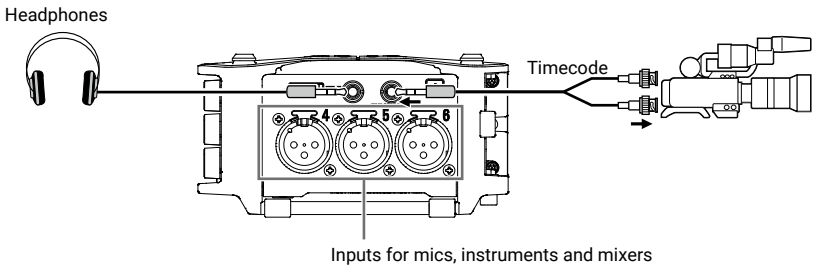

NOTE

The timecode cable input and output should have the following specifications.

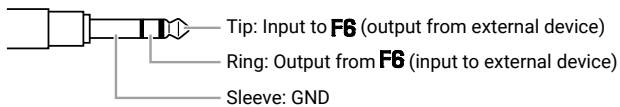

The XLR 1-6 inputs have the following specifications.

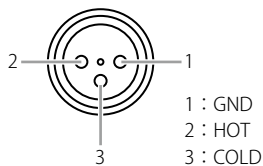

Preparations

Supplying power

Power can be supplied using AA batteries, an L battery or USB.

■ AA batteries

1. Loosen the screw in the battery cover on the bottom.
2. Open the battery cover on the bottom, and remove the battery case.
3. Install 4 AA batteries in the battery case.
4. Put the case into the compartment.
5. Close the battery cover and tighten the screw.

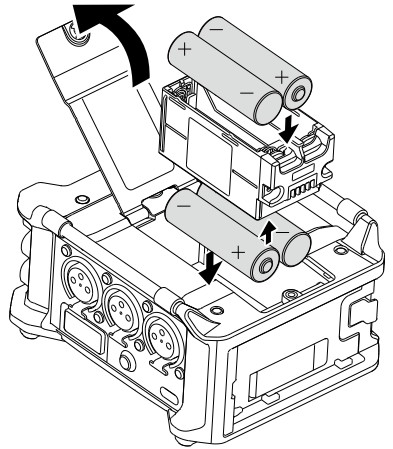

■ L battery

1. Slide the battery in the direction of the arrow while pressing it toward the recorder.

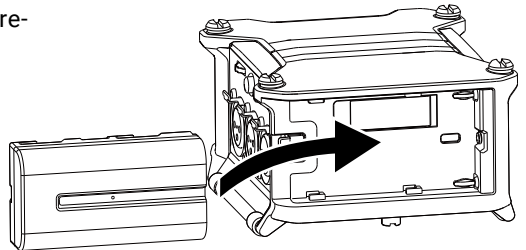

NOTE

After loading batteries, use Menu > SYSTEM > Settings > Power Source > Type to set the correct type of battery.

HINT

A USB type C cable can also be connected to the USB port to operate it using AC power.

Installing the camera mount adapter

1. Remove the 4 screws from the top of the **F6**.

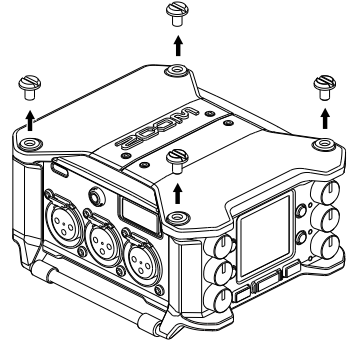

2. Align the screw positions of the camera mount adapter with those of the **F6**, and tighten the screws.

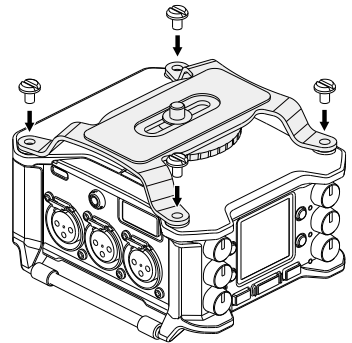

3. Attach the **F6** to a tripod, for example, and then attach the camera with the camera mount adapter screw.

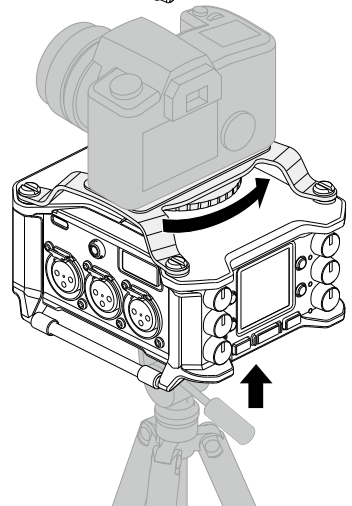

Loading SD cards

1. Open the SD card slot cover, and insert an SD card.

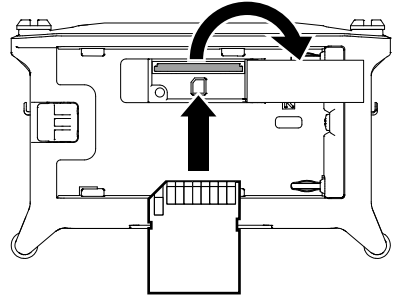

HINT

To remove the SD card, push it further into the slot and then pull it out.

NOTE

Before using SD cards that have just been purchased or that have been formatted on a computer, they must be formatted by the **F6**. To format an SD card, use Menu > SYSTEM > SD Card > Format.

Turning the power on and off

1. Press and hold  to turn the power on.

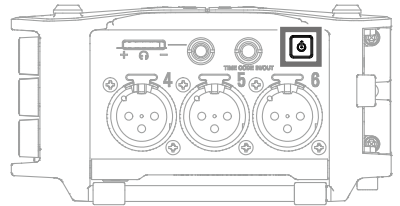

HINT



Press and hold  to turn the power off.

NOTE

- If "No Card!" appears on the display, confirm that an SD card is inserted properly.
- If "Card Protected!" appears on the display, the SD card write-protection is enabled. Slide the lock switch on the SD card to disable write-protection.
- If "Invalid Card!" appears on the display, the card is not formatted correctly. Format the card or use a different card.

Setting the language (first time starting up)

The first time you turn the power on after purchase, set the display language when the Language setting screen opens.

1. Use  and  to select the display language, and press .











HINT

The language setting can be changed later using Menu > SYSTEM > Language.

Setting the date and time (first time starting up)

When the Date and Time setting screen opens after the Language settings screen, set the date and time.

1. Use  and  to select the item to change, and press .
2. Use  and  to change the value, and press .
3. Use  and  to select "Enter", and press .

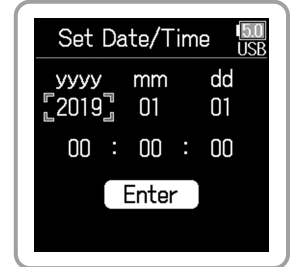

HINT

The date and time setting can be changed later using Menu > SYSTEM > Settings > Date/Time > Set Date/Time.

Display overview

■ Home Screen

Status icons

- Stopped
- Paused
- Recording
- Playing back

Counter
During recording: Elapsed/remaining recording time
During playback: Elapsed/remaining playback time

Recording/playback sample rate
48.00

Clipping indicator

Level meter

Track number
Red: Input enabled
Green: Playback track enabled
Gray: Input disabled

Adjacent track numbers are connected to show input link settings.

- 1 2 3 4 Mono
- 1 2 3 4 Stereo
- 1 2 3 4 Ambisonic

Power type and remaining amount
USB: Power supply connected to port
EXT: L battery
AA: AA batteries

Recording/playback take name
When stopped, press and hold to show the name that will be given to the next recorded take.

Recording/playback timecode
INT 29.9D 00:40:41:20

Frame rate
INT: Internal timecode enabled
EXT: External input timecode enabled

HINT

The **F6** has two Record setting modes, Linear (16/24-bit) and Float (32-bit), with the following characteristics.

Linear: This mode records ordinary 16/24-bit WAV files. Adjust input (trim) levels so that the clip indicators do not light when recording. The level meters show input levels after adjustments.

Float: This mode records 32-bit float WAV files. Adjusting input levels is unnecessary. As long as maximum input levels are not exceeded, both quiet and loud sounds can be recorded with high quality. The level meters show levels after adjustments by [Track] knobs.



NOTE

Some of the screen will appear differently when the recording mode is Float (32 bit).

Input and output settings

Setting the input source

Set the input source using Menu > INPUT > PFL > Input 1–6
> Source.

-  Open the Menu Screen.
-  Select up/down.
-  Confirm.





Setting	Explanation
Mic	Select this when connecting a mic or other equipment with a low input level.
Mic (PH)	Use this setting for mic level with phantom power.
Line	Select this when connecting line level equipment. The input level will be reduced 20 dB compared to when "Mic" is selected.
Line (PH)	Use this setting for line level with phantom power.
USB 1–4	When the "AIF with Rec" setting is on, computer output signals are treated as input signals.

HINT

- Menu > INPUT > Phantom Settings can be used to set the phantom power voltage and change the power conservation setting (power supply during playback).
- To return to the Home Screen from the Menu Screen, press  to go back one menu level at a time.

Adjusting input levels (trim)

When the recording setting mode is not “Float (32 bit)”, use Menu > INPUT > PFL > Input 1–6 > Trim to adjust the input level.

-  Open the Menu Screen.
-  Select up/down, adjust value.
-  Confirm.

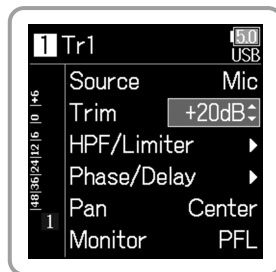

HINT

See “Adjusting headphone volume” (→ P. 10) for how to adjust the headphone volume.

Enabling tracks

You can select which among Inputs 1–6 to use.

Inputs will be recorded on tracks with the same numbers. For example, Input 1 will be recorded on track 1 and Input 2 will be recorded on track 2.

1. Turn the  with the same number as the input you want to record right, making the track status indicator light.

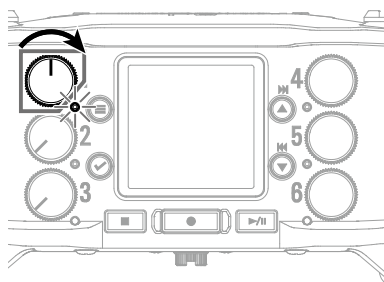

Status indicator	Track number screen background color	Explanation
Lit red	Red	The input is enabled.
Unlit	Gray	The input is disabled.

Adjusting track volume

1. Turn  for a track to adjust its volume.

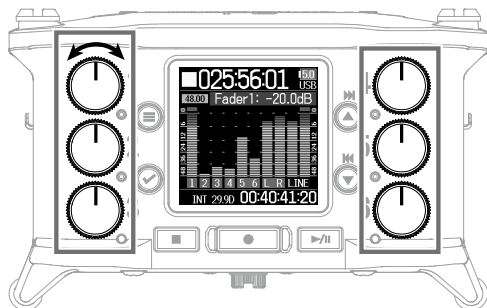

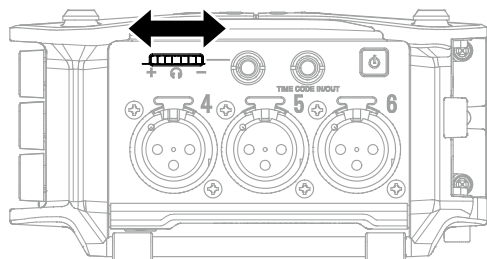

Adjusting headphone volume

1. Turn .



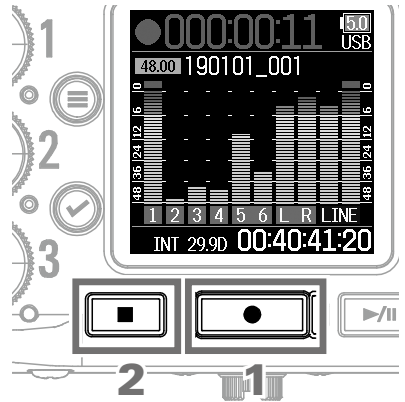

Recording

1. Press .
This starts recording.
2. Press .
This stops recording.





Operations during recording

Function	Operation
Pause & Mark/Resume	Press  .
Start recording the next take.	Press  . This will stop recording in the current take and start recording in a new take without interruption.

NOTE

If the file size exceeds 2GB during recording, a new take will be created automatically and recording will continue without interruption. No gap in sound will occur between the two takes when this happens.

HINT

- The clip indicators will appear lit when loud sounds are input. Adjust the input level so that the clip indicators do not light.
- Clip indicators that have appeared once can be cleared by pressing  while pressing .

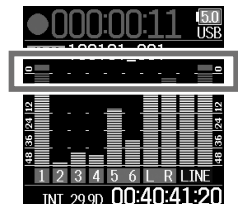



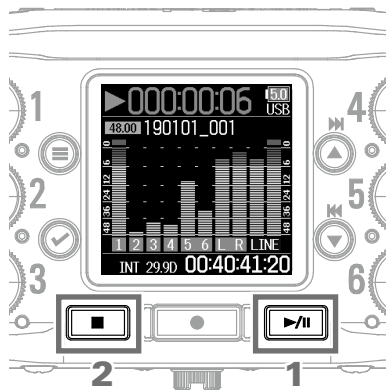

Playing recordings

1. Press .
This starts playback.
2. Press .
This stops playback.



■ Playback operations

Function	Operation
Pause/resume	Press  .
Select take/Jump to mark	Press  /  .
Search forward	Press and hold  .
Search backward	Press and hold  .

List of functions and settings

When the Home Screen is open, press  to open the Menu Screen where you can use the following functions and settings.

Item	Explanation		
FINDER	The Finder allows you to view and edit takes and folders on SD cards, create project/scene folders, and make recording/playback folder settings, for example.		
INPUT	PFL	Use to set the Input Source, Trim, HPF, Limiter, Phase, Delay and Pan and the monitoring sound when the PFL screen is open.	
	Phantom Settings	Use to set phantom power voltage and energy conservation function.	
	Link Settings	Use to set input and trim linking.	
	Auto Mix	When using multiple inputs, use to set this function that reduces background noise for tracks with low input levels by automatically attenuating their levels.	
OUTPUT	Headphone Out	Use to set the headphone output routing, digital boost, volume curve and alert sound level.	
	Line Out	Use to set the line output level, routing, limiter and delay.	
REC	Mode (The items shown in the Rec menu differ according to the set mode.)	Use to set the recording mode and bit depth of recorded WAV files.	
	When the mode is not MP3	Sample Rate	Use to set the sample rate used to record WAV files.
		File Format	Use to set the file format used to record files.
		Metadata	Use to set how scene names are added, and notes and track names are saved as metadata.
		LR Track	Use to set whether or not to record the L/R track and to set the L/R track volume.
	When the mode is MP3	Pre Rec	Use to set pre-recording, which captures audio before recording starts.
		Sample Rate	Use to set the sample rate used to record MP3 files.
		Bit Rate	Use to set the bit rate used to record MP3 files.
		Scene Name	Use to set how scenes are named.
		LR Fader	Use to set the volume of the L/R track.
Pre Rec		Use to set pre-recording, which captures audio before recording starts.	
PLAY	LR Fader	Use to set the volume of the L/R track.	
	Repeat	Use to set the playback repeat function.	
TIMECODE	Mode	Use to set the timecode mode, timecode output when recording is stopped, synchronization with audio clock, and internal timecode operation when there is no external timecode input.	
	FPS	Use to set the frame rate of the internal timecode.	
	Jam	Use to set jamming of the timecode input through the TIMECODE IN/OUT jack by the internal timecode. This can be used to restart the internal timecode at a chosen set value.	
	Ubits	Use to set the mode and content of user bits that can be included in timecode.	
	Auto Rec Delay	Use to set the amount of time until recording starts after timecode is received.	
	Start TC	Use to set the value used when jamming timecode starts and for calibration to increase the precision when jamming to RTC.	
SYSTEM	SD card	Use to back up and load settings, as well as to show information about, test performance of and format the SD card.	
	USB	Use to set card reader, audio interface, and simultaneous recording and audio interface use functions as well as to make settings when connected to an FRC-8.	
	Bluetooth	Use this for Bluetooth connection with iOS and timecode devices.	
	Settings	Use to set the date and time, power source, button operations, power saving function, and display, for example, as well as to restore all settings to their factory defaults.	
	Firmware Version	Use to check firmware versions.	
	Language	Use to set the language shown on the display.	

Note: See the Operation Manual for detailed information about each setting.

Specifications

Recording media	SD cards, SDHC cards, SDXC cards (that conform to standards)		
Inputs	Inputs 1–6	Connectors	XLR jack (pin 2 hot)
	Input (mic)	Input gain	+12 dB - +75 dB
		Input impedance	3 k Ω or more
		Maximum input level	+4 dBu
		Input (line)	Input gain
	Input (line)	Input impedance	5 k Ω or more
		Maximum input level	+24 dBu
	Phantom power	+24/+48V 10mA maximum for each channel	
	Equivalent input noise	-127 dBu or less (A-weighted, +75 dB input gain, 150 Ω input)	
	Outputs	Line output	Connectors
Output impedance			100 Ω or less
Reference output level			-10 dBV, 1 kHz, 10 k Ω load
Maximum output level			+10 dBV, 1 kHz, 10 k Ω load
D/A dynamic range			95 dB typ (-60dBFS input, A-weighted)
Headphone output		Connector	3.5 mm stereo mini unbalanced output
		Output impedance	15 Ω or less
		Maximum output level	100 mW + 100 mW (32 Ω load)
		D/A dynamic range	108 dB typ (-60dBFS input, A-weighted)
		Recording formats	When WAV selected
Recording formats	Supported formats	44.1/47.952/48/48.048/88.2/96/192 kHz, 16/24-bit/32-bit float, mono/stereo/2-8ch poly, BWF/iXML	
	Maximum simultaneous recording tracks	14 (6 inputs x 2 (Linear and Floating) + LR mix)	
	When MP3 selected		
	Supported formats	128/192/320 kbps, 44.1/48 kHz, ID3v1 tags	
	Maximum simultaneous recording tracks	2	
	Recording time	Using a 32 GB card	30:46:00 (48 kHz/24-bit stereo WAV)
Timecode		7:41:00 (192 kHz/24-bit stereo WAV)	
	Connectors	3.5 mm stereo mini (Tip: IN, Ring: OUT)	
	Modes	Off, Int Free Run, Int Record Run, Int RTC Run, Ext, Ext Auto Rec (audio clock can be synchronized to timecode)	
	Frame rates	23.976 ND, 24 ND, 25 ND, 29.97 ND, 29.97 D, 30 ND, 30 D	
	Precision	± 0.2 ppm	
	Allowed input level	0.2 – 5.0 Vpp	
	Allowed input impedance	4.6 k Ω	
	Output level	3.3 Vpp	
	Output impedance	50 Ω or less	
	Power	AC adapter	DC 5V (supports USB bus power)
Sony® L-Series battery		4 AA batteries (alkaline, lithium or rechargeable NiMH batteries)	

Continuous recording time	48 kHz/16-bit 2ch recording to SD card (LINE OUT off, TIMECODE off, LED/LCD Brightness 5, headphones into 32Ω load, PHANTOM off)			
	Alkaline batteries	7.5 hours or more		
	NiMH batteries (2450 mAh)	10.5 hours or more		
	Lithium batteries	16.5 hours or more		
	48 kHz/24-bit 6ch recording to SD card (LINE OUT off, TIMECODE off, LED/LCD Brightness 5, headphones into 32Ω load, PHANTOM off)			
	Alkaline batteries	5.0 hours or more		
	NiMH batteries (2450 mAh)	7.0 hours or more		
	Lithium batteries	10.5 hours or more		
	192 kHz/24-bit 6ch recording to SD card (LINE OUT on, TIME CODE set to Int Free Run, LED/LCD Brightness 60, headphones into 32Ω load, PHANTOM at 48 V)			
	Alkaline batteries	0.5 hours or more		
NiMH batteries (2450 mAh)	1.5 hours or more			
Lithium batteries	3.5 hours or more			
Display	1.54" full-color LCD (240 × 240)			
USB	Mass storage operation			
	Class	USB 2.0 High Speed		
	Multitrack audio interface operation (driver required for Windows, no driver required for MacOS)			
	Class	USB 2.0 High Speed		
	Specifications	Sampling rate	44.1/48/88.2/96 kHz	
		Bit Rate	16/24-bit	
		Channels	6 in/4 out	
	Stereo mix audio interface operation (no driver required)			
	Class	USB 2.0 Full Speed		
	Specifications	Sampling rate	44.1/48 kHz	
		Bit Rate	16-bit	
		Channels	2 in/2 out	
	Note: iOS device audio interface operation supported (stereo mode only)			
	AIF with Rec operation (driver required for Windows, no driver required for MacOS)			
	Class	USB 2.0 High Speed		
	Specifications	Sampling rate	44.1/48 kHz	
Bit Rate		16/24-bit		
Channels		8 in/4 out		
Power consumption	10 W			
External dimensions	100 mm (W) x 119.8 mm (D) x 62.9 mm (H)			
Weight	520 g			



ZOOM CORPORATION

4-4-3 Kanda-surugadai, Chiyoda-ku, Tokyo 101-0062 Japan

www.zoom.co.jp