

AVX

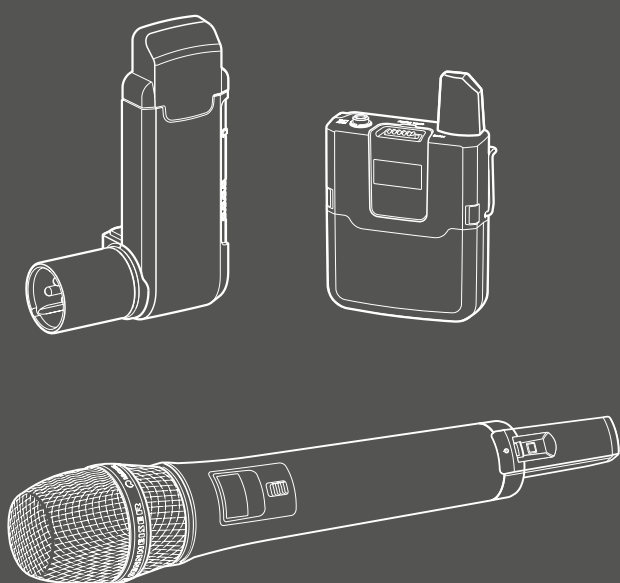

Specifications

EKP AVX

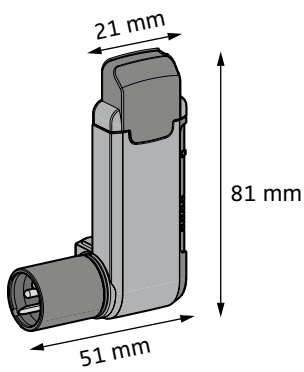

SKM AVX/SKM AVX-S

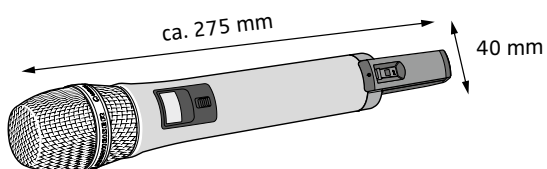

SK AVX

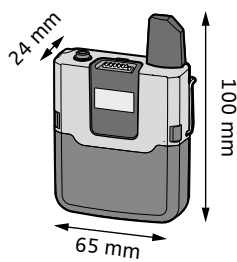

AVX Specifications

System

AF frequency response	20 to 20,000 Hz
Dynamic range	> 120 dB (A)
THD (1 kHz)	typ. 0.1 %
Audio sampling	24 bit/48 kHz
Signal-to-noise ratio	> 90 dB (A)
RF frequency ranges	1,880 to 1,930 MHz (country-specific)
Modulation	GFSK with back channel
Transmission method	TDMA fast switching antenna diversity
Latency	19 ms
Relative air humidity	max. 95 %
Temperature range*	Operation: -10 °C to +55 °C Storage: -20 °C to +70 °C

* The temperature range is influenced by the battery characteristics



EKP AVX

RF sensitivity	< -90 dBm
RF output power back channel	typ. 15 dBm e.i.r.p.
Audio output	adjustable
XLR, balanced	-30 dBu to 0 dBu in 4 steps
Power supply	BA 20 (Li-Ion 3.7 V DC)
Operating time	> 4 h
AF connection socket	XLR, male
Weight (incl. BA 20)	approx. 87 g

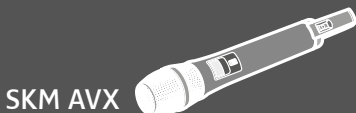

SKM AVX

RF output power	adaptive, up to 250 mW (country-specific)
AF frequency response	50 to 20,000 Hz
Input sensitivity	automatic sensitivity adjustment
Power supply	Accupack: BA 10 (Li-Ion, 3.6 V) Batteries*: 2 x AA size battery (1.5 V)
Operating time	Accupack: typ. 15 h Batteries*: typ. 10 h
Display	LCD
Weight (w/o accupack)	approx. 282 g incl. microphone head

* optional accessory

SK AVX

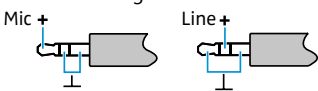

RF output power	adaptive, up to 250 mW (country-specific)
AF frequency response	Mic: 50 to 20,000 Hz Line: 20 to 20,000 Hz
Max. input level	Mic: 2.2 V RMS Line: 3.3 V RMS
Line input impedance	1 MΩ
Input sensitivity	automatic sensitivity adjustment
Power supply	Accupack: BA 30 (Li-Ion, 3.7 V) Batteries*: 2 x AA size battery (1.5 V)
Operating time	Accupack: typ. 15 h Batteries*: typ. 11 h
AF connection socket	3.5 mm jack socket, lockable connector assignment: 
Weight (w/o accupack)	approx. 87 g

* optional accessory



MMD 835-1 MMD 42-1

Microphone type	dynamic	
Sensitivity	2.1 mV/Pa	1,8 mV/Pa
Pick-up pattern	cardioid	omni-directional
Max. SPL	154 dB SPL	154 dB SPL

ME 2-2



Microphone type	pre-polarized condenser microphone
Sensitivity	20 mV/Pa
Pick-up pattern	omni-directional
Max. SPL	130 dB SPL

MKE 2





Microphone type	pre-polarized condenser microphone
Sensitivity	5 mV/Pa
Pick-up pattern	omni-directional
Max. SPL	142 dB SPL

In compliance with

Europa		Radio	EN 301406
		EMC	EN 301489-1/-6
		Safety	EN 60950-1 EN 62311 (SAR)
		RoHS	EN 50581
USA		FCC 47 CFR 15	
Canada		Industry Canada RSS 210 CAN ICES-3 (B)/NMB-3(B)	

Approved by

USA	SKM SK EKP	FCC ID: DMOSKM1G9WE FCC ID: DMOSK1G9WE FCC ID: DMOEKP1G9WE									
Canada	SKM SK EKP	IC: 2099A-SKM1G9WE IC: 2099A-SK1G9WE IC: 2099A-EKP1G9WE									
Australia/New Zealand											
Japan		 <table border="1"> <tr> <td>SKM</td> <td>R</td> <td>202-SMC049</td> </tr> <tr> <td>SK</td> <td>R</td> <td>202-SMC050</td> </tr> <tr> <td>EKP</td> <td>R</td> <td>202-SMC051</td> </tr> </table>	SKM	R	202-SMC049	SK	R	202-SMC050	EKP	R	202-SMC051
SKM	R	202-SMC049									
SK	R	202-SMC050									
EKP	R	202-SMC051									

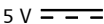

NT 5-10U

Nominal input voltage	100 to 240 V~
Power frequency	50 or 60 Hz
Nominal output voltage	5 V 
Output current	1 A
Standby power consumption	≤ 0.1 W
Energy efficiency level	V
Operating temperature	0 °C to +40 °C
Storage temperature	-20 °C to +70 °C
Relative air humidity	max. 90 %
Weight	approx. 55 g

In compliance with

Europe		EMC	EN 55022, EN 55024
		Safety	EN 60950-1
		RoHS	EN 50581
		Commision Regulation (EC) No. 1275/2008	
USA/ Canada		EMC	FCC 47 CFR 15 B ICES 003, CAN ICES-3(B)/NMB-3(B)
		Safety	UL 60950-1 CAN/CSA-C22.2 No. 60950-1
Australia		EMC	AS/NZ CISPR 22
		Safety	AS/NZL 60950.1

Certified by

Europe	ENEC 22 SIQ
USA/Canada	
Australia/New Zealand	
Japan	 センハイザージャパン(株)

Accupacks



	BA 10	BA 20	BA 30
Charging capacity	2200 mAh	430 mAh	2030 mAh
Output voltage	3.6 V	3.7 V	3.7 V

In compliance with

Europe		EMC Safety	EN 301489-1/-6/-17 IEC/EN 62133
USA/Canada		Rechargeable battery cells Accupack	UL 1642 UL 2054
Japan		DENAN Ordinance Article 1; Appendix 9 Lithium Ion	
Korea		Safety	K 62133
UN transportation test		according to UN Manual of Tests and Criteria, Part III, section 38.3 Lithium-ion batteries	

Certified by

USA/Canada



Japan



ゼンハイザージャパン(株)

Korea



Manufacturer Declarations

Warranty

- Sennheiser electronic GmbH & Co. KG gives a warranty of 24 months on this product.
- For the current warranty conditions, please visit our website at www.sennheiser.com or contact your Sennheiser partner.

FOR AUSTRALIA ONLY

Sennheiser goods come with guarantees that cannot be excluded under the Australian Consumer Law. You are entitled to a replacement or refund for a major failure and compensation for any other reasonably foreseeable loss or damage. You are also entitled to have the goods repaired or replaced if the goods fail to be of acceptable quality and the failure does not amount to a major failure.

This warranty is in addition to other rights or remedies under law. Nothing in this warranty excludes, limits or modifies any liability of Sennheiser which is imposed by law, or limits or modifies any remedy available to the consumer which is granted by law.

To make a claim under this warranty, contact Sennheiser Australia Pty Ltd, Unit 3, 31 Gibbes Street Chatswood NSW 2067, AUSTRALIA. Phone: (02) 9910 6700, email: service@sennheiser.com.au.

All expenses of claiming the warranty will be borne by the person making the claim.

The Sennheiser International Warranty is provided by Sennheiser Australia Pty Ltd (ABN 68 165 388 312), Unit 3, 31 Gibbes Street Chatswood NSW 2067 Australia.

In compliance with the following requirements

- WEEE Directive (2012/19/EU)
 Please dispose of the products at the end of their operational lifetime by taking them to your local collection point or recycling center for such equipment.
- Battery Directive (2006/66/EC)
The supplied batteries or rechargeable batteries can be recycled. Please dispose of them as special waste or return them to your specialist dealer. In order to protect the environment, only dispose of exhausted batteries or rechargeable batteries.

CE Conformity

- **CE 0682**
- R&TTE Directive (1999/5/EC)
- RoHS Directive (2011/65/EU)
- EMC Directive (2004/108/EU)
- Low Voltage Directive (2006/95/EU)

The declarations are available at www.sennheiser.com. Before putting the products into operation, please observe the respective country-specific regulations.

FCC

NOTICE:

These devices comply with Part 15 of the FCC Rules and with Industry Canada license-exempt RSS standard(s).

Operation is subject to the following two conditions:

- (1) this device may not cause harmful interference, and
- (2) this device must accept any interference received, including interference that may cause undesired operation.

Changes or modifications made to this equipment not expressly approved by Sennheiser Electronic Corporation may void the FCC authorization to operate this equipment.

NOTE: This equipment has been tested and found to comply with the limits for a Class B digital device, pursuant to Part 15 of the FCC Rules. These limits are designed to provide reasonable protection against harmful interference in a residential installation. This equipment generates, uses and can radiate radio frequency energy and, if not installed and used in accordance with the instructions, may cause harmful interference to radio communications. However, there is no guarantee that interference will not occur in a particular installation. If this equipment does cause harmful interference to radio or television reception, which can be determined by turning the equipment off and on, the user is encouraged to try to correct the interference by one or more of the following measures:

- Reorient or relocate the receiving antenna.
- Increase the separation between the equipment and receiver.
- Connect the equipment into an outlet on a circuit different from that to which the receiver is connected.
- Consult the dealer or an experienced radio/TV technician for help.

These class B digital devices comply with the Canadian ICES-003.

Japanese Radio Law and Japanese Telecommunications Business Law Compliance.

This device is granted pursuant to the Japanese Radio Law (電波法)
This device should not be modified (otherwise the granted designation number will become invalid)

Licenses

CELT Codec

Copyright (c) 2014 IETF Trust and the persons identified as authors of the code. All rights reserved.

Redistribution and use in source and binary forms, with or without modification, are permitted provided that the following conditions are met:

- Redistributions of source code must retain the above copyright notice, this list of conditions and the following disclaimer.
- Redistributions in binary form must reproduce the above copyright notice, this list of conditions and the following disclaimer in the documentation and/or other materials provided with the distribution.
- Neither the name of Internet Society, IETF or IETF Trust, nor the names of specific contributors, may be used to endorse or promote products derived from this software without specific prior written permission.

THIS SOFTWARE IS PROVIDED BY THE COPYRIGHT HOLDERS AND CONTRIBUTORS "AS IS" AND ANY EXPRESS OR IMPLIED WARRANTIES, INCLUDING, BUT NOT LIMITED TO, THE IMPLIED WARRANTIES OF MERCHANTABILITY AND FITNESS FOR A PARTICULAR PURPOSE

ARE DISCLAIMED. IN NO EVENT SHALL THE COPYRIGHT OWNER OR CONTRIBUTORS BE LIABLE FOR ANY DIRECT, INDIRECT, INCIDENTAL, SPECIAL, EXEMPLARY, OR CONSEQUENTIAL DAMAGES (INCLUDING, BUT NOT LIMITED TO, PROCUREMENT OF SUBSTITUTE GOODS OR SERVICES; LOSS OF USE, DATA, OR PROFITS; OR BUSINESS INTERRUPTION) HOWEVER CAUSED AND ON ANY THEORY OF LIABILITY, WHETHER IN CONTRACT, STRICT LIABILITY, OR TORT (INCLUDING NEGLIGENCE OR OTHERWISE) ARISING IN ANY WAY OUT OF THE USE OF THIS SOFTWARE, EVEN IF ADVISED OF THE POSSIBILITY OF SUCH DAMAGE.

Ubuntu Font License

Version 1.0

Preamble

This license allows the licensed fonts to be used, studied, modified and redistributed freely. The fonts, including any derivative works, can be bundled, embedded, and redistributed provided the terms of this license are met. The fonts and derivatives, however, cannot be released under any other license. The requirement for fonts to remain under this license does not require any document created using the fonts or their derivatives to be published under this license, as long as the primary purpose of the document is not to be a vehicle for the distribution of the fonts.

Permission & Conditions

This license does not grant any rights under trademark law and all such rights are reserved.

Permission is hereby granted, free of charge, to any person obtaining a copy of the Font Software, to propagate the Font Software, subject to the below conditions:

1. Each copy of the Font Software must contain the above copyright notice and this license. These can be included either as stand-alone text files, human-readable headers or in the appropriate machine-readable metadata fields within text or binary files as long as those fields can be easily viewed by the user.
2. The font name complies with the following:
 1. The Original Version must retain its name, unmodified.
 2. Modified Versions which are Substantially Changed must be renamed to avoid use of the name of the Original Version or similar names entirely.
 3. Modified Versions which are not Substantially Changed must be renamed to both
 1. retain the name of the Original Version and
 2. add additional naming elements to distinguish the Modified

Version from the Original Version. The name of such Modified Versions must be the name of the Original Version, with „derivative X“ where X represents the name of the new work, appended to that name.

3. The name(s) of the Copyright Holder(s) and any contributor to the Font Software shall not be used to promote, endorse or advertise any Modified Version, except
 1. as required by this license,
 2. to acknowledge the contribution(s) of the Copyright Holder(s) or
 3. with their explicit written permission.
4. The Font Software, modified or unmodified, in part or in whole, must be distributed entirely under this license, and must not be distributed under any other license. The requirement for fonts to remain under this license does not affect any document created using the Font Software, except any version of the Font Software extracted from a document created using the Font Software may only be distributed under this license.

Termination

This license becomes null and void if any of the above conditions are not met.

Disclaimer

THE FONT SOFTWARE IS PROVIDED „AS IS“, WITHOUT WARRANTY OF ANY KIND, EXPRESS OR IMPLIED, INCLUDING BUT NOT LIMITED TO ANY WARRANTIES OF MERCHANTABILITY, FITNESS FOR A PARTICULAR PURPOSE AND NONINFRINGEMENT OF COPYRIGHT, PATENT, TRADEMARK, OR OTHER RIGHT. IN NO EVENT SHALL THE COPYRIGHT HOLDER BE LIABLE FOR ANY CLAIM, DAMAGES OR OTHER LIABILITY, INCLUDING ANY GENERAL, SPECIAL, INDIRECT, INCIDENTAL, OR CONSEQUENTIAL DAMAGES, WHETHER IN AN ACTION OF CONTRACT, TORT OR OTHERWISE, ARISING FROM, OUT OF THE USE OR INABILITY TO USE THE FONT SOFTWARE OR FROM OTHER DEALINGS IN THE FONT SOFTWARE.



Sennheiser electronic GmbH & Co. KG

Am Labor 1, 30900 Wedemark, Germany

www.sennheiser.com

Publ. 01/15, 554644/A03