

Dante AV 4K Series

4K/UHD SDI/HDMI to Dante AV Ultra Transmitter
and
Dante AV Ultra to 4K/UHD SDI/HDMI Receiver



Installation and Operation Guide

Notices

Trademarks

AJA® and Because it matters.® are registered trademarks of AJA Video Systems, Inc. for use with most AJA products. AJA™ is a trademark of AJA Video Systems, Inc. for use with recorder, router, software and camera products. Because it matters.™ is a trademark of AJA Video Systems, Inc. for use with camera products.

Corvid Ultra®, Io®, Ki Pro®, KONA®, KUMO®, ROI® and T-Tap® are registered trademarks of AJA Video Systems, Inc.

AJA Control Room™, Science of the Beautiful™, TruScale™, V2Analog™ and V2Digital™ are trademarks of AJA Video Systems, Inc.

All other trademarks are the property of their respective owners.

Copyright

Copyright © 2023 AJA Video Systems, Inc. All rights reserved. All information in this manual is subject to change without notice. No part of the document may be reproduced or transmitted in any form, or by any means, electronic or mechanical, including photocopying or recording, without the express written permission of AJA Video Systems, Inc.

Contacting AJA Support

AJA Technical Support is free and available to help you answer questions or resolve issues with any of your AJA products. When calling for support, please have all relevant information at hand prior to calling.

To contact AJA for sales or support, use any of the following methods:

Email: support@aja.com

Phone: +1-530-271-3190

Web: <https://www.aja.com/support/contact>

Shipping: 180 Litton Dr. Grass Valley, CA 95945 USA

Contents

Notices	2
Trademarks	2
Copyright	2
Contacting AJA Support	2
Contents	3
Chapter 1 – Introduction	5
Overview	5
Dante AV Ultra	5
Dante Audio	5
Features	5
High Quality and Precision	5
Convenient Control	6
Compatibility	6
JPEG 2000 Video Codec	6
Video Transport & Expected Bandwidth	6
I/O Connections	7
Dante AV 4K-T Connectors	7
Dante AV 4K-R Connectors	8
LED Indicators	9
Dante AV 4K-T and Dante AV 4K-R Front Panel LEDs	9
Dante AV 4K-T Rear Panel LEDs	10
Dante AV 4K-R Rear Panel LEDs	11
Chapter 2 – Installation	12
Prior to Use	12
Unpacking	12
Physical Setup	12
Base and Surface Mount Installation	12
Rack Mount Installation	13
System Setup	13
Cabling	13
Optional Equipment to Prepare	14
Other AJA Products to Use with Dante AV 4K-T and 4K-R	14
Other Equipment	14
Required Software	15
Dante Controller Software (MacOS or Windows)	15
Installing Dante Controller	15
Uninstalling Dante Controller	16
Chapter 3 – Operation	17
Preparation	17
Power Up	17
Power up a Dante AV 4K-T or Dante AV 4K-R	17
Important Guidelines for Using the Ethernet Ports	17
Discovery and Auto-Configuration	18
Automatic Network Configuration	18
Automatic Discovery	18
Launching Dante Controller	19
Using Dante Controller	19
Introduction to the Dante Controller Application	19
Network View	20
Device View	22
Renaming Dante AV 4K-T & 4K-R Devices	27
Already Familiar with Dante Controller for Audio?	30
Video Channels are Routed like Audio Channels	30
Flows	30
Video Channels are Unicast by Default	31

Introduction to Video Multicasting	31
Routing for Video Devices	32
Unicasting	32
Multicasting	32
Audio Routing	35
Infrared: IR-Over-IP	36
Advantages of IR-Over-IP	36
Implementing IR-Over-IP	36
Serial Control over IP	38
Advantages of Serial Control Over IP	38
Implementing Serial Control Over IP	38
USB over IP	40
Advantages of USB Over IP	40
Implementing USB Over IP	40
User Presets	42
What can I do with Presets?	42
When are Presets Helpful?	42
Device Roles	42
Saving Presets	43
Applying Presets	43
Chapter 4 – Interoperability	46
Dante Applications for PC or Mac	46
Dante Controller	46
Dante Via	46
Dante Virtual Soundcard	46
Third Party Software Applications	46
Chapter 5 – Troubleshooting	47
Troubleshoot Using the Dante AV 4K-T and 4K-R LEDs	47
Troubleshoot Using the Dante Controller Application	47
Automatic Notification of Device Errors	47
On-Screen Warning and Error Indicators	47
Computer Configuration	49
Network Configuration	49
Troubleshooting Dante IP Address Configuration	49
Troubleshooting Switch Configuration and Cabling	51
Appendix A – Specifications	53
Dante AV 4K Tech Specs	53
Appendix B – Safety and Compliance	57
Warranty and Liability Information	64
Limited Warranty on Hardware	64
Limitation of Liability	64
Governing Law and Language; Your Rights	64
Index	65

Chapter 1 – Introduction



Overview

The AJA Dante AV 4K-T and 4K-R devices encode and decode video and audio streams to and from the Dante AV Ultra IP video protocol, JPEG 2000 video codec, simplifying AV signal delivery while providing an efficient way to transmit audio and video signals in sync between a wide range of devices.

Building on years of robust IP audio networks, AJA Dante AV encoders and decoders enable an easy path to upgrade your existing Dante audio network to deliver high-quality visually lossless video up to 4K/UltraHD for delivery across 1 GIG networks. AJA also offers the OG-DANTE-12GAM, an OpenGear 12G-SDI/Dante 64-Channel audio embedder/disembedder card. Now you have a powerful way to create a video and audio Dante network with high quality, precision sync with the new Dante AV 4K-T and 4K-R Dante AV Ultra devices.

Dante AV Ultra

AJA's Dante AV 4K-T and Dante AV 4K-R devices support the Dante AV Ultra standard. Dante AV Ultra delivers up to 4Kp60 at sub frame latency for the most demanding applications while still running on 1Gbps networks.

Dante Audio

Dante audio allows uncompressed, multi-channel, low latency 24-bit, 48 kHz PCM24 digital audio to be distributed across a switched Ethernet network using standard TCP/IP protocols while meeting the stringent quality requirements of professional audio. The AJA Dante AV 4K-T and Dante AV 4K-R devices provide an attractive option for integration of video and audio devices into the Dante world.

Features

High Quality and Precision

- Dante AV Ultra video using a network efficient JPEG 2000 codec.
- Dante support – allows 12G-SDI and 4K HDMI video and 8 channel embedded audio support to and from the Dante ecosystem.
- Fully time-aligned and separately routable audio and video streams.

Convenient Control

- Unified control of audio and video using Dante Controller.
- Fully validated implementation of DHCP 2.2 over IP.
- Easy control of remote devices via USB HID, serial, and IR over IP.
- Dante Controller is used to route the audio and video paths. It is also used for all Dante AV network status and configuration.
- Unique and especially useful KVM capability.

Compatibility

- Dante AV works with cost-effective 1Gbps networks.
- Direct Show driver for broad application compatibility.
- Instant compatibility with over 3,000 existing Dante-enabled audio products.
- Compatible with a range of additional optional Dante Software from Audinate including [Dante Via](#) and [Dante Virtual Soundcard](#).
- Significant Interoperability with other 3rd party video software.

JPEG 2000 Video Codec

AJA's Dante AV 4K-T and Dante AV 4K-R devices implement [JPEG 2000](#). JPEG 2000 was selected as the video coding standard for digital cinema in 2004. It supports:

- Lossy and lossless coding
- Up to 16384 components
- Bit depth up to 38 bits/sample
- Terapixel images
- Resolution and quality scalability
- Progressive decoding and sub-frame latency
- Region-of-interest accessibility

Video Transport & Expected Bandwidth

Dante video is optimized to run on Gigabit Ethernet and has a bandwidth cap of 700 Mbps. Video bandwidth is impacted by the following parameters:

- Resolution
- Frame rate
- Chroma sampling
- Color bit depth
- Compression codec used
- Content shown

Dante video flows must be Multicast if video is sent to more than one destination.

NOTE: See "[Multicasting](#)" on page 32.

I/O Connections

Dante AV 4K-T Connectors

Figure 1. Rear View of Dante AV 4K-T (Transmitter) Connectors

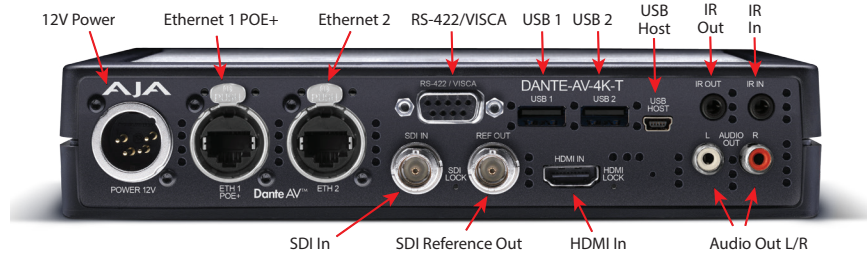

Power

- 12VDC, DIN-4 connector

Ethernet 1

- POE (+) on Primary Ethernet port
- 1 x Neutrik etherCon RJ45 Connector (Rugged)
- 1 Gbps (Dante AV & POE+)

Ethernet 2

- 1 x Neutrik etherCon RJ45 Connector (Rugged)
- (For future use)

SDI In

- 1x 12G-SDI input
- YCbCr 4:2:2 10-bit
- 8 channel embedded audio support from SDI input

Reference Out

- BNC Ref output connector (For future use)

HDMI In

- 1x HDMI 2.0 input- RGB, YCbCr, 4:4:4, 4:2:2, 8-bit, 10-bit, & 12 bit
- 8 channel embedded audio support

NOTE: For specific details and limitations, see AJA Dante AV-4K and 4K-R Video Formats document at v1.0 at <https://www.aja.com/products/dante-av-ultra#support>

Serial

- 1 x DB-9 RS-422/ VISCA Serial Port

USB

- 2 x USB 2.0 Type A Connector
- 1 x USB-Mini Host connector

IR over IP

- 3.5mm IR Out and IR In jacks for IR over IP

Audio Out

- Analog RCA Audio Monitor Outputs

Dante AV 4K-R Connectors

Figure 2. Rear View of Dante AV 4K-R (Receiver) Connectors

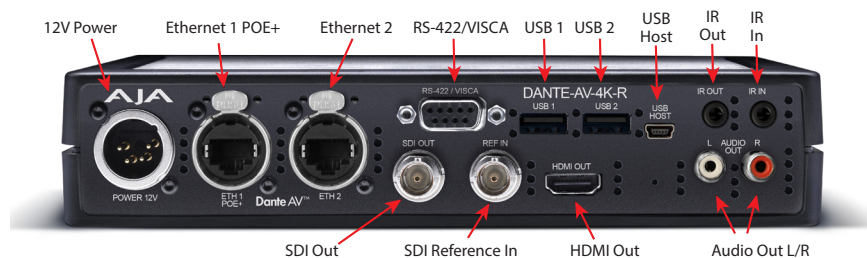

Power

- 12VDC - DIN-4 connector

Ethernet 1

- POE (+) on Primary Ethernet port
- 1 x Neutrik etherCon RJ45 Connector (Rugged)
- 1 Gbps (Dante AV & POE+)

Ethernet 2

- (For future use.)

SDI Out

- 1x 12G-SDI Output
- YCbCr 4:2:2 10-bit
- 8 channel embedded audio support

Reference In

- BNC Ref input (For future use)

HDMI Out

- 1x HDMI 2.0 output
- RGB, YCbCr, 4:4:4, 4:2:2, 8-bit, 10-bit, & 12 bit
- 8 channel embedded audio support

NOTE: For specific details and limitations, please see the AJA Dante AV-4K and 4K-R Video Formats document at v1.0 at <https://www.aja.com/products/dante-av-ultra#support>

Serial

- 1 x DB-9 RS-422/ VISCA Serial Port

USB

- 2 x USB 2.0 Type A Connector
- 1 x USB-Mini Host connector

IR over IP

- 3.5mm IR In and IR Out jacks for IR over IP

Audio Out

- Analog RCA Audio Monitor Outputs

LED Indicators

Dante AV 4K-T and Dante AV 4K-R Front Panel LEDs

Figure 3. Dante AV 4K-T and Dante AV 4K-R Front Panel LEDs



Power

- Single-color Green LED
 - Green indicates power is supplied to the board

Codec

- Single-color Green LED
 - Green indicates the codec is active

System: Dante System Status

- Tri-colour LED
 - Solid green – All OK, sync achieved
 - Amber – Booting up, awaiting sync
 - Red – System failed to boot correctly
 - Off – No power

Status: Dante Software Status

- Tri-colour LED
 - Solid green – Software running
 - Blinking green – Identify function activated
 - Solid or blinking red – Software fault or exception
 - Off – No power

Sync: Clock Synchronization Status

- Tri-colour LED
 - Solid green – Dante network clock follower, sync achieved
 - Blinking green – Dante network clock leader
 - Amber – Syncing in progress
 - Red – Error achieving sync
 - Off - No power

HDCP: Status of HDCP on the HDMI Input or Output

- Tri-colour LED
 - Solid green - non-HDCP unprotected video sync or source detected
 - Blinking green – HDCP protected content detected
 - Solid red – Invalid non-HDCP video sync or source
 - Blinking red – Failed HDCP negotiation
 - Blinking Amber – HDCP negotiation in progress
 - Off - No power

Dante AV 4K-T Rear Panel LEDs

Figure 4. Dante AV 4K-T Rear Panel LEDs

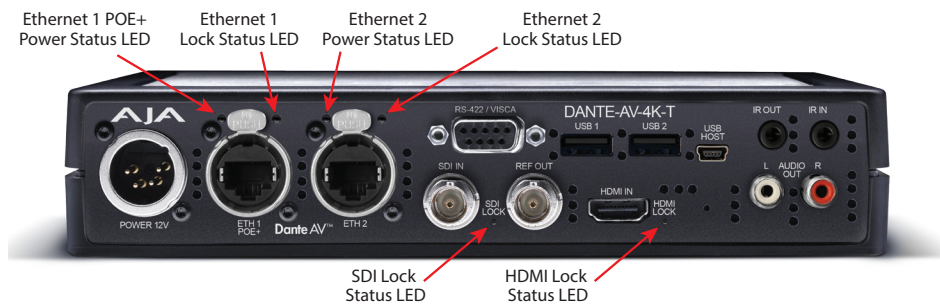

SDI Lock Status

- Green means the receivers are locked (though not necessarily a supported video format)
- Off means not locked/present

HDMI Lock Status

- Green means the receivers are locked (though not necessarily a supported video format)
- Off means not locked/present

Ethernet 1 Link Status LED

- Follows the standard ethernet lighting convention for Link LED*

Ethernet 1 Activity Status

- Follows the standard ethernet lighting convention for Status LED*

Ethernet 2 Link Status LED

- Follows the standard ethernet lighting convention for Link LED*

Ethernet 2 Activity Status

- Follows the standard ethernet lighting convention for Status LED*

NOTE: **Blinking ethernet light means that the port is transmitting information
Solid light means a connection between the devices
No light means that there is no current connection
Amber color is Gigabit connection, Green color is 100-Mbps connection*

Dante AV 4K-R Rear Panel LEDs

Figure 5. Dante AV 4K-R Rear Panel LEDs

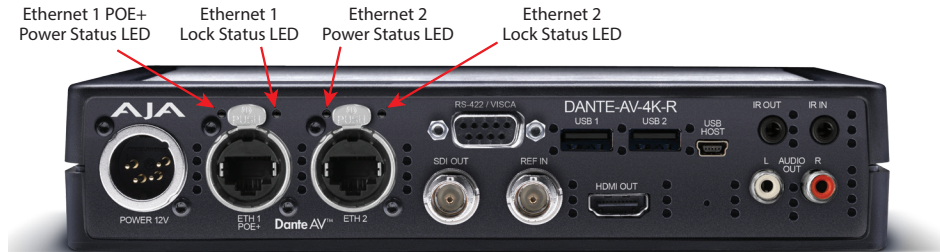

Ethernet 1 Link Status LED

- Follows the standard ethernet lighting convention for Link LED*

Ethernet 1 Activity Status

- Follows the standard ethernet lighting convention for Status LED*

Ethernet 2 Link Status LED

- Follows the standard ethernet lighting convention for Link LED*

Ethernet 2 Activity Status

- Follows the standard ethernet lighting convention for Status LED*

NOTE: **Blinking ethernet light means that the port is transmitting information
Solid light means a connection between the devices
No light means that there is no current connection
Amber color is Gigabit connection, Green color is 100-Mbps connection.*

Chapter 2 – Installation

Prior to Use

Unpacking

Unpack the Dante AV 4K-T or Dante AV 4K-R product you received and make sure that all of the items listed below in the Parts List are included. If any items are missing or damaged, contact your sales representative or AJA directly.

Parts List

Quantity	Description
1	Dante AV 4K-R or Dante AV 4K-T unit in ESD bag
1	120/240 AC to 12v DC 4-pin XLR Power Adapter
1	IR emitter on 3.5 mm cable
1	IR receiver on 3.5 mm cable
1	AJA Shipping Support Card

Physical Setup

Base and Surface Mount Installation

- The units may be attached using screws, Velcro or zip-ties.
- Make sure to mount the units in a way that maintains sufficient ventilation around them.

Figure 6. DO NOT STACK Dante AV 4K-T and/or Dante AV 4K-R units



WARNING: Do not stack multiple units directly on top of each other. This could cause overheating

Rack Mount Installation

- For either single- or double-unit rack installations, AJA's IOX-RM 1RU rack shelf is an available custom solution for the Dante AV 4K-T and 4K-R devices.
- The units are attached to the shelf using six (6) #4-40 flat head screws each on the left and/or right side of the shelf using the countersunk holes provided.

Figure 7. Single-unit mounting example using the IOX-RM 1RU rack shelf

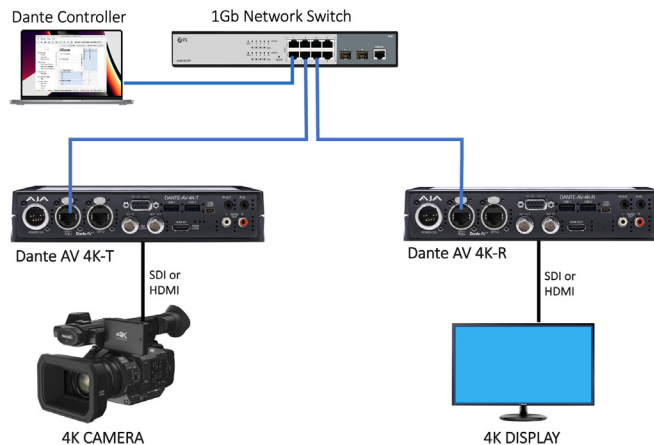

Figure 8. Dual-mounting example using the IOX-RM 1RU rack shelf



System Setup

Figure 9. A 4K Video-over-IP system using a Dante AV 4K-T and Dante AV 4K-R



Cabling

1. Connect HDMI cabling (if desired) to the Rear Panel of a Dante AV 4K-T for an HDMI Camera, and/ or to a Dante AV 4K-R for an HDMI Display.
2. Connect the BNC cables for reference (if desired) to the Rear Panel of a Dante AV 4K-T Reference OUT, or to a Dante AV 4K-R for reference IN.
3. Connect SDI cabling (if desired) to the Rear Panel of Dante AV 4K-T for a Camera, and/or to a Dante AV 4K-R for a Display.
4. Connect the Ethernet cabling to an appropriate Managed Network POE+ or POE++ Switch.
5. Connect USB 1 and USB 2 cabling to (optional) USB keyboard & mouse (if desired).
6. Connect USB HOST to a host computer (if desired).
7. Connect RCA audio cables (if desired).
8. Connect IR devices (if any).
9. Connect the approved DC Power Supply if not using POE+ for power.

NOTE: Refer to "Dante AV 4K-T Connectors" on page 7 and "Dante AV 4K-R Connectors" on page 8 to identify the input and output signal connectors.

NOTE: The Secondary Ethernet port is for future use. Dante Controller will not function correctly if both the Primary and Secondary Ethernet Ports are connected to the same network switch.

Optional Equipment to Prepare

Other AJA Products to Use with Dante AV 4K-T and 4K-R

Digital Video Playback and Recording Devices

AJA products such as the [Ki Pro Ultra 12G](#) or [Io 4K Plus](#) may be used as a playback device when connected to the Dante AV 4K-T or used as a recording device when connected to a Dante AV 4K-R.

Streaming

A [HELO Plus](#) can be attached to the SDI or HDMI output of a Dante AV 4K-R for advanced H.264 streaming to the Internet.

Video Signal Enhancement

The [FS-HDR](#) or [ColorBox](#) may be used for color enhancement and format cross-conversion with a Dante AV 4K-T and/or Dante AV 4K-R.

Other AJA Dante Equipment

The Dante AV 4K-T and 4K-R series devices can seamlessly integrate into a Dante network also using one or more [OG-Dante-12GAM](#) cards to provide up to 64-channel audio embedding/disembedding per card.

Users already familiar with AJA's OG-Dante-12GAM will feel comfortable in expanding their network into the Dante Video ecosystem, while continuing to use the same familiar Dante Controller.

The primary considerations when adding Dante AV 4K-T and Dante AV 4K-R devices onto a previously audio-only Dante network, is the speed and total device loading of the network, and the quality and type of Ethernet switches that are used.

NOTE: See [OG-Dante-12GAM](#) on the AJA website.

Other Equipment

Cameras

Suitable SDI and/or HDMI cameras may be connected to the Dante AV 4K-T unit.

TVs or Monitors

Suitable SDI or HDMI monitor displays or HDTVs for confidence monitoring may be connected to the Dante AV 4K-R unit.

Network Switches, Routers and Cabling Configuration

The network configuration must be compatible with the requirements of Dante AV.

NOTE: See <https://www.audinate.com/learning/faqs>

Required Software

Dante Controller Software (MacOS or Windows)

Dante Controller must be installed on at least one PC or Mac on the Dante network in order to control and route Dante video. Dante Controller software can be downloaded from the Audinate website: www.audinate.com.

NOTE: See the "Available Dante Video Training by Audinate" on page 52.

Hardware Component Requirements

- Processor 1GHz or better
- Memory 512Mbyte of RAM
- Network Standard wired Ethernet network interface (100Mbps or Gigabit)

Windows

- Hardware Component Requirements (shown above)
- Operating System Windows 10 or 11
- Hardware 64-bit architecture

MacOS

- Hardware Component Requirements (shown above)
- Operating System macOS 10.15, 11, 12 or 13
- Hardware Intel or Apple M1

Installing Dante Controller

Downloading Dante Controller

Dante Controller is available for download from Audinate's website. To download a copy of Dante Controller:

1. Go to the Audinate website: www.audinate.com.
2. Navigate to Products > Dante Controller.
3. Under 'Download', choose your operating system.
4. Click the red download button. This will take you to the appropriate Dante Controller release page for your operating system (Windows or MacOS).
5. You may be asked to create or log into an Audinate user account.
6. Click the link under 'File downloads' to download the Dante Controller installer.

Installing Dante Controller on Windows

Once you have downloaded the self-installing Dante Controller file, navigate to the directory where you have downloaded it (e.g. Desktop). To install:

1. Ensure you are logged on to your PC as an administrator.
2. Navigate to and double-click the Dante Controller installer file.
3. Read the license agreement. If you agree to the terms, select the 'I agree' check box and click Install. If you do not agree to the terms, click Close.
4. Confirm / acknowledge any Windows security prompts that are displayed.
5. Dante Controller will then be installed. Dante Controller will be added to the start menu, under 'Audinate'.

Installing Dante Controller on MacOS

To install Dante Controller on macOS:

1. Double-click the Dante Controller .dmg file. A drive icon will appear on your Desktop Finder window.
2. Double click on this to open.
3. Double click the Dante Controller .pkg. This will run the installer.
4. Read the license text, and if you accept the terms of the agreement, click Agree. If you do not accept these terms, click Disagree to terminate the installation.

Uninstalling Dante Controller

You should not need to uninstall Dante Controller before installing a new version. However, if you wish to uninstall Dante Controller, you may do so.

Uninstalling in Windows

Navigate to Control Panel > Programs and Features, select Dante Controller and click Uninstall.

NOTE: Two other Dante features, 'Dante Control and Monitoring' and 'Dante Discovery', may still be present in the programs list after uninstalling Dante Controller. Do not uninstall these features if they are present - they are required by other Dante software applications (for example, Dante Virtual Soundcard, and third-party Dante control applications). They will be removed automatically if they are no longer required.

Uninstalling in MacOS

Use the Uninstall tool available in the .dmg file.

Chapter 3 – Operation

Preparation

Ensure that all required preparations have been completed before attempting to operate your AJA Dante AV 4K-T and/or Dante AV 4K-R device.

NOTE: See "[Installation](#)" on page 12.

Power Up

Power up a Dante AV 4K-T or Dante AV 4K-R

- Attach the included 12V DC Power Supply; or
- Provide power over ethernet to the Ethernet 1 connector, POE+ compliant

NOTE: Be sure to follow the Important Guidelines below.

Important Guidelines for Using the Ethernet Ports

When Using 12V DC Power Adapter

- ETH1 (Ethernet 1) is primary DanteAV network connection
- ETH2 (Ethernet 2) is a loop-through Dante (not AV) connection meant to connect to an additional Dante Audio-only device. This port should never be connected to the same LAN/VLAN as ETH1

When Using POE+ on Ethernet 1

- ETH1 (Ethernet 1) is primary DanteAV network connection and the POE+ connection
- For future use. This port should never be connected to the same LAN/VLAN as ETH1

Discovery and Auto-Configuration

When a Dante-enabled device is connected to an IP/Ethernet network, it will automatically:

1. Configure its IP address
2. Announce itself to allow automatic discovery

Within seconds of a Dante-enabled device connecting to a network, Dante Controller will automatically discover and display the device, allowing you to configure channels and route media.

Automatic Network Configuration

A Dante-enabled device connected to a network will automatically setup its own network configuration, including its IP address.

If the network has a DHCP server, which may be the case for installed networks, it will receive its IP configuration using the standard DHCP protocol.

On a network without a DHCP server, which may be the case for temporary or smaller networks, the Dante-enabled device will automatically assign itself an address using link local protocols, in the same way PCs and printers often do.

Dante devices use DHCP for addressing when available or will auto-assign an IP address in the 169.254.0.0/16 range on the primary network and 172.31.0.0/16 on the secondary network if DHCP is not available. Dante devices continue to look for a DHCP server even after auto-assigning an IP address. Most Dante devices support static IP addressing.

Automatic Discovery

A Dante-enabled device will announce information about itself to other Dante devices and Dante Controller, including:

- Device name
- Channel names
- Number of channels
- Sample rates and bit depths

This information can be seen when viewing a device on Dante Controller, and allows Dante devices to determine compatibility with other devices, such as compatible sample rates to allow media to be routed.

Launching Dante Controller

1. Launch the Dante Controller application on your PC or Mac. See ["Starting up Dante Controller" on page 49](#).
2. Establish that Discovery and Auto-Configuration have been successful and devices are seen on the network.

NOTE: If not successful, see ["Troubleshooting Dante IP Address Configuration"](#).

3. Check to make sure that all of your Dante Controller configurations and settings are as desired, by checking the various tabs in Network and/or Device Views. See the sections which follow below.
4. Verify that your intended video and/or audio signals are being sent and connected* to the Dante AV 4K-T source device (if any).

*NOTE: *If not successful, see the ["Troubleshooting"](#) on page 47*

Using Dante Controller

Use the Dante Controller application to set up the audio/video routing between Dante devices, control the audio/video connections in the Dante setup, and move audio and video in real-time over an Ethernet network. Dante Controller is also used for configuring certain network settings and for monitoring network status.

Introduction to the Dante Controller Application

The Dante Controller application is organized into two main 'views': Network View and Device View. Both views may be open at the same time in their separate windows. Each view has a menu bar, a button toolbar, and several available tabs. In this introductory section we illustrate just one or two tabs for each view.

Below is a basic setup having one AJA Dante AV 4K-T plus one AJA Dante AV 4K-R device as they initially appear after launching Dante Controller. In figure 10 below, the default factory-assigned AJA Dante device names are shown.

NOTE: In many of the remaining Dante Controller screenshots in this manual, we have renamed the devices with a simpler name. Please see ["Rename Device" on page 22](#) for more information about this.

Figure 10. The Dante Controller Application (default Network View)

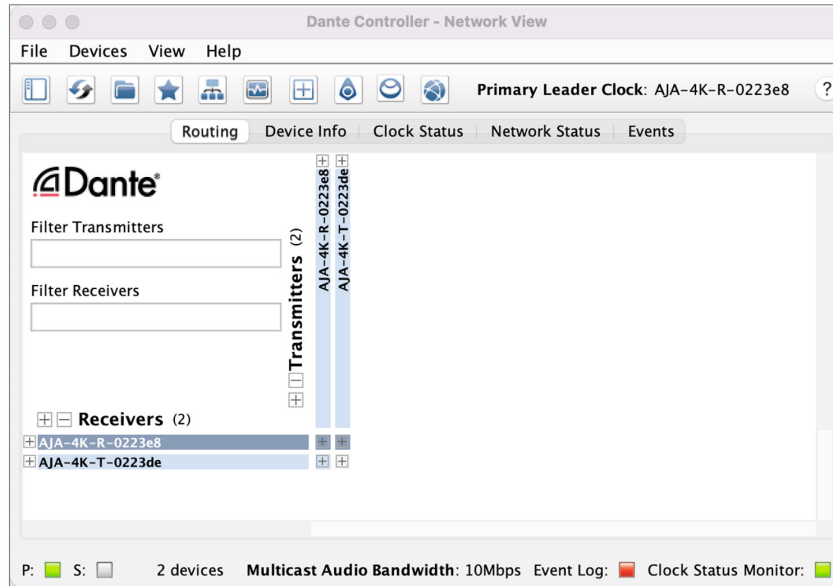

NOTE: See the AJA Audinate Dante Controller Guide for more detailed information

Network View

Routing Tab

Below is an expanded form of the Network View's Routing Tab for a two-device setup, highlighting the main user interface elements. The Advanced Filter pane has been opened and Show Channel Groups has been activated, both accomplished by clicking on their respective toggle icons in the main Toolbar.

In this example all available channels of the Dante AV 4K-T are connected to available receive channels of the Dante AV 4K-R. The channel types include one video channel, eight audio channels and three auxiliary channels for IR, Serial and USB peripherals.

NOTE: While all three auxiliary channels are shown below as being connected at once, typically one or the other at a time are used.

Figure 11. The Dante Controller Application (default view)

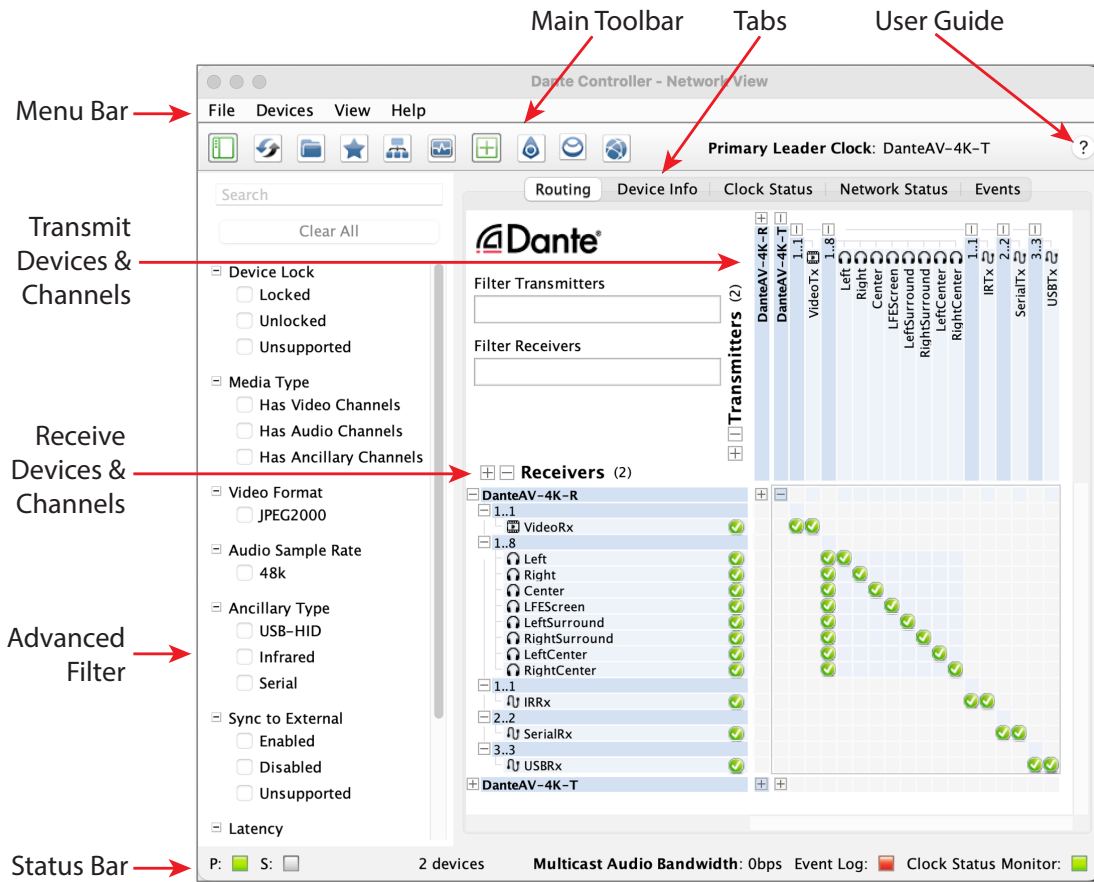

The Routing Tab allows the user to:

- Route audio, video and auxiliary channels between devices
- Simply click in any cell of the routing 'grid' where a transmit channel and a receive channel intersect, to make a connection between them
- View the status of existing routes
- View multicast bandwidth across the network
- Filter device lists by name, sample rate, latency and other parameters

NOTE: See the AJA Audinate Dante Controller Guide for more detailed information

Device Info Tab

- View all Dante-enabled audio and Dante AV Ultra devices and their channels on the network
- Device Name and Model Name
- Device Clock Status
- Device Product Version and Dante Version
- Device Lock status
- Primary and Secondary IP Addresses
- Primary and Secondary Link Speeds

Figure 12. Network View Device info Tab: all Devices on the Dante Network

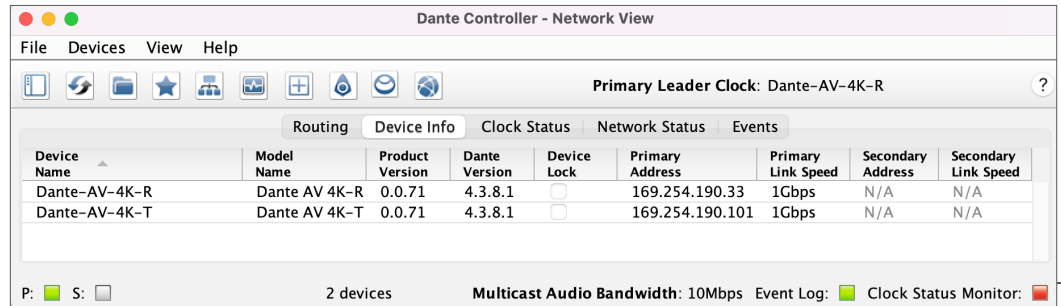

Device View

Device Config Tab

- Rename Device
- Sample Rate
- Encoding
- Clocking
- Device Latency
- Audio/Video Sync
- Reset Device (Reboot)

Figure 13. Device View: Device Config Tab

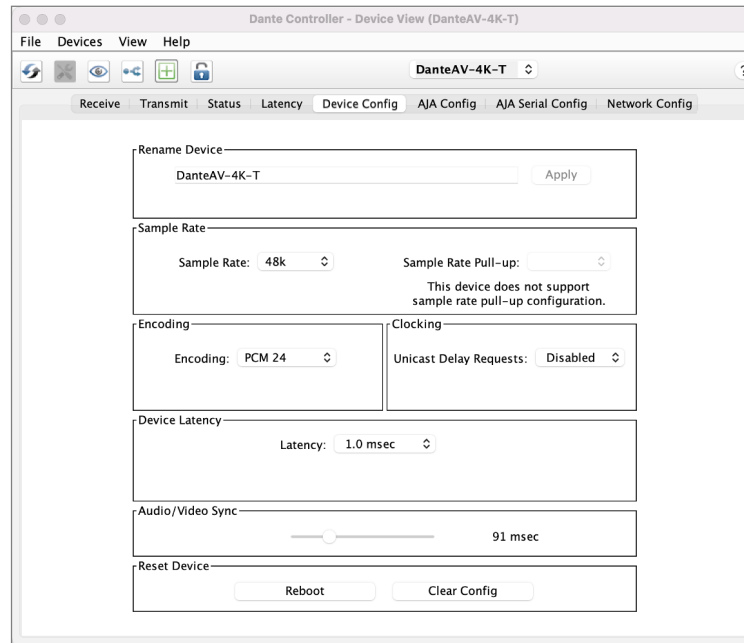

AJA Config Tab

Use the AJA Config Tab to adjust and save audio and video controls for the Dante AV 4K-T and 4K-R units, and to view status and other information.

The AJA Config tab appears differently for Dante AV 4K-T vs. Dante AV 4K-R devices. Once you have navigated to either unit's AJA Config screen, you can easily switch back and forth between them.

Since this is the primary control window for Dante AV 4K-T & 4K-R devices, we include the exact steps below to open it without any prior experience with Dante Controller.

Opening AJA Config Tab for Dante AV 4K-T

1. Launch Dante Controller. The Network View window opens.
2. Click the Device Info tab.
3. Double-click on whichever Dante AV 4K-T device that you wish to view controls for.
4. In the Device View window that opens, select the AJA Config Tab.
5. Use the Change Device menu to switch back and forth between Dante AV 4K-T devices on your network while keeping the AJA Config Tab open.
6. View or use the AJA Config tab controls as needed for each Dante AV 4K-T device on the network (see below).

Figure 14. Navigate to AJA Config Tab for Dante AV 4K-T

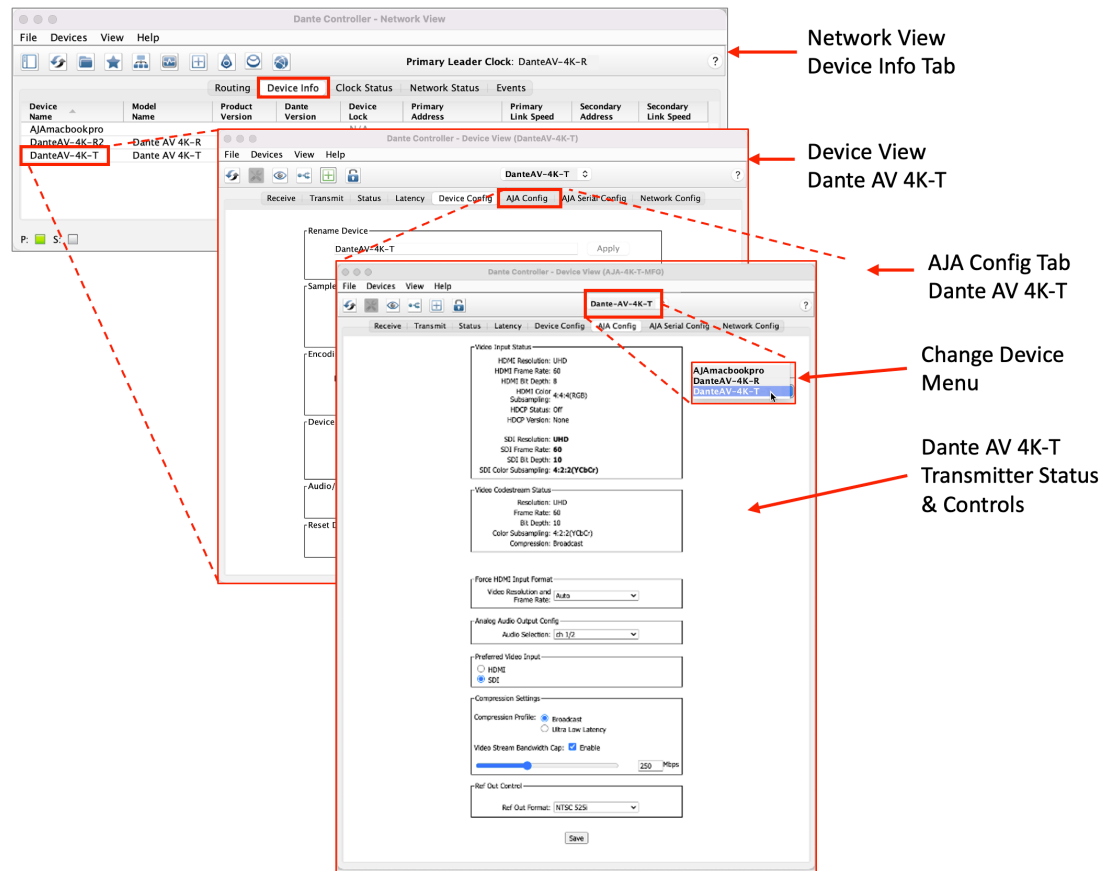

Dante AV 4K-T AJA Config Controls

- **Video Input Status:** The Video Input Stats will provide you with various information that is very helpful for integrating these units into a Dante AV workflow to confirm compatibility with other devices. It also will confirm that a valid signal is being sent to the Dante AV-4K-T. When an active is

signal being sent to both the HDMI & SDI inputs, the preferred device will be indicated by the bold font of the status information.

- **Video Codestream Status:** The Video Codestream Status will display how the signal will be received by the JPEG 2000 Codec. This may or may not match the exact bit depth or color subsampling that is output from the Receiver' Codestream Status or Video Output Status.
- **Force HDMI Input** - The Force HDMI Input can be used to force the desired Resolution and Frame rate to the 4K-T if the original source is sending out an undesirable format and the settings can't be changed at the source.
- **Analog Audio Output Config** - Select Analog Audio Channels (1/2; 3/4; 5/6; 7/8). The Audio Config allows you to select a pair of audio channels from the eight possible channels of audio from the SDI or HDMI input source (4K-T) or the SDI or HDMI Output (4K-R) that can be monitored from RCA audio output connectors on the device.
- **Preferred Video Input** - (HDMI/SDI) The Preferred Video Input is used to determine which source should be used when both an HDMI and an SDI signal are being inputted into the device. The default will be HDMI unless the user selects SDI or only a valid SDI Input is detected.
- **Compression Settings** - the factory default setting is 250Mbps.
- **Reference Out (Ref Out) Control**

Figure 15. Device View AJA Config Tab (for a Dante AV 4K-T)

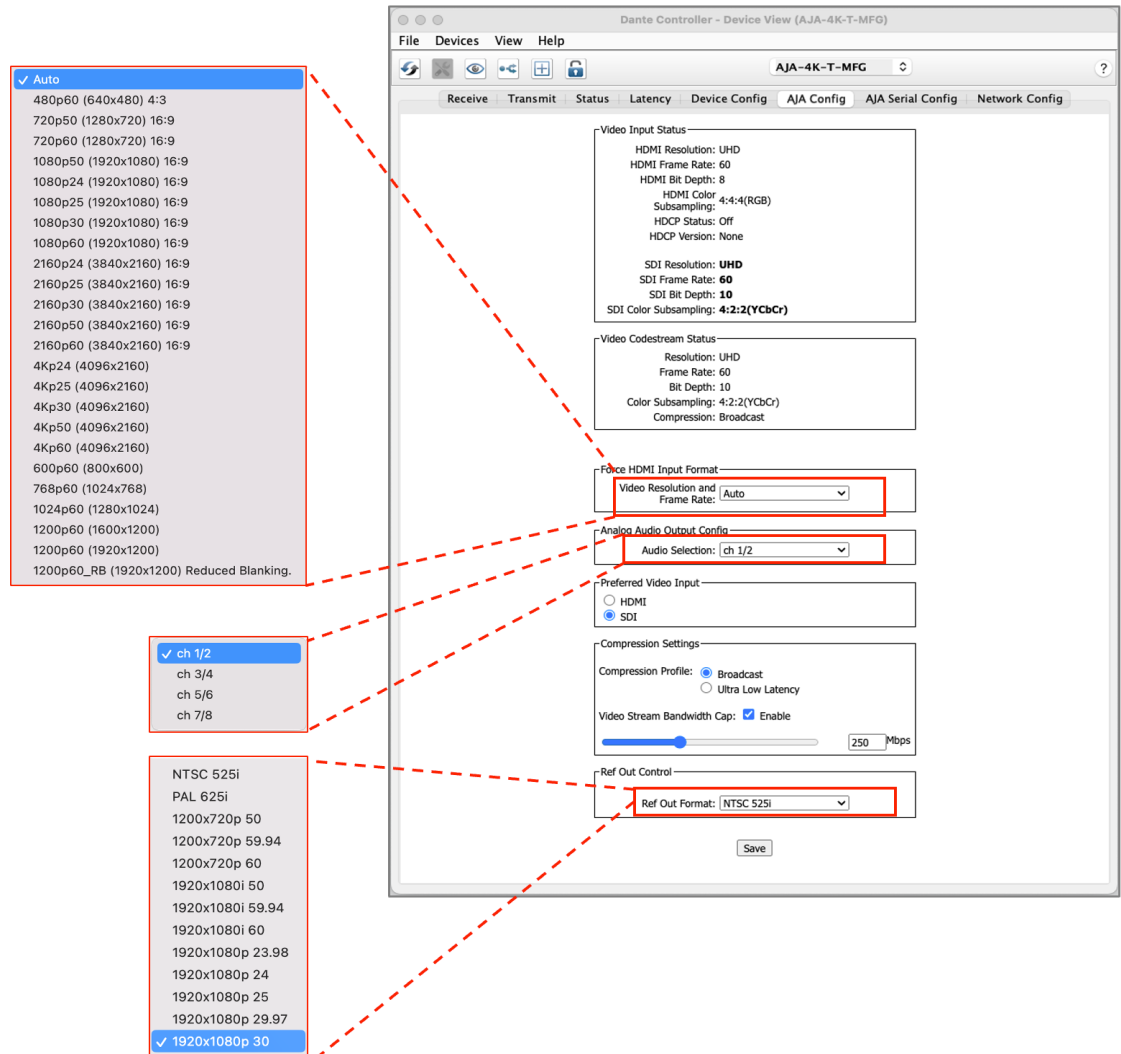

Opening AJA Config Tab for Dante AV 4K-R

1. Launch Dante Controller. The Network View window opens.
2. Click the Device Info tab.
3. Double-click on whichever Dante AV 4K-R device that you wish to view controls for.
4. In the Device View window that opens, select the AJA Config Tab.
5. Use the Change Device menu to switch back and forth between Dante AV 4K-R devices on your network while keeping the AJA Config Tab open.
6. View or use the AJA Config tab controls as needed for each Dante AV 4K-R device on the network (see below).

Figure 16. Navigate to AJA Config Tab for Dante AV 4K-R

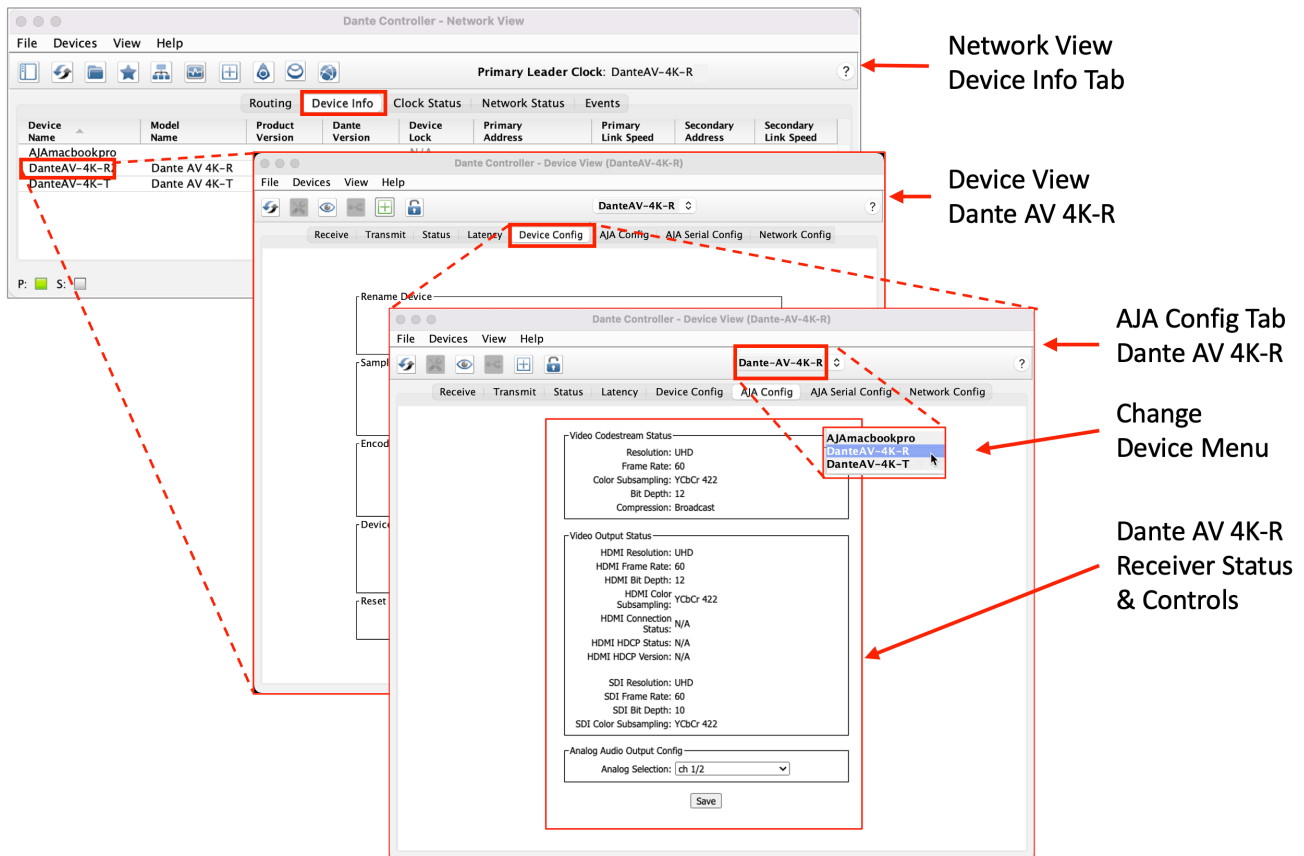

Dante AV 4K-R AJA Config Controls

- **Video Codestream Status** - The Video Codestream Status will display how the signal will be changed by the JPEG 2000 Codec. This may or may not match the exact bit depth or color subsampling that is output from the Transmitter's or Receiver's Codestream Status or Video Input or Output Status.
- **Video Output Status** - The Video Output Status will provide you with various information that is very helpful for integrating these units into a Dante AV workflow to confirm compatibility with other devices. It also will confirm that a valid signal is being sent to the Dante AV-4K-R. Both the HDMI & SDI outputs will provide information when actively connected to a valid output.
- **Analog Audio Output Config** - Select Analog Audio Channels (1/2; 3/4; 5/6; 7/8). The Audio Config allows you to select a pair of audio channels from the eight possible channels of audio from the SDI or HDMI input source (4K-T) or the SDI or HDMI Output (4K-R) that can be monitored from RCA audio output connectors on the device.
- **Save settings**

Figure 17. Device View AJA Config Tab for a Dante AV 4K-R

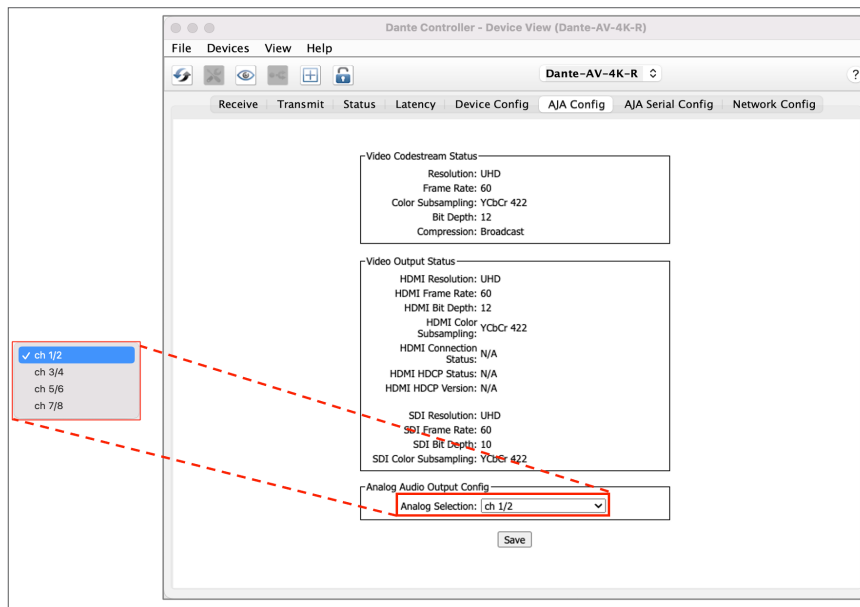

Renaming Dante AV 4K-T & 4K-R Devices

When starting to use Dante Controller a good practice is first to rename the Dante AV 4K-T and 4K-R device(s). The factory device names include six digits at the end (taken from the factory-assigned MAC address). If there are many devices on your network, long device names will cause more window pane scrolling.

A Dante AV 4K-T or 4K-R device name can be chosen to fit the device's location and use. A name also can be more compact, which is helpful when there are many devices on the Dante network. Renaming your device(s) before creating connections (see is a good idea, since doing later takes a little more care.

NOTE: Renaming a Dante device will 'break' (essentially, delete) all existing routes to and from that device (if any). Therefore if routes do exist prior to renaming, having a record of those routes helps in restoring them after the device has been renamed.

Renaming Devices in Dante Controller

1. Launch Dante Controller, if not already open.
2. In the default Network View Routing Tab, double-click on the Dante Device you wish to rename, to open its Device View.
3. In the Device View window, click on the Device Config tab to open it.
4. In the Rename Device Field, type in the new device name.

NOTE: Follow the "Rules for Device & Channel Names" on page 29.

Figure 18. Renaming a Dante AV 4K-R Device

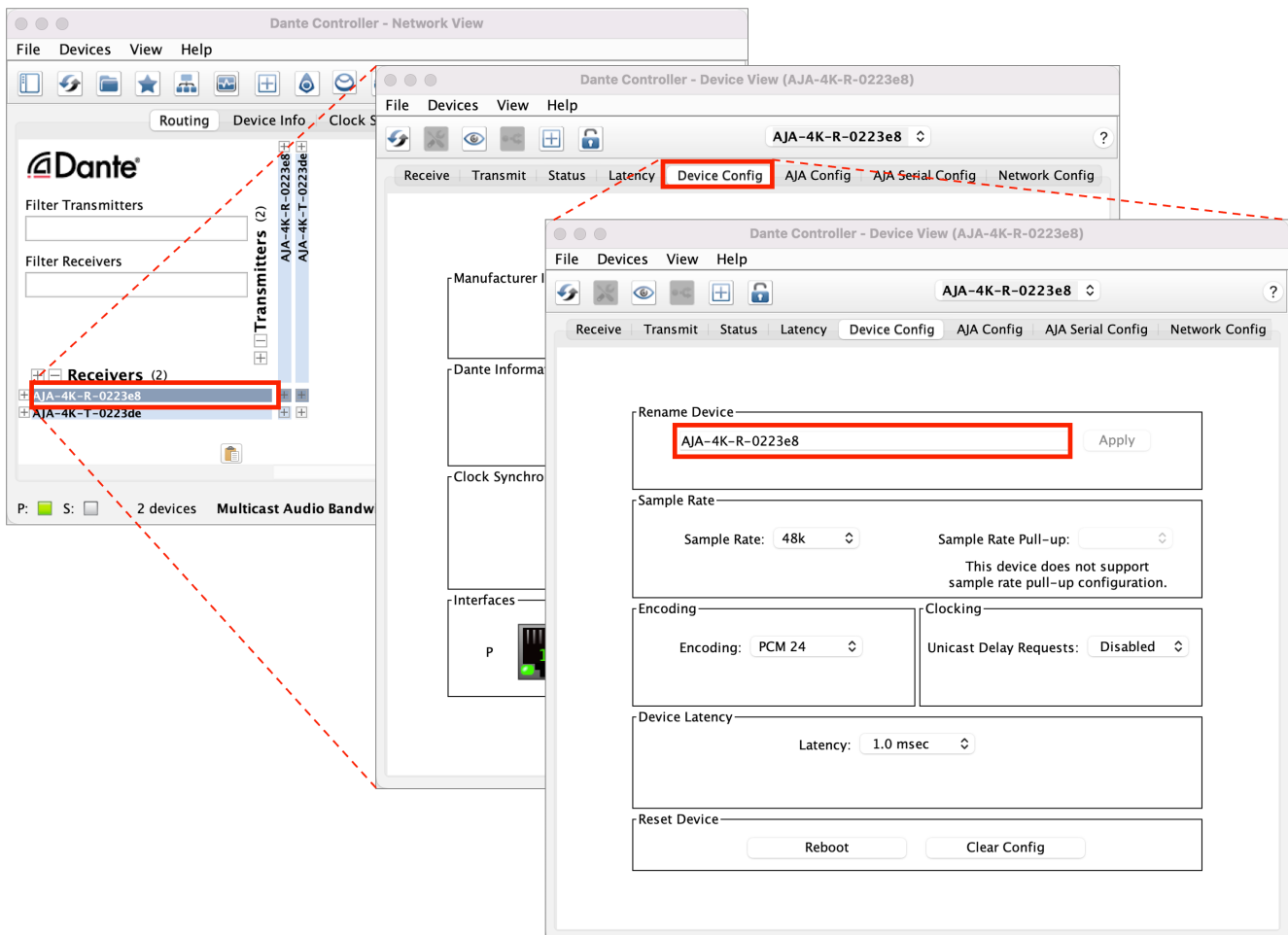

- Click Apply.
- When the confirmation dialog appears as shown in figures 19 and 20 below, if you accept the implications of having to subsequently re-define any previously enabled routes, click 'Yes'.

Otherwise, click 'No' in order to provide an opportunity to first make note of your previously existing connections, then return to the beginning of this procedure armed with those notes. This will allow you to easily restore the same connected routes (to the extent that is desired) while using the new device names.

Or, click 'No' if your network is very large and very complex with many devices and many routes, to decide that you do *not* wish to rename the device(s) in order to avoid future connection issues across the network.

Figure 19. Confirm Dante Device renaming dialog

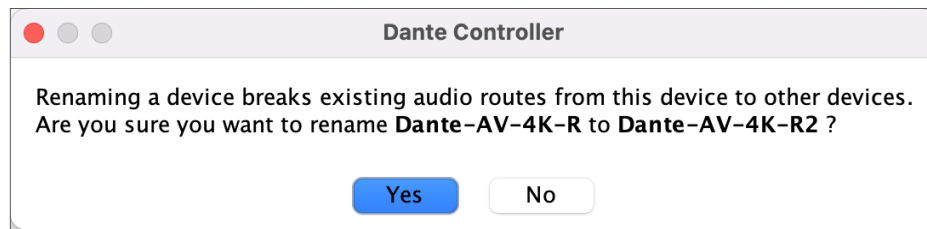

NOTE: No reboot of an AJA Dante AV 4K-T or Dante AV 4K-R device is required after the device has been renamed. The Dante Controller application will immediately refresh its windows with the new device names.

- In the Network View window that is still open, previous channel connections to and/or from the renamed device may now be manually restored (and/or new ones added).

Repeat the above Steps #2 through #7 for each additional Dante AV 4K-T or Dante AV 4K-R device that you wish to be renamed.

Figure 20. Complete Renaming a Dante AV 4K-R Device

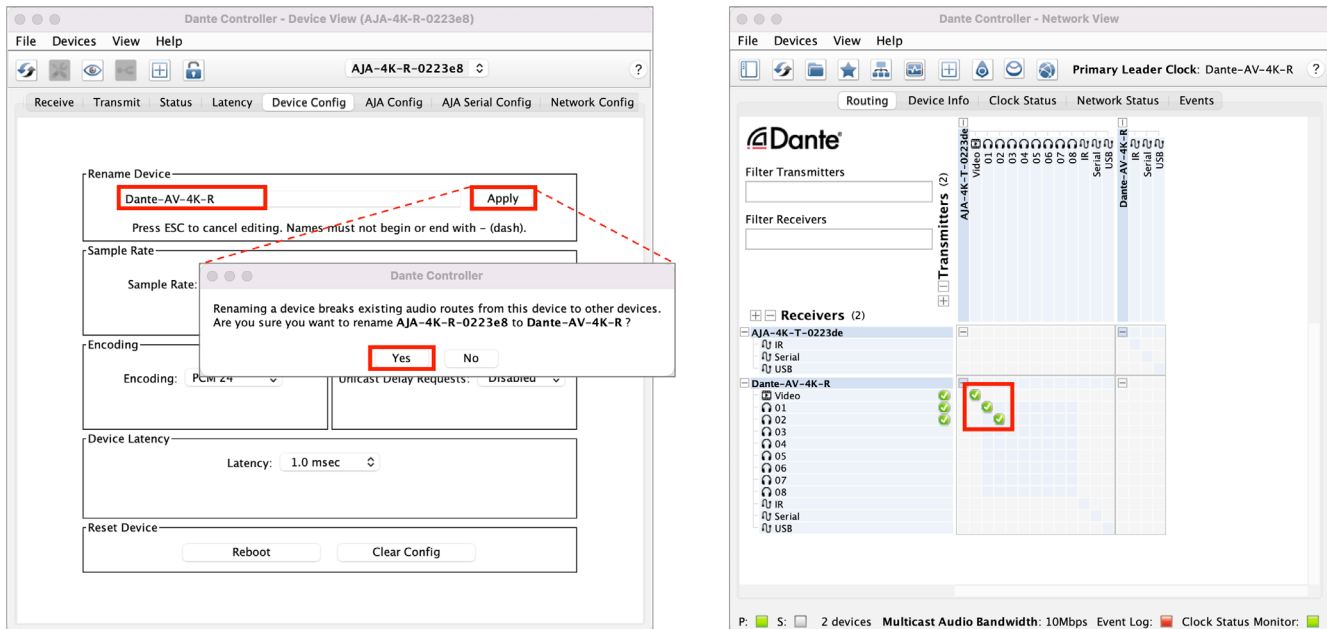

Rules for Device & Channel Names

When renaming a Dante device, be sure to always follow these rules.

- All Dante names are up to 31 characters in length.
- Name comparisons are case-insensitive: "Guitar" and "guitar" are treated as the same name.
- Unicode and non-roman characters are not supported.
- Device names should follow Domain Name System (DNS) hostname rules. Legal characters are A-Z, a-z, 0-9, and '-' (dash or hyphen).
- Device names cannot begin or end with a hyphen.
- Device names must be unique on the network.
- Tx channel names may use any character except '=' (equals), '.' (full stop or period), or '@' (at).
- Tx channel names must be unique on a device. Tx channel names do not need to be unique on the network, as they are always qualified by device (channel@device).
- Rx channel names follow the same rules as Tx channel names

NOTE: [See the AJA Audinate Dante Controller Guide at aja.com.](http://www.aja.com)

Already Familiar with Dante Controller for Audio?

Video Channels are Routed like Audio Channels

Figure 21. Routing Tab showing Dante AV 4K-R receiving video and audio channels from a Dante AV-4K-T.

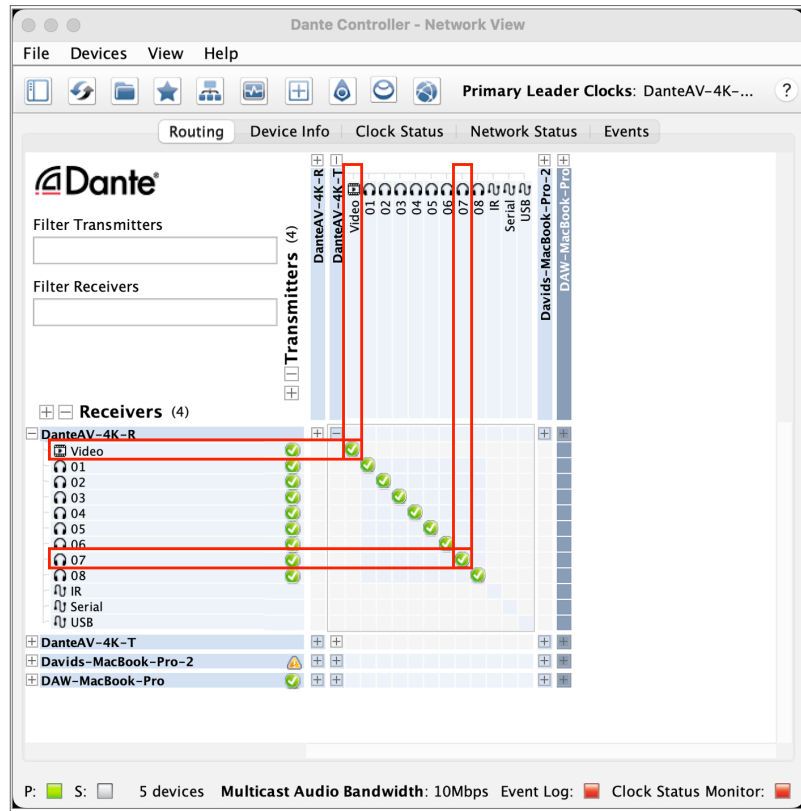

In the above example, we highlight where the Video transmit channel from a Dante AV 4K-T is routed to the Video receive channel of a Dante AV 4K-R. This is done in the same way as audio channels. Simply 'click' at the cross-connection point in the grid, and various icons appearing there will indicate the ongoing status of that route. Above, we show that the connections are good and without errors, therefore the green 'check-mark' icon appears.

Flows

Dante media routing creates 'flows'. Each flow carries one or more channels of audio, or one channel of video from a transmitting device to one or more receiving devices. There are two types of flow, unicast and multicast. Unicast routing creates flows to a single receiving device; a unicast flow typically assigns space for 4 channels of audio, or 1 channel of video.

Unicast flows are set up when a receiver subscribes to an available media channel, and are automatically removed when the receiver unsubscribes from all channels in that flow. Multicast routing creates flows that can be received by multiple receivers. Multicast flows are assigned IDs, enabling them to be identified in Dante Controller, and to facilitate their removal. In contrast to unicast flows, multicast flows must be set up on the transmitting Dante device before receivers can subscribe to these flows.

Video Channels are Unicast by Default

A difference between routing video vs. audio channels in Dante Controller, is that by default you may only connect one video channel subscriber to any given video channel source..

Introduction to Video Multicasting

Multiple video subscribers may connect to a single Video source, once that source has been setup to Multicast. When Multicasting a Video source such as from a Dante AV 4K-T, Dante separates the audio and video (even if originally embedded in the video). Multicast Video and Audio channels are thus routed separately. The Dante network seamlessly and automatically maintains time synchronization between these related audio and video channels.

NOTE: See the Video Routing and Multicasting sections below.

Routing for Video Devices

Unicasting

By default, all video 'subscriptions' (connections) are unicast. That means, as soon as one video destination subscribes to a source, it preempts any others from also subscribing. Without Multicast, attempting to add a second Video channel subscriber (such as another Dante AV 4K-R), the video from the Dante AV 4K-T fails to gain the second subscriber and the Routing Tab shows the red "blocked" icon for that connection:

Figure 22. Network View Routing Tab - a blocked unicast subscription

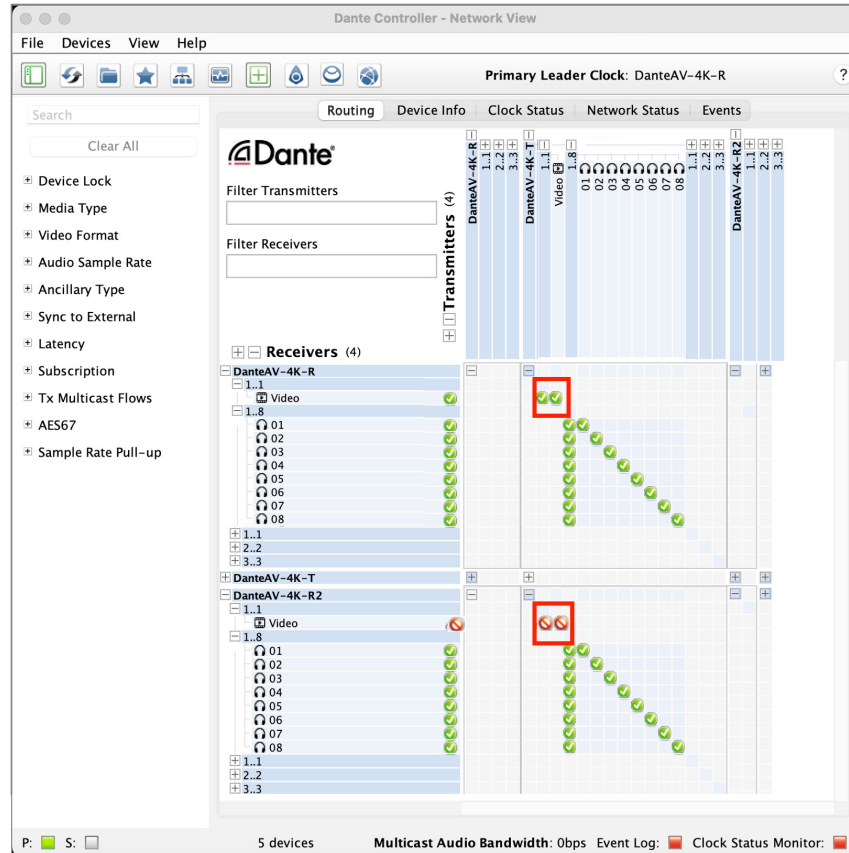

Multicasting

Dante routing is unicast by default. This means that a separate flow is set up between each transmitter and receiver. If several receivers are all subscribed to the same channels of a transmitter, it may sometimes be more efficient to use multicast. See ["Simple Example of Multicasting" on page 28](#) below.

Multicast sends the same set of channels to multiple receivers. In practice, this usually means that the flow is flooded throughout the network. If many receivers want the same channels, using multicast can reduce overall network use, especially on the transmitter, because only one copy of each channel needs to be sent, rather than many. Dante receivers will automatically prefer multicast to unicast if it is available. This means that if a new multicast flow is created containing the channels that a receiver is currently receiving as unicast, the receiver will switch over to receiving media from the multicast flow and the unicast flow will be removed.

Create a Multicast

You may easily create a 'Multicast' whereby any number of Dante video receivers on the network may simultaneously subscribe to a Video and audio channels such as from a Dante AV 4K-T.

1. From the Network View open the Device Info Tab.
2. Double-click on DanteAV-4K-T device to open it's Device View Window.
3. Click on the Create Multicast button on the Device Views Main Toolbar
4. You'll notice in the window that opens, no channels have yet been assigned to the new multicast.

Figure 23. Opening the Create Multicast Window

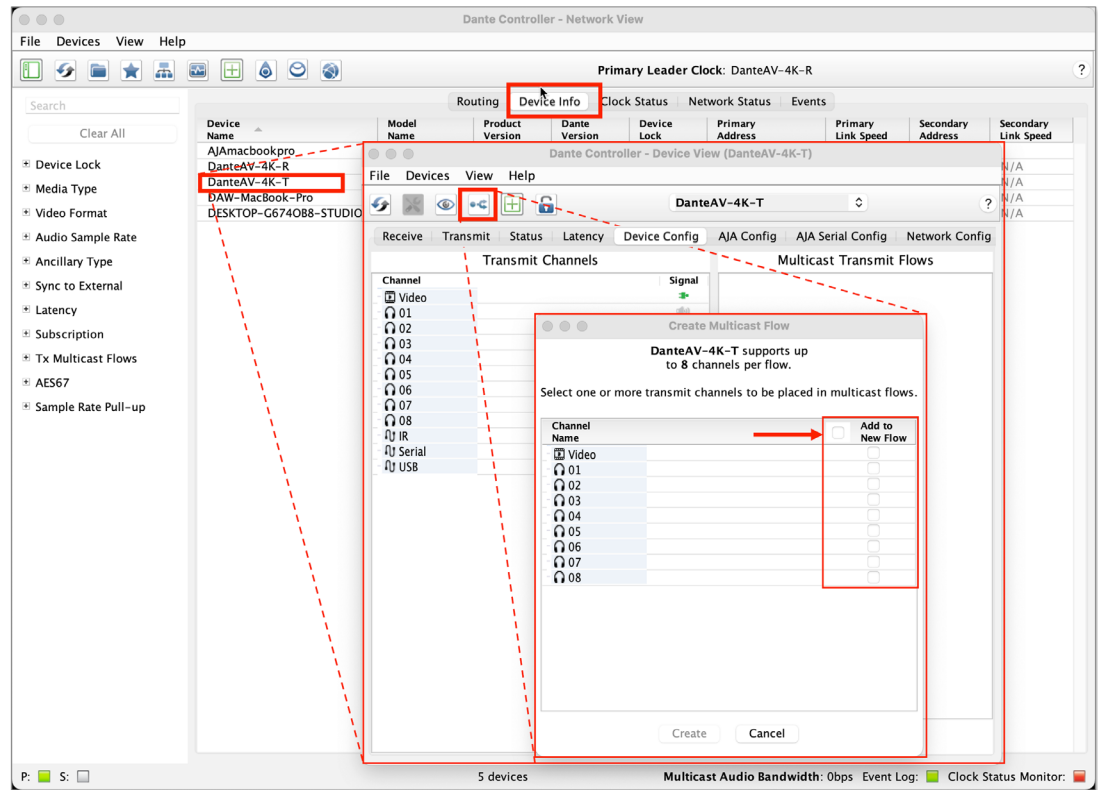

5. Check all the channels that you wish to be included in the new Multicast.

Figure 24. Adding Channels to a Multicast

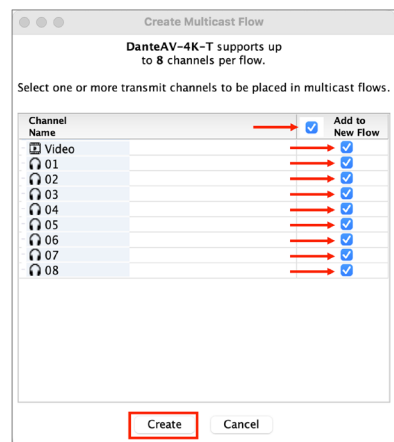

6. Click the Create Button to create the multicast.

7. You return to Device View now with the Multicast Transmit Flows pane populated with the new Multicasts.

Separate Multicasts were created for the Video and eight audio tracks.

Figure 25. Multicast Flows Created

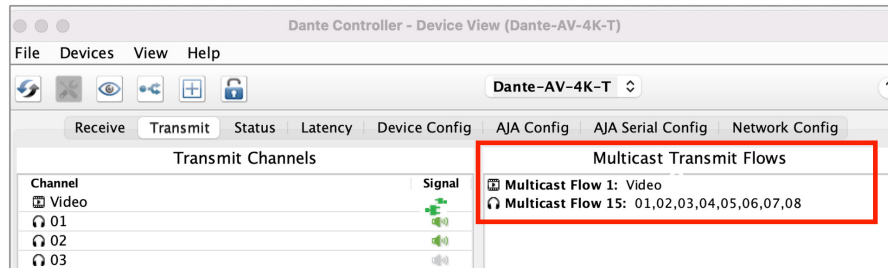

Routing Video With Multicast

Once you have created a Multicast, you will find in the Network View Routing Tab that you can add more than one Video subscriber to a Dante AV 4K-T's Video source. In this example the Multicast video and 8 audio channels are subscribed to by a Dante AV 4K-R and also by a second Dante AV 4K-R(2).

NOTE: Dante AV 4K-T and 4K-R devices may be optionally renamed which is useful when there are multiple on the network. See "Rename Device" on page 22.

You can see that both subscriptions are simultaneously allowed from the green check-marks.

Figure 26. Multicast Flows Created - Network View Routing Tab Subscriptions

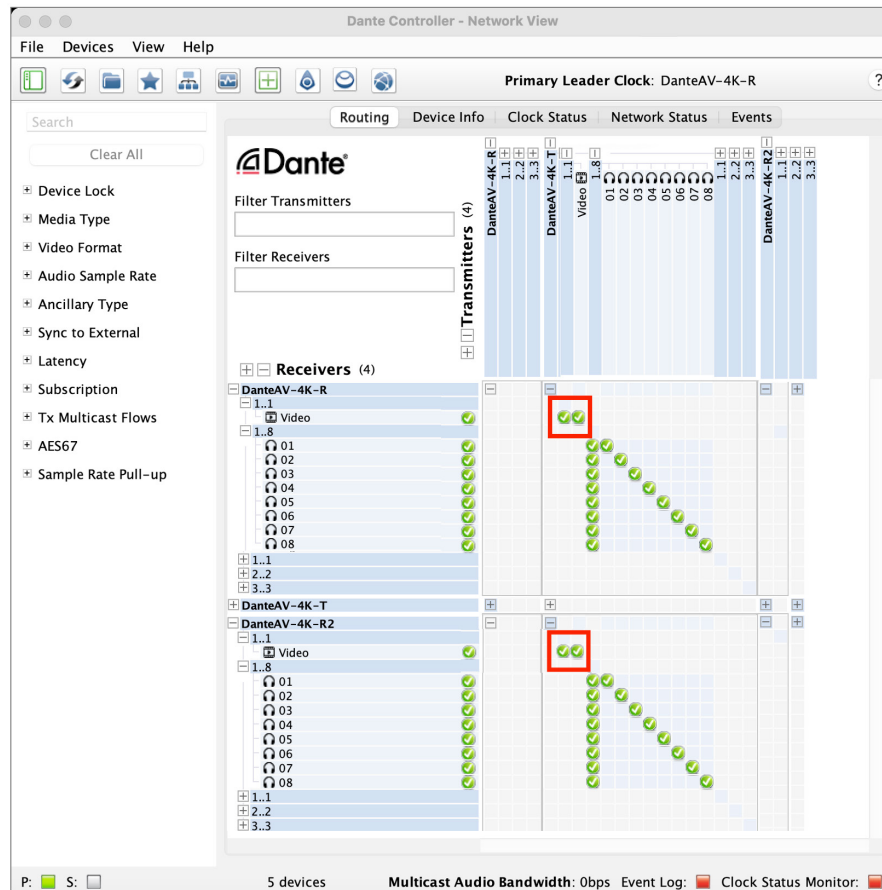

Simple Example of Multicasting

In this example, a Dante AV 4K-T with a 4K camera is sending video and audio to one Dante AV 4K-R is being used for an 4K confidence display in a control room, and a second Dante AV 4K-R is connected to an HDMI 4K Projector in another room or building.

NOTE: For simplicity all Dante AV 4K-T and Dante AV 4K-R devices are shown below as connected to the same network switch. In common practice a remote (#2) Dante AV 4K-R unit (such as one located in another building) would likely be connected to another intervening network switch.

Figure 27. Multicasting showing two different Dante AV 4K-R's receiving video and audio from one Dante AV-4K-T over a 1 GigE Ethernet network.

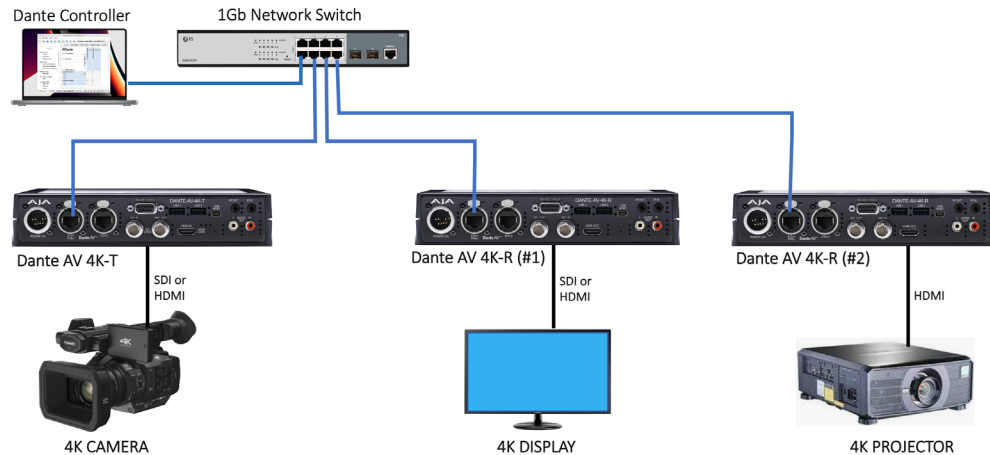

Audio Routing

With the thousands of Dante-compatible audio devices available, a comprehensive consideration of audio routing is beyond the scope of this manual. However, some examples in our Mini-Guide do show additional audio routing scenarios together with the video routing illustrated. This shows the interoperability of Dante AV 4K-T and Dante AV 4K-R devices with Dante audio-only devices including Audinate's software solutions for Dante audio (such as the Dante Via application).

NOTE: See ["Available Dante Video Training by Audinate" on page 52](#)

NOTE: See [Audinate's Dante Controller User Guide](#) for additional information.

Infrared: IR-Over-IP

Advantages of IR-Over-IP

IR-over-IP is an extremely useful feature on the Dante AV 4K-T and Dante AV 4K-R devices.

- Any network-connected pair of either Dante AV 4K-T or Dante AV 4K-R units when routed together in Dante Controller, provide for IR remote control across the Dante network.

This can be vital for media equipment that is unmanned at its location, and which otherwise has no other practical remote control method for the required functions over the long physical distance involved.

Useful IR-over-IP connected media equipment includes:

- Media Players
- Video Projectors
- Other AV Equipment

Implementing IR-Over-IP

IR Specifications

- 3.5 mm 2-pin connector
- 38kHz Carrier Frequency
- 3.3V to 5V Supply Voltage

IR-Over-IP: Setups

Figure 28. IR-over-IP through a Dante AV 4K-R

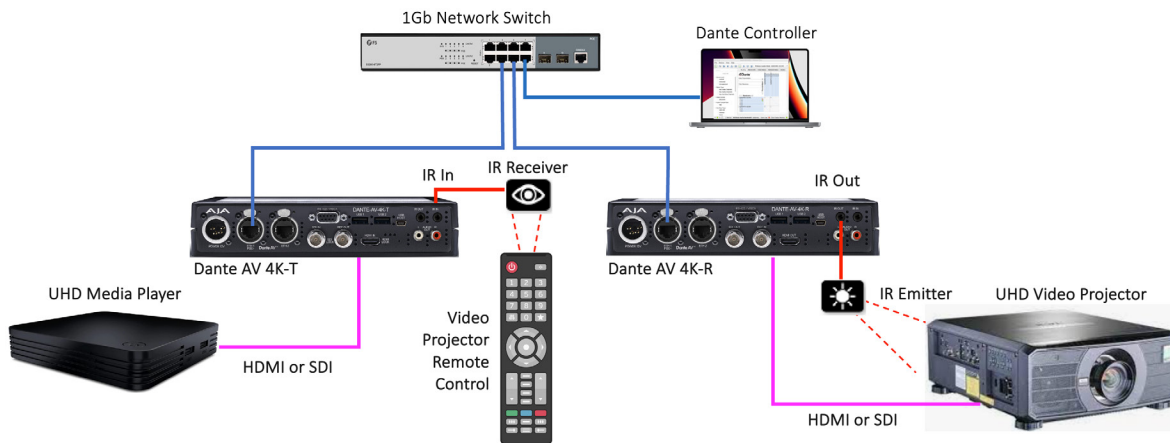

NOTE: See ["Dante AV 4K-T Connectors"](#) on page 7 and ["Dante AV 4K-R Connectors"](#) on page 8 for locations of the IR In and IR Out jacks

NOTE: Resistors R536, R537, R538, and R539 are provided to accommodate IR receivers with different pinouts.

NOTE: As far as sending IR-over-IP is concerned, the Dante AV 4K-T and Dante AV 4K-R units are functionally interchangeable. How this is implemented in Dante Controller's Routing Tab is illustrated in the figure ["Routing Tab of Bidirectional IR-Over-IP using Dante AV 4K-T and Dante AV 4K-R"](#) on page 37 below.

IR-Over-IP: Dante Controller Routing

The example routing tab screen capture below shows that you can connect the IR-Over-IP control flow in either direction between network attached Dante AV 4K-T and 4K-R units (even at the same time).

However in practice, typically one IR control direction would suffice; (such a handheld IR remote in a control room sending to a remotely located video projector or media player).

This means that you can connect IR-Over-IP using any convenient pair of AJA Dante AV 4K-T and 4K-R devices, including:

- Dante AV 4K-T IR transmit to Dante AV 4K-T IR receive
- Dante AV 4K-R IR transmit to Dante AV 4K-R IR receive
- Dante AV 4K-T IR transmit to Dante AV 4K-R IR receive
- Dante AV 4K-R IR transmit to Dante AV 4K-T IR receive

The IR control routing possibilities for just one Dante AV 4K-T and one Dante AV 4K-R unit are shown below.

Figure 29. Routing Tab of Bidirectional IR-Over-IP using Dante AV 4K-T and Dante AV 4K-R

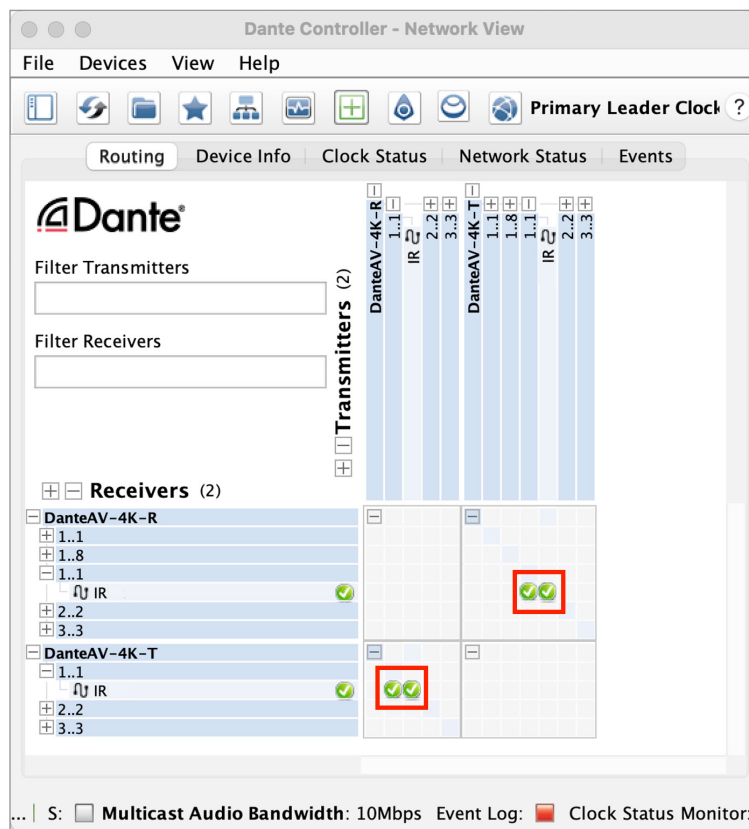

CAUTION: Suitability for a particular Dante Controller routing configuration depends upon the types of IR devices being connected and their respective IR protocols.

Serial Control over IP

Advantages of Serial Control Over IP

Serial over IP can be used with:

- PTZ joystick controller
- PTZ camera
- Other devices.

Implementing Serial Control Over IP

Serial Control Specifications

- RS-422 compatible with
- Visca Control for PTZ camera

Serial-Over-IP: Example PTZ Camera Setups

Figure 30. Serial-over-IP through a Dante AV 4K-T and 4K-R to PTZ Camera from a Joystick Controller

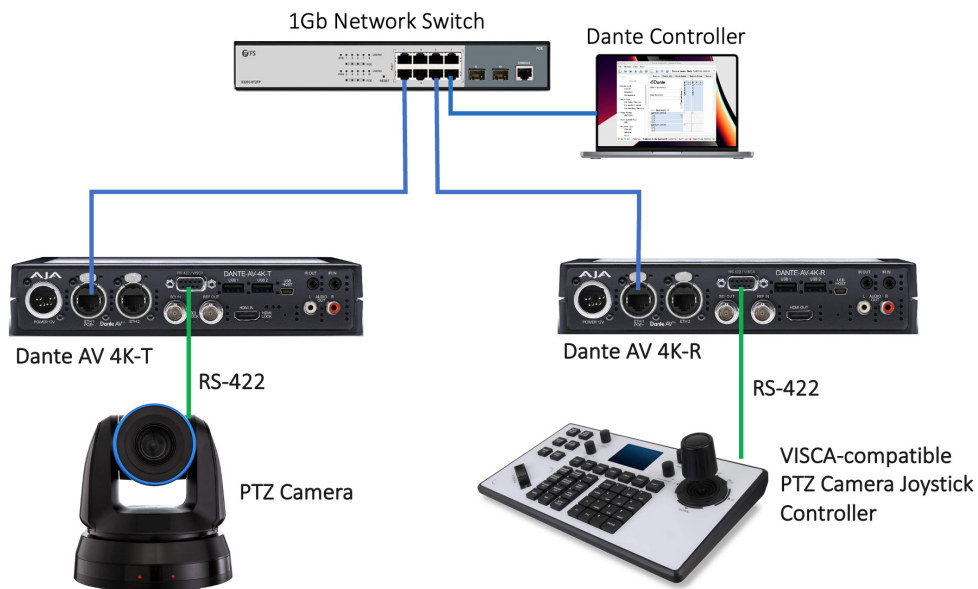

NOTE: See ["Dante AV 4K-T Connectors"](#) on page 7 and ["Dante AV 4K-R Connectors"](#) on page 8 for locations of the Serial (RS-422) port

NOTE: As far as sending Serial-over-IP is concerned, the Dante AV 4K-T and Dante AV 4K-R units are functionally interchangeable (depending upon the types of serial devices used.) We show this in the figure ["Routing Tab of Serial-Over-IP using Dante AV 4K-T and Dante AV 4K-R"](#) on page 39 below.

Serial-Over-IP: Dante Controller Routing

The example Routing Screen capture below shows that you can connect the Serial-Over-IP control flow in either direction between network attached Dante AV 4K-T and 4K-R units (even at the same time).

However in practice, typically one Serial control direction would suffice. This means that you can route Serial-Over-IP transmit and receive channel connections using any convenient pair of AJA Dante AV 4K-T and 4K-R devices, including:

- Dante AV 4K-T Serial transmit to Dante AV 4K-T Serial receive
- Dante AV 4K-R Serial transmit to Dante AV 4K-R Serial receive
- Dante AV 4K-T Serial transmit to Dante AV 4K-R Serial receive
- Dante AV 4K-R Serial transmit to Dante AV 4K-T Serial receive

The Serial Control routing possibilities for just one Dante AV 4K-T and one Dante AV 4K-R unit are shown below.

Figure 31. Routing Tab of Serial-Over-IP using Dante AV 4K-T and Dante AV 4K-R

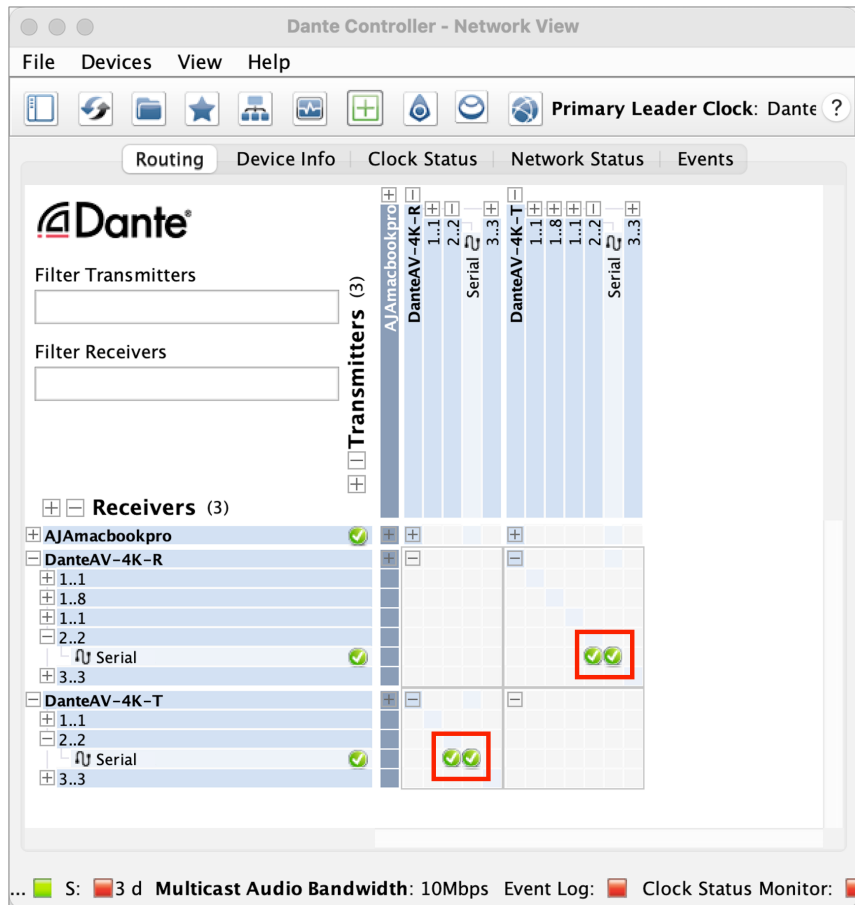

CAUTION: Suitability for a particular Dante Controller routing configuration depends upon the types of serial devices being connected and their respective serial protocols.

USB over IP

Advantages of USB Over IP

KVM

The entire Dante network can function like a gigantic KVM switch for connected USB keyboards and mice. One keyboard and mouse could remotely control as many computers as are connected to Dante-AV 4K-T and 4K-R devices on the network. USB On The Go (OTG) for keyboard and mouse.

Implementing USB Over IP

USB 1 & 2 Specifications

- USB Type-A connector, female
- Available Power: 100 mA at 5 VDC

USB Over IP: Setups for KVM

Figure 32. USB-over-IP using Dante AV 4K-T and 4K-R: controlling a computer through a Dante AV 4K-T unit

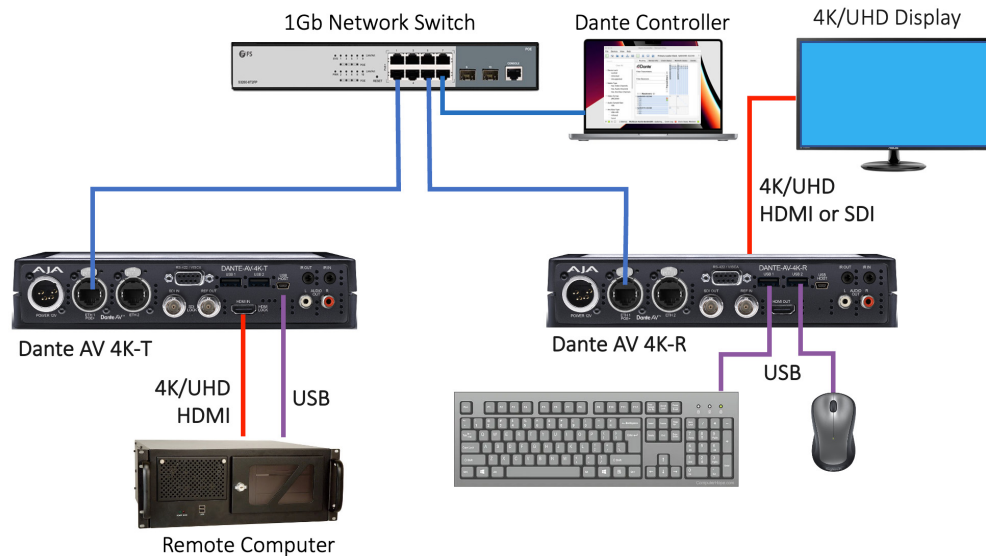

NOTE: See ["Dante AV 4K-T Connectors"](#) on page 7 and ["Dante AV 4K-R Connectors"](#) on page 8 for locations of the USB 1 and USB 2 ports.

NOTE: As far as sending USB-over-IP is concerned, the Dante AV 4K-T and Dante AV 4K-R units are functionally interchangeable (depending upon the types of USB devices used). We illustrate this in the figure ["Routing Tab of bidirectional USB Over-IP using Dante AV 4K-T and 4K-R"](#) on page 41 below.

USB-Over-IP: Dante Controller Routing

The example routing tab screen capture below shows that you can route the USB-Over-IP channel connections in either direction between network attached Dante AV 4K-T and 4K-R units (even at the same time). However in practice, typically one USB control direction would suffice.

This means that you can connect Serial-Over-IP transmit and receive connections using any convenient pair of AJA Dante AV 4K-T and 4K-R devices, including:

- Dante AV 4K-T USB transmit to Dante AV 4K-T USB receive
- Dante AV 4K-R USB transmit to Dante AV 4K-R USB receive
- Dante AV 4K-T USB transmit to Dante AV 4K-R USB receive
- Dante AV 4K-R USB transmit to Dante AV 4K-T USB receive

The USB routing possibilities for just one Dante AV 4K-T and one Dante AV 4K-R unit are shown below.

Figure 33. Routing Tab of bidirectional USB Over-IP using Dante AV 4K-T and 4K-R

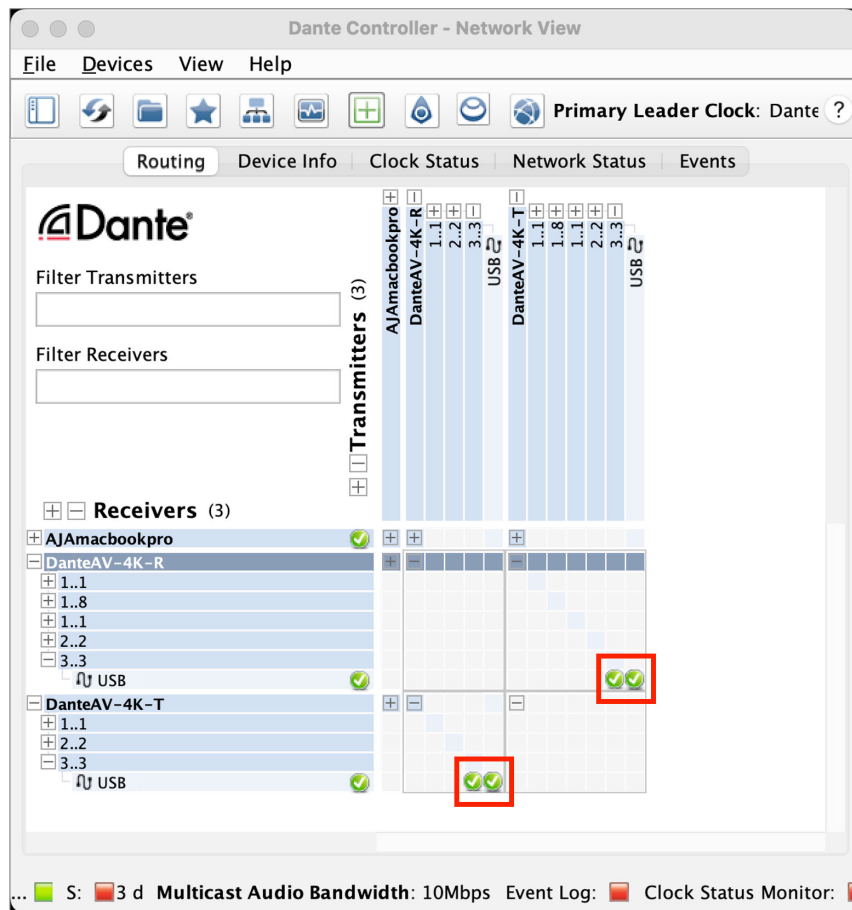

CAUTION: Suitability for a particular Dante Controller routing configuration depends upon the types of USB devices being connected and their respective USB protocols.

User Presets

Dante Controller supports the saving and loading of Dante network routing and device configurations, known as 'presets'. A preset file contains configuration and routing parameters for some or all of the devices in the network.

Preset files are saved as XML, and can be edited offline. They are also 'device-agnostic' - they can be shared between networks with different physical devices.

What can I do with Presets?

- Backup and restore network configurations
- Quickly switch between saved network configurations
- Copy a Dante network configuration from a 'lab' or test network to a live or production network
- Create network configurations for special, or periodic events, and then switch back to the standard configuration when desired
- Quickly apply one or more configuration settings to a number of devices simultaneously - for example, setting all devices on your network to the same sample rate (global configuration)
- Use Dante Controller as an off-line editing tool – off-line edit the saved preset configuration for reuse in new network configuration deployments

When are Presets Helpful?

Dante Controller's Preset feature becomes indispensable when:

- You have a large Dante network with many Dante devices
- You use many audio channels and use customized channel names
- You used many audio channels even with few devices
- You use several Multicast and Flow setups
- The venue has different "modes" of operation, as to which types of activities and media are running in different rooms, or how channels are named and managed
- You sometimes vary the control directions or where the connected equipment is attached, in your routing of IR-, Serial-, and USB- over-IP devices.

Device Roles

Presets introduce the concept of 'device roles'. When a preset is saved, the configuration and routing for each selected device is saved into the preset as a device role, with the same name as the device from which it was created.

If a role is applied to a device that is different from the role's originating device - for example, a role for console model A is applied to console model B - Dante Controller will identify any issues that might arise (such as unsupported sample rates) and will display those issues so they can be addressed - or ignored, if they are not important.

Saving Presets

Figure 34. Example of Saving a Preset

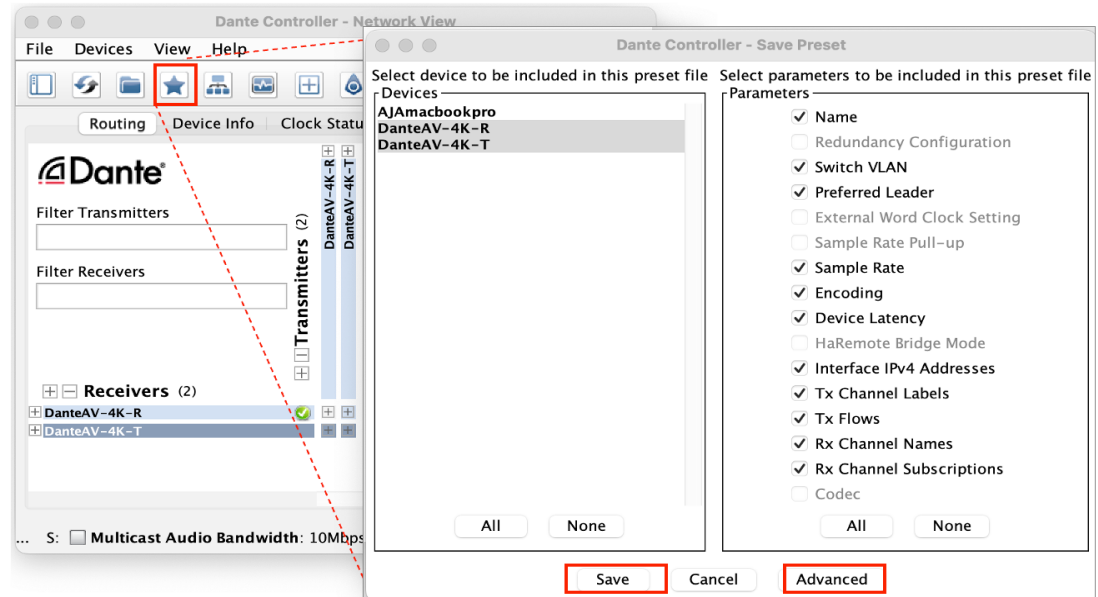

To save a Preset that includes all device parameters:

1. Click the 'Save Preset' button (the star icon) in the Network View main toolbar:
2. Select the devices that you wish to include in the preset. Click All to select all devices, or None to clear all selections.
3. Click Save.

Or, to save a Preset that also includes a selection of device parameters:

1. Click the 'Save Preset' button in the Network View main toolbar.
2. Click Advanced.
3. Select the devices that you wish to include in the preset.
4. Select the parameters that you want to save for the selected devices.
5. Click Save; the final Save dialog (not shown) let's you set a Preset name; click Save.

NOTE: Presets are saved as an xml files, which can be manually edited if required, using a text editor.

Applying Presets

To load and apply a saved preset,

1. Select File > Load Preset from the main menu (Ctrl + L).
2. Select the Preset you want.
3. Click Open. (Note that legacy preset files are supported.)

Figure 35. Select a Preset to Load

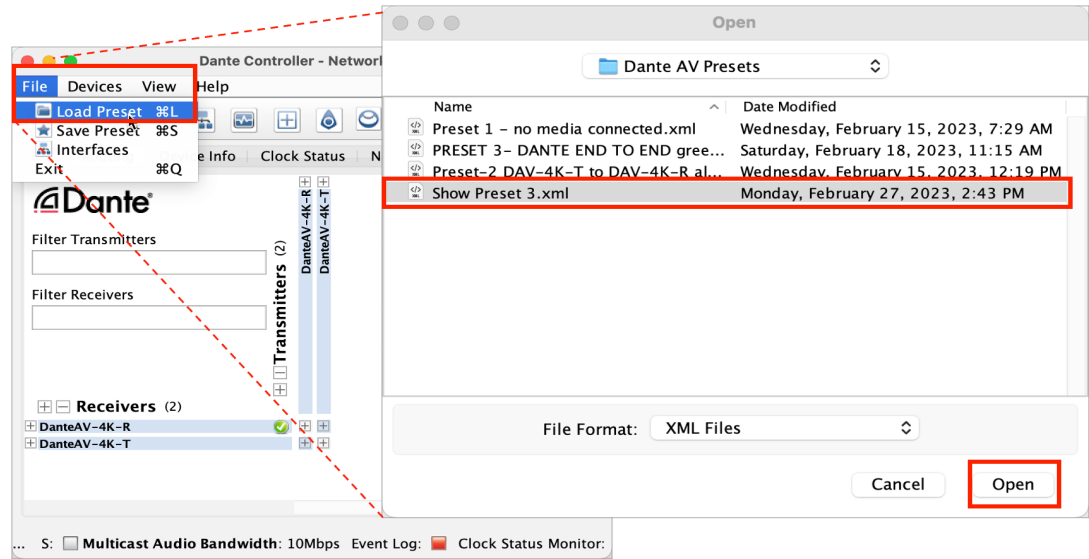

The 'Apply Preset' dialog window which opens, is arranged in 4 columns, representing the logical steps in applying a preset (from left to right).

Figure 36. Apply Preset Dialog

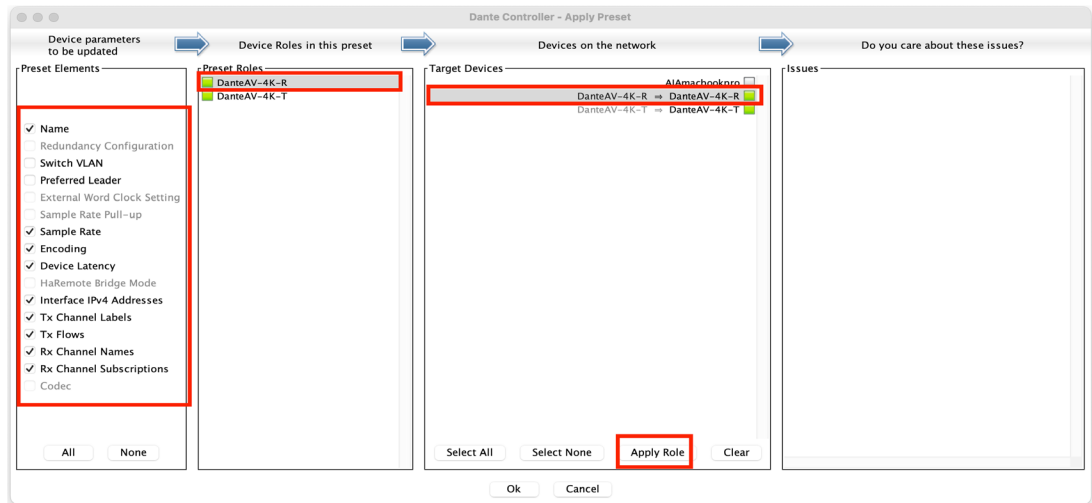

4. Check the device parameters you wish to include.
5. Chose the Device Role desired in the second column.
6. Choose the Target Device(s) in the Third Column.
7. Respond to the issues presented in the fourth column (if any).
8. Clip Apply Role.
9. Click OK.
10. Wait until the applying preset progress bar completes all the way to 100%.
11. Click OK.

Figure 37. Configure and Enable a Preset

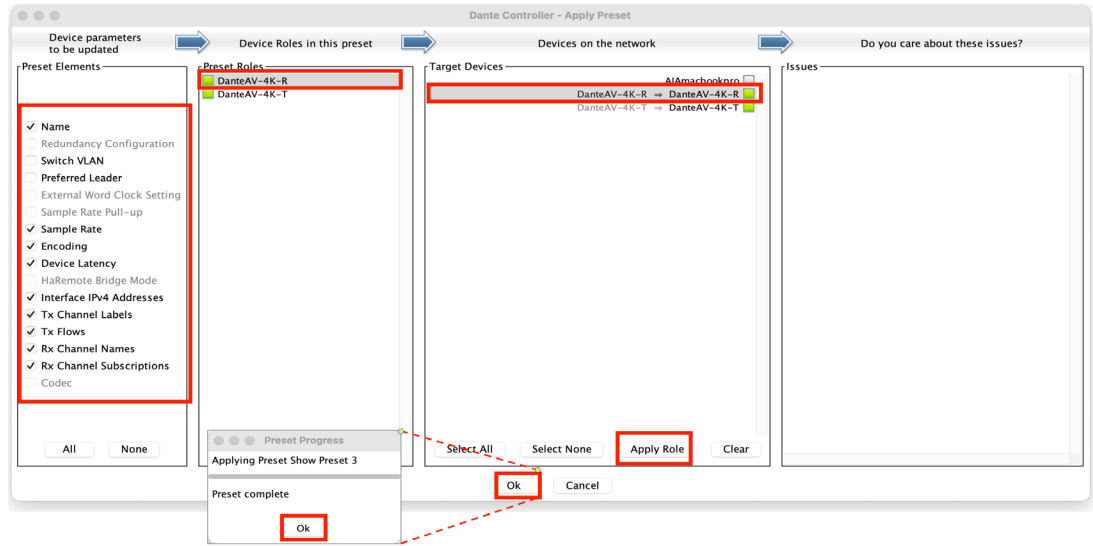

NOTE: See the **Presets** section of [Audinate's Dante Controller User Guide](#) for additional information.

Chapter 4 – Interoperability

Dante Applications for PC or Mac

A number of software applications from [Audinate](#) are used to work with the [Dante ecosystem](#), and which may run on either PC or Mac computers.

Dante Controller

[Dante Controller](#) shows the Dante AV 4K-T and 4K-R devices as 8 routable audio sources and 8 routable audio destinations, as well as 1 routable video source and 1 routable video destination. Use this application to set up the audio and video routing between Dante devices, control the audio and video connections in the Dante setup, and move audio and video in real-time over an Ethernet network.

See "[Available Dante Video Training by Audinate](#)" on page 52.

Dante Via

If you have an computer DAW workstation or any computer with audio applications that you would like to route to and from Dante AV 4K-T and 4K-R units, simply install the [Dante Via](#) on the DAW computer.

No special Dante hardware is required. Use [Dante Via](#) to configure audio devices to appear on the Dante network; for example, making the stereo audio portion of U-TAP appear as two audio source channels on the Dante network.

Dante Virtual Soundcard

[Dante Virtual Soundcard](#) integrates a Windows or MacOS computer into a Dante-powered audio workstation. It connects with the Dante network to record, process and playout up to 64 bidirectional channels of lossless audio, using any audio application and any combination of Dante-enabled devices.

Supports 16, 24 and 32-bit audio. Up to 64x64 audio channels @ 44.1/48kHz (up to 32x32 @ 88.2/96kHz, or up to 8x8 @ 176.4/192 kHz).

Dante Virtual Soundcard appears as a standard ASIO or WDM Sound device on Windows, and as a Core Audio sound device on macOS. No additional hardware or software is required.

Third Party Software Applications

Many third-party software applications exist that contain built-in Dante connectivity to networked audio devices and programs. This means that each application has its own unique connections to Dante devices and can process audio independently on a single computer. Applications may perform any number of audio tasks, from recording to signal processing to visualization.

Consideration of these Third-Party Applications is beyond the scope of this manual, but there is plenty of available information online.

NOTE: [Please see "Third Party Applications" on the Audinate website for information.](#)

Chapter 5 – Troubleshooting

Troubleshoot Using the Dante AV 4K-T and 4K-R LEDs

The Dante AV 4K-T and 4K-R units include a generous set of color LED status indicators on both the front and rear of the units. For status LED locations and their respective behaviors, refer to "[LED Indicators](#)" on page 9 in this manual.

Troubleshoot Using the Dante Controller Application

Automatic Notification of Device Errors

Dante Controller is able to identify several types of problems that a Dante device may experience. A device that is found to have problems will have its device name displayed in red. Additional information about the problem can be found by double-clicking on the device.

A device displayed in **red** will either have entered failsafe mode, or will have an identified issue with its IP configuration. These states are described in more detail below.

A device displayed in **orange** ('Ultimo' low channel count devices only) will have entered upgrade mode (see below).

Additional helpful information includes:

- Incorrect IP address configuration
- Failsafe Mode
- Upgrade Mode
- Other Event Notifications '

See the **Automatic Notification of Device Errors** section of [Audinate's Dante Controller User Guide](#) for additional information.

On-Screen Warning and Error Indicators

The Dante Controller application provides warnings or error indicators in the User Interface for the following conditions. These can be extremely helpful in pinpointing problems or issues. Below we show one example.

Error with Signal Connection Indicators.

Blocked Icon(s) appears instead of a green check mark(s), when making Connections in the Routing Tab, and in the Device View's Receive/Transmit tabs.

This is from two potential causes: if video, then either a signal that requires multicasting to add the connection to, or source video for the connection isn't actually connected to the 4K-T unit. If audio, it would be only the latter.

Figure 38. Video Signal Blocked in Receive Tab of Device View

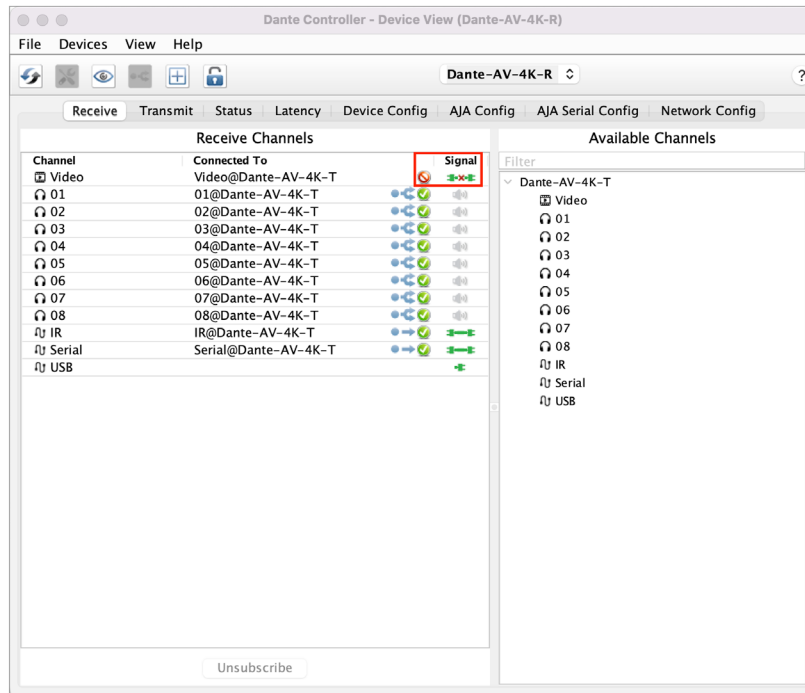

Error Messages on Startup

Device Subscription warnings or errors

Event Classification Errors including

- Invalid link local address
- Subnet mismatch on Dante interface
- Subnet match with non Dante interface
- Multiple addresses with matching subnets
- Subnet conflict of Dante interface on primary
- Subnet conflict of Dante interface on secondary
- Unknown address error
- Fail Safe Mode
- Unknown device issue
- Elevation to Clock Leader
- Fanout Configuration detected
- Mismatched clock pullup subdomain
- Wrong subdomain for pullup
- Unknown subdomain
- Audio mute / Audio unmute
- Clock sync lock / unlocked

Event Classification Warnings

- Resolution Failed
- Elevation to Primary Leader
- Multiple external clock sources
- Cannot Elevate to Clock Leader
- Clock Sync Warning

Latency Errors

- Green, Amber or red on-screen "LEDs"

Packet Errors

- Red on-screen "LED"

Primary Interface Errors

- CRC check or packet errors

Status Bar Indicators:

- On-screen red or green "LEDs"
- Status of Primary Network
- Status of Secondary Network
- Event Log Status
- Clock Status Monitor

Receive Tab

- Colored Status Icons

Transmit Tab

- Colored Status Icons

Computer Configuration

Before installing Dante Controller, you must be logged in to your computer as a user with administrator privileges.

To be correctly configured for use with a Dante network, the computer should have:

- Dante Controller installed
- The correct network interface/s selected
- The correct IP addresses in use
- Firewall configuration; third-party firewalls will need to be manually configured.

Network Configuration

Although the automatic configuration and discovery features of the Dante AV 4K-T and Dante AV 4K-R devices are extremely powerful and robust, they nonetheless need to be connected to a network with appropriate ethernet cabling, routers and switches. Having a correct IP configuration on the host computer is also important.

Troubleshooting Dante IP Address Configuration

All devices in a Dante network, including Dante Virtual Soundcard, must be using IP addresses from the same network. When using Dante Virtual Soundcard or Dante Controller, your PC or Mac must be connected to the Primary and/or Secondary Dante network, and must have a correct IP address.

NOTE: If a device name is shown in red, it means Dante Controller has automatically detected an error condition, such as an IP address configuration issue, or the device has entered failsafe. Double-click the red device name to see more information.

Correct IP configuration

Dante AV 4K-T and 4K-R devices are set to obtain their IP address automatically from the network. They will either:

- Automatically assign themselves an address in the range 169.254.*.* (172.31.*.* for the secondary network if present), or
- Obtain an IP address from a DHCP server if it is present on the network

Your PC or Mac TCP/IP network configuration set should be set to 'Obtain an IP address automatically'. This way it will automatically acquire a Link Local automatic IP address in the same network as other Dante devices. If a DHCP server is present, the computer and Dante devices will all acquire their IP addresses via DHCP.

IP Network Configuration: Possible Mistakes

Possible network configuration errors are listed below. Dante Controller will try to automatically detect these. If detected the offending device will be displayed in red.

Incorrect PC/Mac IP Configuration

- Accidentally having multiple network interfaces with addresses in the same subnet
- If your secondary network is using Link Local (no DHCP server), all devices on that network will be in the 172.31.*.* range. The secondary network interface for the computer must be manually configured (using static IP addressing) to the same range.

Incorrect General IP Configuration

- Accidentally having multiple DHCP servers on the same network
 - Unusual – for example, someone may have a PC connected to the network with a DHCP server running that they're not aware of.
- Incorrectly configured static IP addresses
 - You shouldn't typically need to configure static IP addresses at all. If for some reason you do, it must be in the same subnet as the rest of the network.

What are the symptoms of using the wrong network interface on my computer?

If you have more than one wired network interface, and Dante Controller is not using the interface the rest of the Dante devices are connected to:

- Dante Controller cannot see any Dante devices
- Dante Virtual Soundcard is not sending or receiving any audio when it is expected to

How do I check which network interfaces Dante Controller is using?

- The selected network interfaces can be viewed or changed via the 'interface selection' button in the Network View toolbar of Dante Controller.

Figure 39. Configure Dante Interfaces in the unmanaged mode

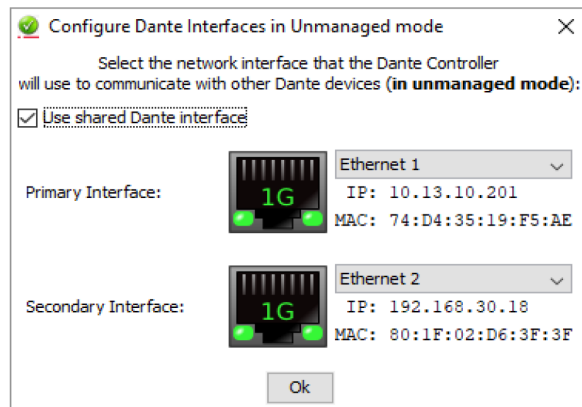

- If the Dante network is standalone and does not have a DHCP server installed, the addresses should be in the range 169.254.*.*
- If the Dante network is using a DHCP server, the IP addresses should conform to the addressing scheme it is using (as shown in the image above)

How do I check IP addresses for all devices on my network?

- Use the Device Info tab to view the IP addresses of all the devices on your network.

Figure 40. Checking Primary Address

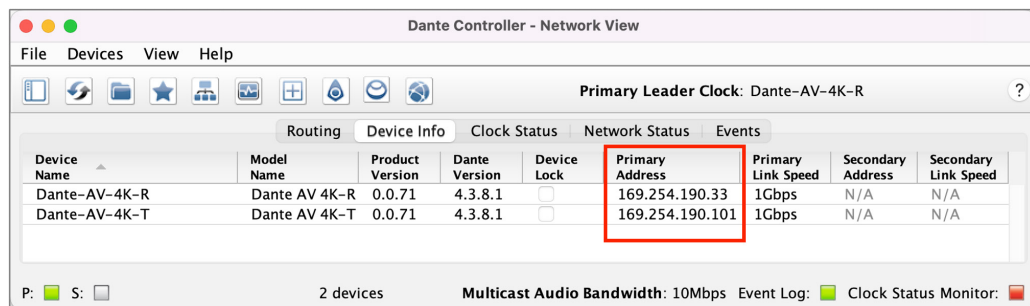

- The Primary Address of all devices should follow the same IP address scheme (e.g. 169.254.*.* or 10.12.0.*). Same for secondary addresses.
- Note that some older Dante devices or devices running older firmware may not show this information.

Troubleshooting Switch Configuration and Cabling

Cables are the most vulnerable part of a network system. If you suspect cabling issues, check for:

- Faulty or manually terminated cables
- Unplugged /badly connected Ethernet cables
- Incorrectly configured switches
- Dante devices removed or turned off

Symptoms of Switch or Cabling Issues

- You cannot see (some) devices in the Dante Controller network view
- Dante Controller shows orange “unsuccessful subscription” icons, which usually means a device that was present earlier is now missing
- Faulty cables can lead to intermittent faults, which may be heard as dropped samples or “cracks” in the audio
- Dante devices may appear and disappear in Dante Controller

Switch Checklist

- Is the switch IEEE compliant? It may have known Dante network compatibility issues.

NOTE: See [Can I Use IEEE Switches in my Dante Network?](#)

- Are all the connected link/status lights on the switch lit, or flashing as expected?
 - Is the switch powered on?
 - Is the cable correctly plugged in at the switch and the PC or equipment?
 - Is the switch correctly configured?
 - Perhaps QoS or VLANs have been incorrectly set up?
- Are you using a switch from another application with an unchecked or tested configuration?
 - Consult the switch manual and check the switch configuration

NOTE: Video (Dante AV) devices including the AJA Dante AV 4K-T and Dante AV 4K-R require at least GigE ports and cables.

Available Dante Video Training by Audinate

Audinate offers comprehensive training videos that cover the extensive capabilities of the Dante Controller.

The video series "Getting Started with Dante" provides a high-level overview of Dante audio networking. Please refer to these videos to learn how to setup and use a Dante system:

<https://www.audinate.com/learning/training-certification/video-tutorials/video-series-getting-started-with-dante-audio-networking-training>

In addition, Audinate offers another video series, "Dante Controller 101," that goes over the essential functions and features of Dante Controller:

<https://www.audinate.com/learning/training-certification/video-tutorials/video-series-dante-controller-101>

Appendix A – Specifications

Dante AV 4K Tech Specs

Video Formats

- (4K) 4096 x 2160p
- (UltraHD) 3840 x 2160p
- (2K) 2048 x 1080p
- (HD) 1920 x 1080p
- (HD) 1280 x 720p

VESA Formats:

- (WUXGA) 1920x1200
- (UXGA) 1600x1200
- (SXGA) 1280x1024
- (XGA) 1024x768
- (SVGA) 800x600
- (VGA) 640x480

NOTE: VESA Formats are always RGB 4:4:4 60 8-bit

Discovery, Registration and Control

- Dante Controller Software from Audinate (Windows or Mac)
- Dante Ecosystem Friendly: Compatible with existing Dante-enabled products

Media Transport Interfaces

Network Interface: Standard 1 GigE Ethernet.

Audio Flow: Audio Flow x 8 Flows / 8-channels per Flow (unicast or multicast)

Video Flow: Video Flow x 1 Flow / 1-channel per Flow (unicast or multicast)

Timestamp: Hardware timestamping, supporting sample accurate playback

Video Input Digital (4K-T)

- 1x 12G-SDI BNC, SMPTE 292 (1.5Gb/s), 424, 425-A(3Gb/s), 2081, 2082, 352 SDI Metadata Supported
 - YCbCr 4:2:2
 - 10-bit
 - Two Sample Interleave (2SI) 4K/UltraHD source mapping
- 1x 12G SDI
 - (4K) 4096 x 2160p 50, 59.94, 60
 - (UltraHD) 3840 x 2160p 50, 59.94, 60
- 1x 6G SDI
 - (4K) 4096 x 2160p 23.98, 24, 25, 29.97, 30
 - (UltraHD) 3840 x 2160p 23.98, 24, 25, 29.97, 30
- 1x 3G-SDI (Level A)
 - (2K) 2048 x 1080p 50, 59.94, 60
 - (HD) 1920 x 1080p 50, 59.94, 60
 - (HD) 1280 x 720p 50, 59.94, 60
- 1x 1.5G-SDI
 - (2K) 2048 x 1080p 23.98, 24, 25, 29.97, 30

- (HD) 1920 x 1080p 23.98, 24, 25, 29.97, 30
- (HD) 1920 x 1080PsF 23.98, 24, 25, 29.97, 30
- (HD) 1280 x 720p 50, 59.94, 60
- 1x HDMI Type A connector, HDMI v2.0
 - YCbCr 4:4:4, 4:2:2
 - RGB 4:4:4, SMPTE or Full RGB.
 - 8, 10, 12-bit (4K/UltraHD 4:4:4 limited to 8-bit)
 - (4K) 4096 x 2160p 23.98, 24, 25, 29.97, 30, 50, 59.94, 60
 - (UltraHD) 3840 x 2160p 23.98, 24, 25, 29.97, 30, 50, 59.94, 60
 - (2K) 2048 x 1080p 23.98, 24, 25, 29.97, 30, 50, 59.94, 60
 - (HD) 1920 x 1080p 23.98, 24, 25, 29.97, 30, 50, 59.94, 60
 - (HD) 1280 x 720p 50, 59.94, 60
- (WUXGA) 1920x1200*
- (UXGA) 1600x1200*
- (SXGA) 1280x1024*
- (XGA) 1024x768*
- (SVGA) 800x600*
- (VGA) 640x480*

Note: VESA Formats are always RGB 4:4:4 60 8-bit

Video Output Digital (4K-R)

- 1x 12G-SDI BNC, SMPTE 292 (1.5Gb/s), 424, 425-A(3Gb/s), 2081, 2082, 352 SDI Metadata Supported
 - YCbCr 4:2:2
 - 10-bit
 - Two Sample Interleave (2SI) 4K/UltraHD source mapping
- 1x 12G SDI
 - (4K) 4096x2160p 50, 59.94, 60
 - (UltraHD) 3840x2160p 50, 59.94, 60
- 1x 6G SDI
 - (4K) 4096x2160p 23.98, 24, 25, 29.97, 30
 - (UltraHD) 3840x2160p 23.98, 24, 25, 29.97, 30
- 1x 3G-SDI (Level A)
 - (HD) 1920x1080p 50, 59.94, 60
 - (HD) 1280x720p 50, 59.94, 60
- 1x 1.5G-SDI
 - (HD) 1920x1080p 23.98, 24, 25, 29.97, 30
 - (HD) 1280x720p 50, 59.94, 60
- 1x HDMI Type A connector, HDMI v2.0*
 - YCbCr 4:4:4, 4:2:2, SMPTE, or Full RGB
 - 8, 10, 12-bit (4K/UltraHD 4:4:4 limited to 8-bit)
 - (4K) 4096x2160p 23.98, 24, 25, 29.97, 30, 50, 59.94, 60
 - (UltraHD) 3840x2160p 23.98, 24, 25, 29.97, 30, 50, 59.94, 60
 - (HD) 1920x1080p 23.98, 24, 25, 29.97, 30, 50, 59.94, 60
 - (HD) 1280x720p 50, 59.94, 60
- (WUXGA) 1920x1200
- (UXGA) 1600x1200
- (SXGA) 1280x1024
- (XGA) 1024x768
- (SVGA) 800x600
- (VGA) 640x480

Notes:

1. VESA Formats are always RGB 4:4:4 60 8-bit.
2. Only one input can be used at a time. Unit will auto-detect source, or user can select input in software if both SDI & HDMI inputs are connected.

*If a connected monitor doesn't support HDMI protocol, the unit automatically switches to DVI protocol (which does not pass audio).

Audio Input Digital (4K-T) & Audio Output Digital (4K-R)

- SDI embedded audio, 24-bit, 8-channel, 48 kHz PCM24
- HDMI embedded audio, 24-bit, 8-channel, 48 kHz PCM24

Audio Output Analog

- 2x RCA analog audio
 - Levels at -10 dBu (nominal)

IP Video Input (4K-R) & IP Video Output (4K-T)

- Dante AV Ultra
 - Single video channel

IP Audio Input (4K-R) & IP Audio Output (4K-T)

- Dante Audio
 - Up to 8-channel audio, 24-bit per channel, 48 kHz PCM24
 - High quality, low jitter with onboard clock generator for audio
 - SRC Conversion Range: 1:8 to 8:1
 - ASRC Latency: 80 samples (1.6ms 48 kHz)

Reference

- 1x BNC
 - (4K-T) Reference Out connector (For future use)
 - (4K-R) Reference Input connector (For future use)

Codec

- Video Codec: Optimized implementation of JPEG 2000 codec in FPGA, Licensed By IntoPIX; Dante API management interface
- Video Resolutions & Color Depth:
 - SDI: Up to 4096x2160@60Hz; YCbCr 4:2:2 @ 10-bit
 - HDMI: Up to 4096x2160@60Hz; RGB 4:4:4 @ 8-bit YCbCr 4:4:4 @ 8-bit YCbCr 4:2:2 @8/10/12-bit
- Audio Formats: Dante Audio over IP
- Bit Rates up to 700 Mbps
- Video Streaming: Unicast or Multicast
- Copy Protection: HDCP 2.2, HDCP 2.3 for network.
- Latency: 0.5 frame (e.g. 2160p @ 60 Hz latency is < 8 ms between encoder and decoder)
- Bandwidth 1: 4Kp60 10-bit 4:2:2; 500-600Mbps, results may vary depending on network configuration and management settings
- Bandwidth 2: 1080p60 10-bit 4:2:2; 150-250Mbps, results may vary depending on network configuration and management settings

Hardware Interface

- 1x Neutrik etherCon RJ45 Connector – 1 GigE (Dante AV & POE+)
- 1x Neutrik etherCon RJ45 Connector – 1 GigE (for future use)
- 1x DB-9 RS-422/ VISCA Serial Port
- 2x USB 2.0 Type A Connector
- 1x USB 2.0 Mini-B Host connector
- 3.5mm IR Tx jack for IR over IP
- 3.5mm IR Rx jack for IR over IP
- Front LED Indicators: Power, Codec, System, Status, Sync, & HDCP

Size (W x D x H)

- 8.74" x 7.09" x 1.65" (222.0 x 180.09 x 41.91 mm).

Weight

- 3.1 lbs. (1.5 kg).

Power

- Input: 1.5 A maximum @ 100-240 VAC, 50/60 Hz, Output: 4A @ 12 VDC; 12V DC IN has priority over Ethernet 1 POE. Ethernet 1 POE will become active a fraction of a second after 12V DC IN is disconnected

Environment

- Safe Operating Temperature: 0 to 40 C (32 to 104 F)
- Safe Storage Temperature (Power OFF): -40 to 60 C (-40 to 140 F)
- Operating Relative Humidity: 10-90% non condensing
- Operating Altitude: <3,000 meters (<10,000 feet).

Appendix B – Safety and Compliance

Federal Communications Commission (FCC) Compliance Notices

Class A Interference Statement

This equipment has been tested and found to comply with the limits for a Class A digital device, pursuant to Part 15, Subpart B of the FCC Rules. These limits are designed to provide reasonable protection against harmful interference in a residential installation. This equipment generates, uses, and can radiate radio frequency energy and, if not installed and used in accordance with the instructions, may cause harmful interference to radio communications. However, there is no guarantee that interference will not occur in a particular installation. If this equipment does cause harmful interference to radio or television reception, which can be determined by turning the equipment off and on, the user is encouraged to try to correct the interference by one or more of the following measures:

- Reorient or relocate the receiving antenna.
- Increase the separation between the equipment and receiver.
- Connect the equipment into an outlet on a circuit different from that to which the receiver is connected.
- Consult the dealer or an experienced radio/TV technician for help.

FCC Caution

This device complies with Part 15 of the FCC Rules. Operation is subject to the following two conditions: (1) This device may not cause harmful interference, and (2) this device must accept any interference received, including interference that may cause undesired operation.

Canadian ICES Statement

Canadian Department of Communications Radio Interference Regulations

This digital apparatus does not exceed the Class A limits for radio-noise emissions from a digital apparatus as set out in the Radio Interference Regulations of the Canadian Department of Communications. This Class A digital apparatus complies with Canadian ICES-003.

Règlement sur le brouillage radioélectrique du ministère des Communications

Cet appareil numérique respecte les limites de bruits radioélectriques visant les appareils numériques de classe A prescrites dans le Règlement sur le brouillage radioélectrique du ministère des Communications du Canada. Cet appareil numérique de la Classe A est conforme à la norme NMB-003 du Canada.

European Union and European Free Trade Association (EFTA) Regulatory Compliance

This equipment may be operated in the countries that comprise the member countries of the European Union and the European Free Trade Association. These countries, listed in the following paragraph, are referred to as The European Community throughout this document:

AUSTRIA, BELGIUM, BULGARIA, CYPRUS, CZECH REPUBLIC, DENMARK, ESTONIA, FINLAND, FRANCE, GERMANY, GREECE, HUNGARY, IRELAND, ITALY, LATVIA, LITHUANIA, LUXEMBOURG, MALTA, NETHERLANDS, POLAND, PORTUGAL, ROMANIA, SLOVAKIA, SLOVENIA, SPAIN, SWEDEN, UNITED KINGDOM, ICELAND, LICHTENSTEIN, NORWAY, SWITZERLAND

Declaration of Conformity

Marking by this symbol indicates compliance with the Essential Requirements of the EMC Directive of the European Union 2014/30/EU.



This equipment meets the following conformance standards:

Safety

EN 62368-1: 2014 + A11 (T-Mark License),
IEC 62368-1: 2014; (CB Scheme Certificate)

Additional licenses issued for specific countries available on request.

Emissions

EN 55032: 2015 + A11: 2020, CISPR 32: 2015, EN 61000-3-2: 2014, EN 61000-3-3: 2013

Immunity

EN 55035: 2017 + A11: 2020, EN 61000-4-2: 2009, EN 61000-4-3: 2006+ A1: 2008 + A2: 2010, EN 61000-4-4: 2012, EN 61000-4-5: 2014/A1: 2017, EN 61000-4-6: 2014, EN 61000-4-8: 2010, EN 61000-4-11: 2020

Environments: E2, E3 and E4

The product is also licensed for additional country specific standards as required for the International Marketplace



Warning! This is a Class A product. In a domestic environment, this product may cause radio interference, in which case, the user may be required to take appropriate measures.

Achtung! Dieses ist ein Gerät der Funkstörgrenzwertklasse A. In Wohnbereichen können bei Betrieb dieses Gerätes Rundfunkstörungen auftreten, in welchen Fällen der Benutzer für entsprechende Gegenmaßnahmen verantwortlich ist.

Attention! Ceci est un produit de Classe A. Dans un environnement domestique, ce produit risque de créer des interférences radioélectriques, il appartiendra alors à l'utilisateur de prendre les mesures spécifiques appropriées..

Recycling Notice



This symbol on the product or its packaging indicates that this product must not be disposed of with your other household waste. Instead, it is your responsibility to dispose of your waste equipment by handing it over to a designated collection point for the recycling of waste electrical and electronic equipment. The separate collection and recycling of your waste equipment at the time of disposal will help conserve natural resources and ensure that it is recycled in a manner that protects human health and the environment. For more information about where you can drop off your waste for recycling, please contact your local authority, or where you purchased your product.

Korea KCC Compliance Statement

사용자 안내문

이 기기는 업무용 환경에서 사용할 목적으로 적합성평가를 받은 기기로서 가정용 환경에서 사용하는 경우 전파간섭의 우려가 있습니다.

Taiwan Compliance Statement

警告使用者：
這是甲類的資訊產品，在居住的環境中使用時，可能會造成射頻干擾，在這種情況下，使用者會被要求採取某些適當的對策。

This is a Class A product based on the standard of the Bureau of Standards, Metrology and Inspection (BSMI) CNS 13438, Class A. In a domestic environment this product may cause radio interference in which case the user may be required to take adequate measures.

Japanese Compliance Statement

この装置は、クラスA情報技術装置です。この装置を家庭環境で使用すると電波妨害を引き起こすことがあります。この場合には使用者が適切な対策を講ずるよう要求されることがあります。 VCCI-A

This is a Class A product based on the standard of the VCCI Council (VCCI 32: 2016). If this equipment is used in a domestic environment, radio interference may occur, in which case, the user may be required to take corrective actions.

Translated Warning and Caution Messages

The following caution statements, warning conventions, and warning messages apply to this product and manual.



Warning Symbol



Hazard Symbol



Caution Symbol

Before Operation Please Read These Instructions



Warning! Read and follow all warning notices and instructions marked on the product or included in the documentation.

Avertissement! Lisez et conformez-vous à tous les avis et instructions d'avertissement indiqués sur le produit ou dans la documentation.

Warnung! Lesen und befolgen Sie die Warnhinweise und Anweisungen, die auf dem Produkt angebracht oder in der Dokumentation enthalten sind.

¡Advertencia! Lea y siga todas las instrucciones y advertencias marcadas en el producto o incluidas en la documentación.

Aviso! Leia e siga todos os avisos e instruções assinalados no produto ou incluídos na documentação.

Avviso! Leggere e seguire tutti gli avvisi e le istruzioni presenti sul prodotto o inclusi nella documentazione.



Warning! Do not use this device near water and clean only with a dry cloth.

Avertissement! N'utilisez pas cet appareil près de l'eau et nettoyez-le seulement avec un tissu sec.

Warnung! Das Gerät nicht in der Nähe von Wasser verwenden und nur mit einem trockenen Tuch säubern.

¡Advertencia! No utilice este dispositivo cerca del agua y límpielo solamente con un paño seco.

Aviso! Não utilize este dispositivo perto da água e limpe-o somente com um pano seco.

Avviso! Non utilizzare questo dispositivo vicino all'acqua e pulirlo soltanto con un panno asciutto.



Warning! Do not block any ventilation openings. Install in accordance with the manufacturer's instructions.

Avertissement! Ne bloquez aucune ouverture de ventilation. Suivez les instructions du fabricant lors de l'installation.

Warnung! Die Lüftungsöffnungen dürfen nicht blockiert werden. Nur gemäß den Anweisungen des Herstellers installieren.

¡Advertencia! No bloquee ninguna de las aberturas de la ventilación. Instale de acuerdo con las instrucciones del fabricante.

Aviso! Não obstrua nenhuma das aberturas de ventilação. Instale de acordo com as instruções do fabricante.

Avviso! Non ostruire le aperture di ventilazione. Installare in conformità con le istruzioni del fornitore.



Warning! Do not install near any heat sources such as radiators, heat registers, stoves, or other apparatus (including amplifiers) that produce heat.

Avertissement! N'installez pas l'appareil près d'une source de chaleur telle que des radiateurs, des bouches d'air de chauffage, des fourneaux ou d'autres appareils (amplificateurs compris) qui produisent de la chaleur.

Warnung! Nicht in der Nähe von Wärmequellen wie Heizkörpern, Heizregistern, Öfen oder anderen Wärme erzeugenden Geräten (einschließlich Verstärkern) aufstellen.

¡Advertencia! No instale cerca de fuentes de calor tales como radiadores, registros de calor, estufas u otros aparatos (incluidos amplificadores) que generan calor.

Aviso! Não instale perto de nenhuma fonte de calor tal como radiadores, saídas de calor, fogões ou outros aparelhos (incluindo amplificadores) que produzam calor.

Avviso! Non installare vicino a fonti di calore come termosifoni, diffusori di aria calda, stufe o altri apparecchi (amplificatori compresi) che emettono calore



Warning! Refer all servicing to qualified service personnel. Servicing is required when the device has been damaged in any way, such as power-supply cord or plug is damaged, liquid has been spilled or objects have fallen into the device, the device has been exposed to rain or moisture, does not operate normally, or has been dropped.

Avertissement! Référez-vous au personnel de service qualifié pour tout entretien. L'entretien est exigé quand l'appareil a été endommagé de quelque manière que ce soit, par exemple lorsque le cordon d'alimentation ou la prise sont endommagés, que du liquide a été versé ou des objets sont tombés dans l'appareil, que l'appareil a été exposé à la pluie ou à l'humidité, ne fonctionne pas normalement ou est tombé.

Warnung! Das Gerät sollte nur von qualifizierten Fachkräften gewartet werden. Eine Wartung ist fällig, wenn das Gerät in irgendeiner Weise beschädigt wurde, wie bei beschädigtem Netzkabel oder Netzstecker, falls Flüssigkeiten oder Objekte in das Gerät gelangen, das Gerät Regen oder Feuchtigkeit ausgesetzt wurde, nicht ordnungsgemäß funktioniert oder fallen gelassen wurde.

¡Advertencia! Consulte al personal calificado por cuestiones de reparación. El servicio de reparación se requiere cuando el dispositivo ha recibido cualquier tipo de daño, por ejemplo cable o espigas dañadas, se ha derramado líquido o se han caído objetos dentro del dispositivo, el dispositivo ha sido expuesto a la lluvia o humedad, o no funciona de modo normal, o se ha caído.

Aviso! Remeta todos os serviços de manutenção para o pessoal de assistência qualificado. A prestação de serviços de manutenção é exigida quando o dispositivo foi danificado mediante qualquer forma, como um cabo de alimentação ou ficha que se encontra danificado/a, quando foi derramado líquido ou caíram objectos sobre o dispositivo, quando o dispositivo foi exposto à chuva ou à humidade, quando não funciona normalmente ou quando foi deixado cair.

Avviso! Fare riferimento al personale qualificato per tutti gli interventi di assistenza. L'assistenza è necessaria quando il dispositivo è stato danneggiato in qualche modo, ad esempio se il cavo di alimentazione o la spina sono danneggiati, è stato rovesciato del liquido è stato rovesciato o qualche oggetto è caduto nel dispositivo, il dispositivo è stato esposto a pioggia o umidità, non funziona correttamente o è caduto



Warning! Disconnect the external AC power supply line cord(s) from the mains power before moving the unit.

Avertissement! Retirez le ou les cordons d'alimentation en CA de la source d'alimentation principale lorsque vous déplacez l'appareil.

Warnung! Trennen Sie die Wechselstrom-Versorgungskabel vom Netzstrom, bevor Sie das Gerät verschieben.

¡Advertencia! Cuando mueva la unidad desenchufe de la red eléctrica el/los cable(s) de la fuente de alimentación CA tipo brick.

Advertência! Remova os cabos CA de alimentação brick da rede elétrica ao mover a unidade.

Avvertenza! Scollegare il cavo dell'alimentatore quando si sposta l'unità.



Warning! Only use attachments and accessories specified and/or sold by the manufacturer.

Avertissement! Utilisez seulement les attaches et accessoires spécifiés et/ou vendus par le fabricant.

Warnung! Verwenden Sie nur Zusatzgeräte und Zubehör angegeben und / oder verkauft wurde durch den Hersteller.

¡Advertencia! Utilice solamente los accesorios y conexiones especificados y/o vendidos por el fabricante.

Aviso! Utilize apenas equipamentos/acessórios especificados e/ou vendidos pelo fabricante.

Avviso! Utilizzare soltanto i collegamenti e gli accessori specificati e/o venduti dal produttore.



Warning! Do not defeat the safety purpose of the polarized or grounding-type plug. A polarized plug has two blades with one wider than the other. A grounding type plug has two blades and a third grounding prong. The wide blade or the third prong are provided for your safety. If the provided plug does not fit into your outlet, consult an electrician for replacement of the obsolete outlet.

Avertissement! La sécurité de la prise polarisée ou de la prise de type mise à la terre ne doit en aucun cas être empêchée de fonctionner. Une prise polarisée a deux broches, l'une étant plus large que l'autre. Une prise de type mise à la terre a deux broches et une troisième broche pour la mise à la terre. La broche large ou la troisième broche sont fournies pour votre sécurité. Si la prise fournie ne s'insère pas dans votre prise femelle, consultez un électricien pour le remplacement de la prise femelle obsolète.

Warnung! Der Sicherheitszweck des gepolten bzw. Schukosteckers ist zu berücksichtigen. Ein gepolter Stecker verfügt über zwei Pole, von denen einer breiter als der andere ist. Ein Schukostecker verfügt neben den zwei Polen noch über einen dritten Pol zur Erdung. Der breite Pol bzw. der Erdungspol dienen der Sicherheit. Wenn der zur Verfügung gestellte Stecker nicht in Ihren Anschluss passt, konsultieren Sie einen Elektriker, um den veralteten Anschluss zu ersetzen.

¡Advertencia! No eche por tierra la finalidad del tipo de enchufe polarizado con conexión a tierra. Un enchufe polarizado tiene dos espigas, una más ancha que la otra. Un enchufe con conexión a tierra tiene dos espigas iguales y una tercera espiga que sirve para la conexión a tierra. La espiga ancha, o la tercera espiga, sirven para su seguridad. Si el enchufe suministrado no encaja en el tomacorriente, consulte con un electricista para reemplazar el tomacorriente obsoleto.

Aviso! Não anule a finalidade da segurança da ficha polarizada ou do tipo ligação terra. Uma ficha polarizada tem duas lâminas sendo uma mais larga do que a outra. Uma ficha do tipo de ligação à terra tem duas lâminas e um terceiro terminal de ligação à terra. A lâmina larga ou o terceiro terminal são fornecidos para sua segurança. Se a ficha fornecida não couber na sua tomada, consulte um electricista para a substituição da tomada obsoleta.

Avviso! Non compromettere la sicurezza della spina polarizzata o con messa a terra. Una spina polarizzata ha due spinotti, di cui uno più largo. Una spina con messa a terra ha due spinotti e un terzo polo per la messa a terra. Lo spinotto largo o il terzo polo sono forniti per motivi di sicurezza. Se la spina fornita non si inserisce nella presa di corrente, contattare un elettricista per la sostituzione della presa obsoleta.



Warning! Since the Mains plug is used as the disconnection for the device, it must remain readily accessible and operable.

Avertissement! Puisque la prise principale est utilisée pour débrancher l'appareil, elle doit rester aisément accessible et fonctionnelle.

Warnung! Da der Netzstecker als Trennvorrichtung dient, muss er stets zugänglich und funktionsfähig sein.

¡Advertencia! Puesto que el enchufe de la red eléctrica se utiliza como dispositivo de desconexión, debe seguir siendo fácilmente accesible y operable.

Aviso! Dado que a ficha principal é utilizada como a desconexão para o dispositivo, esta deve manter-se prontamente acessível e funcional.

Avviso! Poiché il cavo di alimentazione viene usato come dispositivo di sconnessione, deve rimanere prontamente accessibile e operabile.



Warning! Protect the power cord from being walked on or pinched particularly at plugs, convenience receptacles, and the point where they exit from the device.

Avertissement! Protégez le cordon d'alimentation pour que l'on ne marche pas dessus ou qu'on le pince, en particulier au niveau des prises mâles, des réceptacles de convenance, et à l'endroit où il sort de l'appareil.

Warnung! Vermeiden Sie, dass auf das Netzkabel getreten oder das Kabel geknickt wird, insbesondere an den Steckern, den Steckdosen und am Kabelausgang am Gerät.

¡Advertencia! Proteja el cable de energía para que no se le pise ni apriete, en especial cerca del enchufe, los receptáculos de conveniencia y el punto del que salen del equipo.

Aviso! Proteja o cabo de alimentação de ser pisado ou de ser comprimido particularmente nas fichas, em tomadas de parede de conveniência e no ponto de onde sai do dispositivo.

Avviso! Proteggere il cavo di alimentazione in modo che nessuno ci cammini sopra e che non venga schiacciato soprattutto in corrispondenza delle spine e del punto in cui esce dal dispositivo.



Warning! Unplug this device during lightning storms or when unused for long periods of time.

Avertissement! Débranchez cet appareil pendant les orages avec éclairsou s'il est inutilisé pendant de longues périodes.

Warnung! Das Gerät ist bei Gewitterstürmen oder wenn es über lange Zeiträume ungenutzt bleibt vom Netz zu trennen.

¡Advertencia! Desenchufe este dispositivo durante tormentas eléctricas o cuando no se lo utilice por largos periodos del tiempo.

Aviso! Desconecte este dispositivo da tomada durante trovoadas ou quando não é utilizado durante longos períodos de tempo.

Avviso! Utilizzare soltanto i collegamenti e gli accessori specificati e/o venduti dal produttore, quali il treppiedi e l'esoscheletro.



Warning! Do not open the chassis. There are no user-serviceable parts inside. Opening the chassis will void the warranty unless performed by an AJA service center or licensed facility.

Avertissement! Ne pas ouvrir le châssis. Aucun élément à l'intérieur du châssis ne peut être réparé par l'utilisateur. La garantie sera annulée si le châssis est ouvert par toute autre personne qu'un technicien d'un centre de service ou d'un établissement agréé AJA.

Warnung! Öffnen Sie das Gehäuse nicht. Keine der Geräteteile können vom Benutzer gewartet werden. Durch das Öffnen des Gehäuses wird die Garantie hinfällig, es sei denn, solche Wartungsarbeiten werden in einem AJA-Service-Center oder einem lizenzierten Betrieb vorgenommen.

¡Advertencia! No abra el chasis. El interior no contiene piezas reparables por el usuario. El abrir el chasis anulará la garantía a menos que se lo haga en un centro de servicio AJA o en un local autorizado.

Advertência! Não abra o chassi. Não há internamente nenhuma peça que permita manutenção pelo usuário. Abrir o chassi anula a garantia, a menos que a abertura seja realizada por uma central de serviços da AJA ou por um local autorizado.

Avvertenza! Non aprire lo chassis. All'interno non ci sono parti riparabili dall'utente. L'apertura dello chassis invaliderà la garanzia se non viene effettuata da un centro ufficiale o autorizzato AJA.

Warranty and Liability Information

Limited Warranty on Hardware

AJA Video Systems, Inc. (AJA Video) warrants that the hardware product, not including software components, will be free from defects in materials and workmanship for a period of five years from the date of purchase. AJA Video provides a separate software warranty as part of the license agreement applicable to software components.

If the Customer brings a valid claim under this limited warranty for a hardware product (hereafter, a “product”) during the applicable warranty period, AJA Video will, at its sole option and as the Customer’s sole remedy for breach of the above warranty, provide one of the following remedies:

- Repair or facilitate the repair the product within a reasonable period of time, free of charge for parts and labor.
- Replace the product with a direct replacement or with a product that performs substantially the same function as the original product.
- Issue a refund of the original purchase price less depreciation to be determined based on the age of the product at the time remedy is sought under this limited warranty.

To obtain service under this warranty, the Customer must notify AJA Video of the defect before expiration of the warranty period and make suitable arrangements for the performance of service by contacting AJA Video support through the channels set forth on the support contacts web page at <https://www.aja.com/support>. Except as stated, the Customer shall bear all shipping, packing, insurance and other costs, excluding parts and labor, to effectuate repair. Customer shall pack and ship the defective product to a service center designated by AJA Video, with shipping charges prepaid. AJA Video shall pay to return the product to Customer, but only if to a location within the country in which the AJA Video service center is located. **SOME JURISDICTIONS DO NOT ALLOW THE EXCLUSION OF IMPLIED WARRANTIES OR LIMITATIONS ON APPLICABLE STATUTORY RIGHTS OF A CONSUMER, SO SOME OR ALL OF THE TERMS OF THIS PARAGRAPH MAY NOT APPLY TO YOU.**

Limitation of Liability

Under no circumstances shall AJA video BE LIABLE IN ANY WAY FOR ANY LOST, CORRUPTED OR DESTROYED DATA, FOOTAGE OR WORK, OR FOR ANY OTHER INDIRECT, SPECIAL, INCIDENTAL OR CONSEQUENTIAL DAMAGES OR LOST PROFITS, OR FOR ANY THIRD PARTY CLAIM, IN CONNECTION WITH THE PRODUCT, WHETHER RESULTING FROM DEFECTS IN THE PRODUCT, SOFTWARE OR HARDWARE FAILURE, OR ANY OTHER CAUSE WHATSOEVER, EVEN IF AJA VIDEO HAS BEEN ADVISED OF THE POSSIBILITY OF SUCH DAMAGES. AJA VIDEO’S LIABILITY IN CONNECTION WITH THE PRODUCT SHALL UNDER NO CIRCUMSTANCES EXCEED THE PURCHASE PRICE PAID FOR THE PRODUCT. The foregoing limitations apply even if any remedy set forth in this LIMITED WARRANTY fails of its essential purpose. **SOME JURISDICTIONS DO NOT ALLOW THE LIMITATION OF LIABILITY FOR PERSONAL INJURY, OR OF INCIDENTAL OR CONSEQUENTIAL DAMAGES, SO SOME OR ALL OF THE TERMS OF THIS PARAGRAPH MAY NOT APPLY TO YOU.**

Governing Law and Language; Your Rights

This limited warranty is the only warranty provided by AJA Video on the hardware product. It supersedes all prior or contemporaneous understandings regarding such subject matter. No amendment to or modification of this warranty will be binding unless in writing and signed by AJA Video. The laws of the State of California, USA will govern this warranty and any dispute arising from it. Any translation of this Agreement is intended for convenience and to meet local requirements and in the event of a dispute between the English and any non-English versions, the English version of this warranty will govern. This limited warranty gives you specific legal rights and you may have other rights that vary from jurisdiction to jurisdiction, some of which are noted above.

Index

Symbols

11 51

A

Advantages of IR-Over-IP 36
Advantages of Serial Control Over IP 38
Advantages of USB Over IP 40
AJA Dante Audio Equipment 14
AJA Support 2
Already Familiar with Dante Controller for Audio? 29
Applying Presets 43
Audio Input or Output IP 55
Audio Routing 35
Automatic Discovery 18
Automatic network configuration 18
Automatic Notification of Device Errors 47

B

Base and Surface Mount Installation 12

C

Cabling 13
Codec 55
Compatibility 6
Computer Configuration 49
Contacting AJA Support 2
Correct IP configuration 50
Create a Multicast 32, 33

D

Dante Applications for PC or Mac 46
Dante Audio 5
Dante AV 4K-R AJA Config Controls 26
Dante AV 4K-R Connectors 8
Dante AV 4K-R Rear Panel LEDs 11
Dante AV 4K-T AJA Config Controls 23
Dante AV 4K-T and Dante AV 4K-R Front Panel LEDs 9
Dante AV 4K-T Connectors 7
Dante AV 4K-T Rear Panel LEDs 10
Dante AV Ultra 5
Dante Controller 46
 Training Videos 52
Dante Controller Software 15
Dante Firmware Update Manager Application 52
Dante Studio Applications (Windows Only) 46
Dante Updater Application 52
Dante Via 46

Dante Video Training by Audinate 52
Dante Virtual Soundcard 46
Device Roles 42
Digital Video Playback and Recording Devices 14
Discovery and Auto-Configuration 18
Discovery, Registration and Control 53
DO NOT STACK 12

E

Energy Efficient Ethernet (EEE) Switches 52
Environment 56
Events Tab 52
Expected Bandwidth 6

F

Familiar with Dante Controller for Audio? 30
Features 5
Flows 30

G

Guidelines for Using the Ethernet Ports 17

H

Hardware Component Requirements 15
How do I check IP addresses 51

I

Implementing IR-Over-IP 36
Implementing Serial Control Over IP 38
Implementing USB Over IP 40
Incorrect General IP Configuration 50
Incorrect PC/Mac IP Configuration 50
Installation 12
Installing Dante Controller 15
Interoperability 46
Introduction to Video Multicasting 31
I/O Connections 7
IP Network Configuration: Possible Mistakes 50
IR-Over-IP Dante Controller Routing 37
IR-Over-IP Setups 36

K

KVM 40
KVM: USB over IP 40

L

Launch and Use Dante Controller 17
Launching Dante Controller 19
LED Indicators 9
Live Concert Touring System 47

M

Media Transport Interfaces 53
Mini-Guide to Dante Controller 52
Multicasting a Dante AV 4K-T 32

N

Network Configuration 49
nfrared: IR-Over-IP 36
Notices 2

O

On-Screen Warning and Error Indicators 47
Opening AJA Config Tab for Dante AV 4K-R 25
Opening AJA Config Tab for Dante AV 4K-T 23
Optional Equipment and Software to Prepare 14
Overview 5
Overview of the Dante Controller Application 19

P

Parts List 12
Physical Setup 12
Power 56
Power Up 17

Q

Quick Start Guide 52

R

Rack Mount Installation 13
Reference 55
Required Software 15
Requirements 12
Routing For Video Devices 31, 32
Routing Video With Multicast 34

S

Safety and Compliance 57
Saving Presets 43
Serial Control over IP 38
Serial-Over-IP Dante Controller Routing 39
Serial-Over-IP: Example PTZ Camera Setups 38
Size (W x D x H) 56
Specifications 53
Switch Checklist 52

Symptoms of Switch or Cabling Issues 52
symptoms of using the wrong network interface 50
System Setup 13

T

Technical Support 2, 52
Tech Specs 53
Third Party Software Applications
46
Trademarks 2
Troubleshooting 47
Troubleshooting Dante IP Address
Configuration 49
Troubleshooting Switch
Configuration and Cabling 51
Troubleshoot Using the Dante AV
4K-T/R LEDs 47
Troubleshoot Using the Dante
Controller Application 47

U

Uninstalling Dante Controller 16
Unpacking 12
USB-Over-IP Dante Controller
Routing 41
USB Over IP Setups for KVM 40
User Controls 12
User Interface 56
User Presets 42, 52
Using Dante Controller 17, 19
Using POE+ 17

V

Video Channels are Routed like
Audio Channels 30
Video Channels Are Unicast by
Default 31
Video Codecs 6
Video Formats 53
Video Input or Output IP 54
Video Input & Output Digital 53
Video Signal Enhancement 14
Video Transport 6

W

Warranty and Liability Information
64
Weight 56
What can I do with Presets? 42
When are Presets Helpful? 42