

SWIT®

SL-100P/SL-150P

Flexible Bi-Color SMD LED Light

Ver: B

USER MANUAL

SWIT Electronics Co.,Ltd.Tel:+86-25-85805753
Fax:+86-25-85805296
http://www.swit.cc
E-mail: contact@swit.cc

Congratulations on your purchase of this product. Please read this user manual carefully.

Specification

| Model | SL-100P | SL-150P |
|---------------------|-------------------------------------|------------------|
| Number of the lamps | 560pcs | 840pcs |
| Color Temperature | 2700K-6500K | |
| Brightness | 0%-100% | |
| Luminance | 2800 Lux/1m | 4100 Lux/1m |
| Beam angle | 10°-360° | |
| CRI | 97 | |
| TLCI | 97 | |
| Input Power | 100W | 150W |
| Working Voltage | DC 11-36V/AC100-240V(50/60Hz) | |
| Dimensions | 600mm x 470mm | 600mm x 690mm |
| Weight | Light body:0.4g | Light body:0.7Kg |
| | Controller:1.06Kg Adaptor:0.58Kg | |

General Precautions

- 1.Do not disassembly the light or touch the interior of the light with metal objects to prevent causing damage;
- 2.Please avoid storing the light in dusty and wet environment to prevent causing damage;
- 3.Please avoid scratching the light body with hard object to prevent affecting the using effect;
- 4.Slight oil stains on the surface of the lamp body can be wiped with a clean cloth ;
- 5.This products can only be using in the temperature range of -10°C-40°C.

Overview

1.Front view

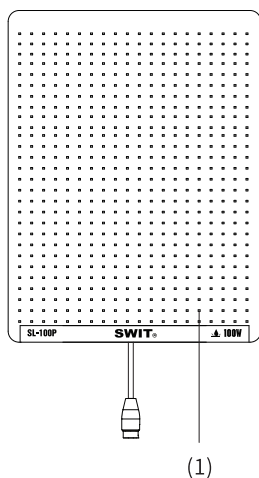

Fig.1 SL-100P

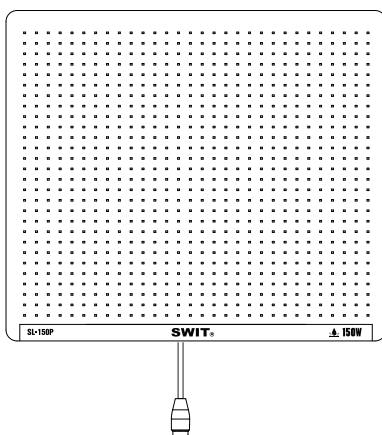

Fig.2 SL-150P

2.Back view (SL-100P)

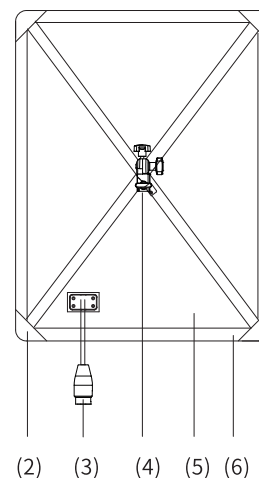

Fig.3 SL-100P

3.Front view

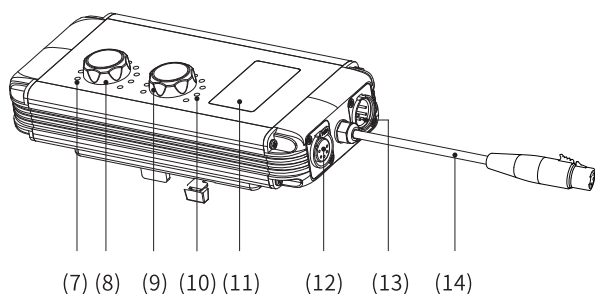

Fig.4 Controller

- ①Light strips
- ②Warp corner
- ③Light input connection cable
- ④X bracket
- ⑤Light body
- ⑥Magic sticker
- ⑦Color temp indicator light
- ⑧Color temp knob
- ⑨Brightness knob
- ⑩Brightness indicator light
- ⑪ LCD screen
- ⑫DMX OUT

4.Back view

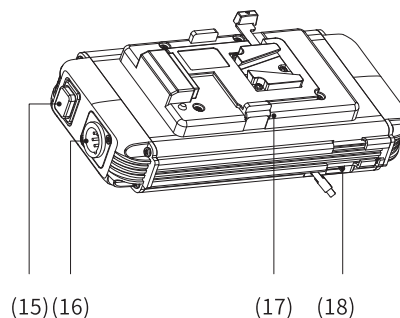

Fig.5 Controller

- ⑬DMX IN
- ⑭Control box output cable
- ⑮Power switch
- ⑯DC 11-36V IN
- ⑰Battery plate
- ⑱USB interface

LCD display information

Take “CCT=5600K, Dimmer=100%, DMX address:008 (Group:8)” as an example:

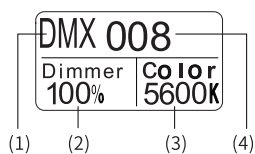

Fig.6 DMX Mode



Fig.7 Brightness Interface



Fig.8 DMX Address Interface

- ① Control Mode—DMX Mode
- ② Current Brightness
- ③ Current Color Temperature
- ④ Current DMX Address
- ⑤ Current setting number
- ⑥ Control Mode—
Group Control Mode
- ⑦ Group Number

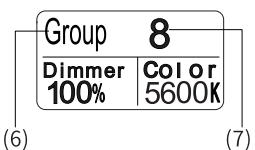

Fig.9 Group Control Mode



Fig.10 Color temperature interface



Fig.11 Group Interface

Using Instruction

1 Installation

Any bend of this products will have no effects during using. Light can be fixed on back of a chair, top of the car or any narrow space, or as shown on Fig.3, hold up with the X-bracket.

Tip: Users who choose arc soft cover and egg soft box should first hold up the lamp body as shown in Fig.3, and then assemble the arc soft cover and egg soft box. The light box can be used normally by fixing it on the lamp body with Magic Stick.

2 Power

2.1 Power supply

The products can be powered by batteries and AC adaptor.

2.2 Usage

Connect the control box output cable (Fig.4⑭) with light input connection cable (Fig.3③) after installation according to the requirements, switch on the light (Fig.5⑮), set the light parameters, then it can be used normally.

3 Parameters and working mode setting

3.1 Setting and usage of Brightness & Color Temperature

Color temperature/Brightness can be controlled by Color temperature/Brightness knob (Fig.4⑧/⑨). The range of

Color Temperature & Brightness are shown as below:

- Color Temperature adjusting range: 2700K-6500K, Min adjusting steps: 50K;
- Brightness adjusting range: 0%-100%, Min adjusting steps: 1%.

3.2 DMX Address Setting

See 4.1

3.3 GROUP Setting

See 5.1

3.4 Working Mode Setting

Hold color temperature adjusting knob (Fig.4 ⑧) for 2s, then DMX mode (Fig.6) or Group Mode (Fig.9) can be switched.

4 DMX Communication Mode

4.1 DMX Address setting

Hold the brightness adjusting knob (Fig.4 ⑨) for about 2s to enter in the DMX address setting interface (Fig.8), set DMX address with Brightness adjusting knob (Fig.4 ⑨), DMX communication address adjusting range: 001-512.

- Set the number of current bit with brightness adjusting knob (Fig.4 ⑨);
- Press brightness adjusting knob (Fig.4 ⑨) to confirm the number of current bit and enter in the setting of next bit number;
- Exit DMX communication setting interface:

Stop operating or change the setting number to the last bit then press the brightness adjusting knob.

4.2 Usage of DMX Communication Mode

Complete the DMX address parameter setting of the product according to the expected demand, connect the lamp and DMX control equipment reliably through DMX line, then it can be used normally.

This product occupies a total of two DMX control channels, currently set the DMX address (N) for brightness control, address (N+1) for color temperature control, such as:

| DMX Address | DMX Channel | Function |
|-------------|-------------|--|
| 008 | 008 | Brightness adjusting: 0%-100% |
| | 009 | Color temperature adjusting: 2700K-6500K |

5 GROUP Control Mode

5.1 GROUP Control Mode Parameters Setting

Hold the Brightness adjusting knob (Fig.4 ⑨) for about 2s to enter in Group parameters setting group interface (Fig.11), adjust the brightness knob (Fig.4 ⑨) to set Group parameters, Group parameters setting range: 1-8, Stop operating or change the setting number to the last bit then press the brightness adjusting knob.

5.2 GROUP Control mode Usage

Set the parameters of the Group according to the expected demand, set the target light to be controlled into the same Group, network the light through DMX cable, and the light can be used normally without distinguishing the master and slave machines.

Tips: When using the group control function of the light, do not access the output device of DMX signal in the light network, otherwise the function cannot be used normally.

6. USB Interface usage

USB Interface (Fig.5 ⑱) is for specific use, Please use it according to the specified environment of the relevant products of our company. Do not use it for other purposes to avoid losses.

Packing list

| No. | Details | Quantity |
|-----|-------------------|--|
| 1 | X-bracket | x 1 |
| 2 | Clam | x 1 |
| 3 | Power Cable | x 1 |
| 4 | Adaptor | x 1 |
| 5 | Light bag | x 1 |
| 6 | Softbox (Option) | Customers can purchase separately according to their needs |
| 7 | Eggcrate (Option) | |