

INSPIRE
YOUR
IMAGINATION

BRIDGING
TECHNOLOGY™



Manfrotto
Imagine More

BRIDGING TECHNOLOGY

Manfrotto Videolösungen kombinieren exklusives und ergonomisches Design mit professioneller Leistung für präzise und kontrollierte Video Shootings.

Der Übergang in eine neue Dimension der Filmproduktion.

“BRIDGING TECHNOLOGY”.

Die perfekte Synthese zwischen einer hoch innovativen Stativkopf-Konstruktion und topaktueller Manfrotto-Technik.



EINZIGARTIGE FEATURES FÜR EINZIGARTIGES FILMATERIAL



Längere Kameraplatte
für eine bessere Balance.





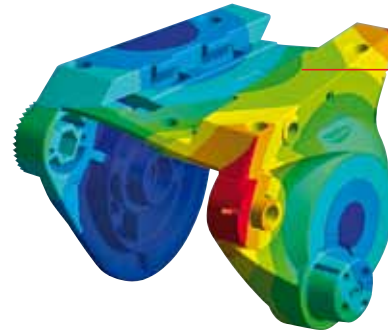





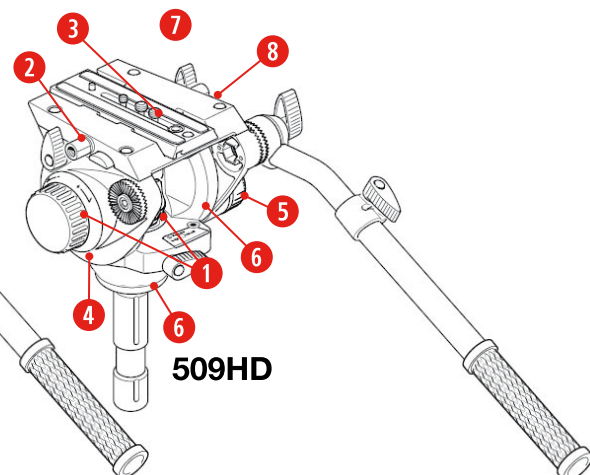
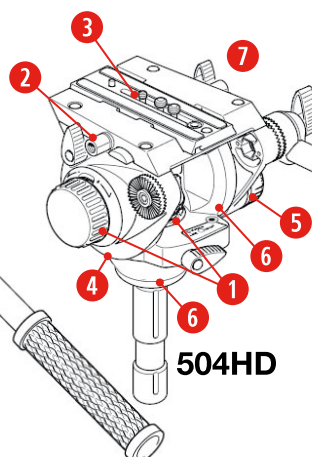
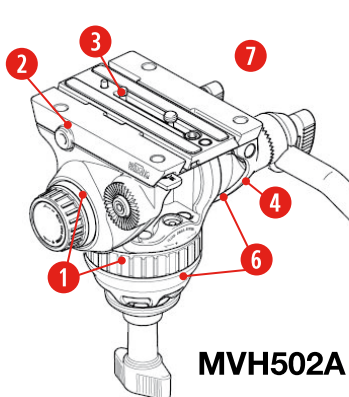



Easy-Link Gewinde für
die Befestigung von Video-
DSLR und Film-Zubehör.



Sehr stabiler
Aufbau

- 1 Horizontale und vertikale Fluid-Frictionseinstellung für eine noch ergonomischere Bedienung
- 2 Easy-Link Gewinde für eine flexible Befestigung des Zubehörs
- 3 Breite Kameraauflage, lange sowie verschiebbare Kameraplatte für mehr Stabilität und Balance bei der Benutzung des Video- oder Fotoequipments
- 4 Stabiler Aufbau für maximale Präzision und verbesserte Reaktionsfähigkeit
- 5 Gegengewichtsausgleich für schnelles "Setup" und optimale Balance
- 6 Kugelgelagertes Friktionssystem für weiche Bewegungen
- 7 Leichte, moderne Materialien für ein ideales Verhältnis zwischen Stabilität und Gewicht
- 8 ABR (Advanced Balancing Recorder) für eine sehr schnelle und äußerst präzise Fixierung des Equipments. Effizient und zeitsparend.



		MVH502A	504HD	509HD
				
	Friktionskontrolle auf Schwenk- und Neigeachse	Variable Fluid-Friktionskontrolle	Variable Fluid-Friktionskontrolle	Variable Fluid-Friktionskontrolle
	Konterbalance-System	einstufig (an-aus)	vierstufig	vierstufig
		4kg - 8.8lb	7.5kg - 16.5lb	13kg - 28.8lb
	Halbkugel	Ø 75mm	Ø 75mm	Ø 100mm
	ABR (Advanced Balancing Recorder)	nicht enthalten	nicht enthalten	enthalten
	Schnellwechselplatte	504 PLONG	504 PLONG	504 PLONG
		(140mm - 5.5in)	(140mm - 5.5in)	(140mm - 5.5in)
	Easy Link Verbindungen	2 x 3/8" Gewinde	2 x 3/8" Gewinde	2 x 3/8" Gewinde
	Nivellierlibelle	enthalten	enthalten (beleuchtet)	enthalten (beleuchtet)
	Material			

SYMBOLSCHLÜSSEL



Kopfhöhe

Gewicht

Maximale Belastbarkeit

Platte im Lieferumfang

Min. Höhe

Max. Höhe

Magnesium

Carbonfaser

Aluminum

BRIDGING TECHNOLOGY™

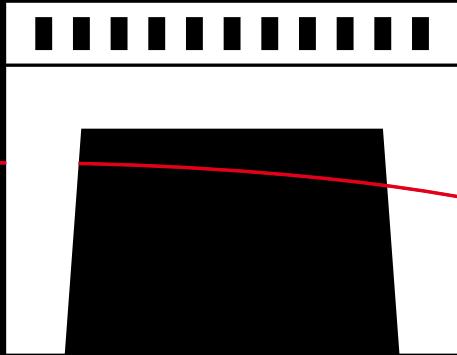

Mit der Einführung immer leichter und kompakterer Kameras hat sich die Videotechnik in den letzten Jahren radikal verändert. Durch den Einsatz hochmoderner Kameras hat sich ein neuer Arbeitsstil in der Filmproduktion herausgebildet, da heute oftmals eine einzige Person eine Arbeit erledigen kann, für die vor einigen Jahren noch eine ganze Filmcrew notwendig war.

Die Videobranche entdeckt nun eine neue Dimension!

Manfrotto, Marktführer auf dem Gebiet leichter und vielseitiger Foto- und Videostative, führt ein neues Sortiment hochwertiger Videosysteme ein, das speziell für die allerneueste Generation der Camcorder, 3D Rigs und Video-DSLR entwickelt wurde. Aufgrund der ergonomischen und technischen Eigenschaften sind diese Systeme die perfekte Ausrüstung für die „neue“ Videobranche.

“BRIDGING” SYSTEME

Manfrotto freut sich, die “500” Serie präsentieren zu dürfen, deren Systeme eine perfekte Synthese zwischen hoch innovativen Stativkopf-Konstruktionen und der topaktuellen Manfrotto-Technik darstellen. Das Ergebnis dieser wichtigen Entwicklung ist die Bridging-Technologie, ein weiteres, exklusives Manfrotto-Patent. Eine neue, technologische Dimension, die es Anwendern moderner High-Definition Kameras ermöglicht, noch bessere Ergebnisse zu erzielen.

VIDEOSYSTEME MIT DOPPELROHR-AUSFÜHRUNG

Bei der Entwicklung unserer neuen Systeme war uns besonders wichtig, ein Komplettpaket anbieten zu können. Unsere neuen zweistufigen Stative 545 und 546 sind die perfekte Ergänzung zu den Video-Köpfen der "Bridging-Technology" und in zwei Varianten erhältlich: mit Mittelspinne oder Bodenspinne.

1 NIVELLIERSYSTEM

Das Nivelliersystem verfügt über eine 100mm oder 75mm Halbschale, wodurch in jedem Winkel perfekte Stabilität garantiert wird.

2 SCHNELLVERSCHLÜSSE FÜR STATIVBEINE

Unsere neuen Verschlüsse sind ergonomischer konzipiert, schneller einsatzbereit und besser verstellbar. Für eine optimale Leistung bei einer Stativbelastung von bis zu 25kg.

3 EINSTELLBARE VERRIEGELUNGSSTÄRKE DER SCHNELLVERSCHLÜSSE

Ein weiteres Detail, durch das Ihr Manfrotto-Stativ garantiert jeden Vergleich gewinnt: mit Schrauben, die hinter den Schnellverschlüssen an jedem Bein angebracht sind, können Sie die Verriegelungsstärke stets anpassen. Auch nach jahrelangem Gebrauch ist Ihr Stativ noch immer so stabil und verlässlich wie am ersten Tag.

4 TELESKOP-SPINNE

Wichtige Verbesserungen wurden bei der Neukonzipierung der Mittelspinne erreicht, die nun viel stabiler ist und eine flexible Verbindung zwischen den Stativbeinen darstellt. Teleskop-Bodenspinnen sind ebenfalls erhältlich.

5 STANDFESTIGKEIT

Dank Spikes und Gummifüßen verfügen die Stative 545 und 546 über einen perfekten Halt auf jedem Terrain.

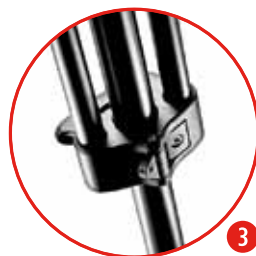

**509HD
SYSTEME**







509HD, 545BK







509HD, 545GBK

509HD, 545BK SYSTEM

			
13kg 28.6lb	45cm 17.7in	169cm 66.5in	8.2kg 18lb

509HD, 545GBK SYSTEM

			
13kg 28.6lb	47.5cm 18.7in	173.5cm 68.3in	8.1kg 17.8lb

**504HD
SYSTEME**







504HD, 546BK







504HD, 546GBK

504HD, 546BK SYSTEM

			
7.5kg 16.5lb	44cm 17.3in	167.5cm 65.9in	6.3kg 13.9lb

504HD, 546GBK SYSTEM

			
7.5kg 16.5lb	46.5cm 18.3in	171cm 67.3in	6.3kg 13.9lb

**MVH502A
SYSTEME**
Verfügbar ab
Herbst 2011







MVK502AM
inkl. Tasche



MVH502A, 546BK
inkl. Tasche

MVK502AM SYSTEM

			
4kg 8.8lb	63cm 24.8in	157cm 62in	4kg 8.8lb

MVH502A, 546BK SYSTEM

			
4kg 8.8lb	44cm 17.3in	168cm 66.1in	5.5kg 12.1lb

VIDEOSYSTEM IN EINZELROHR – AUSFÜHRUNG

Einfache Worte für ein außergewöhnlich flexibles Manfrotto-System. Die Kombination der Videoköpfe mit einem Carbon-Stativ ist das Non Plus Ultra einer leichten Ausrüstung. Die Stativ verfügen über eine hohe Verdrehsteifigkeit sowie vielseitige Möglichkeiten der Höhenverstellbarkeit (von 40cm bis 217.5cm).







509HD SYSTEME



509HD, 536K

509HD, 536K SYSTEM

 13kg 28.6lb	 42cm 16.5in	 218cm 85.8in	 7.9kg 17.4lb
---	---	--	--

504HD SYSTEME







504HD, 535K







504HD, 536K

504HD, 535K SYSTEM

 7.5kg 16.5lb	 40.5cm 15.9in	 184cm 72.4in	 5kg 11lb
--	---	--	--

504HD, 536K SYSTEM





 7.5kg 16.5lb	 40cm 15.7in	 217.5cm 85.6in	 6.1kg 13.4lb
--	---	--	--

MVH502A SYSTEME



MVK502C

MVK502C SYSTEM

 4kg 8.8lb	 41cm 16.2in	 185cm 72.8in	 4.3kg 9.5lb
---	---	--	---

Auf einer innovativen Online-Plattform hat Manfrotto das Können der weltweit besten Fotografen und Videofilmer vereint.

Dazu zählen:

Harry De Zitter,

Bill Frakes,

Joe McNally,

Drew Gardner,

Roberto Bigano,

Ami Elsius,

Marc de Tollenaere,

Kristoff Ramon,

David Duchemin,

Milko Marchetti,

Uri Golman,

Adam Barker,

Kazuyuki Okajima und viele andere.



Manfrotto
SCHOOL OF XCELLENCE
manfrottoschoolofexcellence.com