



F1

Field Recorder

Quick Guide

You must read the Usage and Safety Precautions before use.

The Operation Manual can be downloaded from the ZOOM website (www.zoom.co.jp).

© 2017 ZOOM CORPORATION

Copying or reprinting this manual in part or in whole without permission is prohibited.

Preparations

1. Remove the battery cover, and insert batteries.

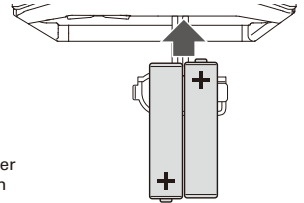
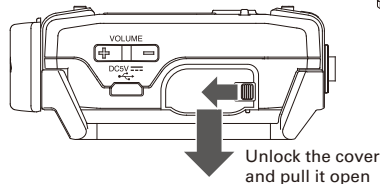

HINT

A ZOOM AD-17 AC adapter can also be used.

2. Open the microSD card slot cover, and insert a microSD card.

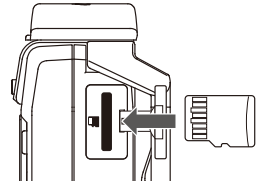



3. Slide  toward  to turn the power on.

HINT

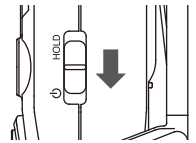
Slide  toward HOLD to disable the keys and prevent misoperation during recording.



4. Set the language displayed.

Select the language: Press  or 

Confirm: Press 



5. Set the date and time.

Move cursor: Press  or 

Change value: Press  or 

Confirm: Press 



HINT

Language and date and time settings can be changed later from the menu screen.

To open the menu screen, press  while pressing .

Assembly and connections

Shock mount

This can reduce noise when the **F1** is mounted on a digital SLR camera.

1. Attach the ends of two arms from the shock mount to one **F1** belt loop.

2. Attach the other arms one at a time to the other belt loop.

Using the elasticity of the arms, attach their ends to the belt loops while bending them slightly.

3. Slide the shock mount onto the camera accessory shoe and tighten the screw to attach it.

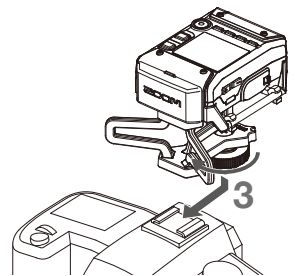
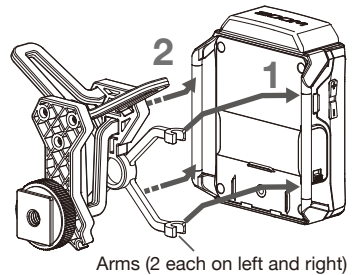

Mic capsules

1. Remove the protective caps from the **F1** and the mic capsule.

2. While pressing the buttons on the sides of the mic capsule, connect it to the **F1**, inserting it completely.

3. To disconnect the mic capsule, pull it away from the unit while pressing the buttons on its sides.

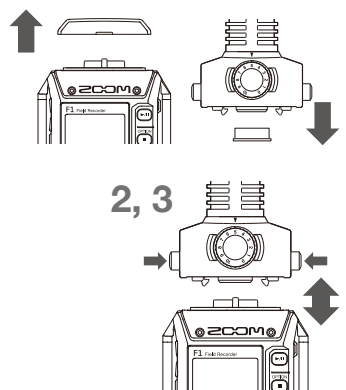

Lavalier mics

1. Attach the windscreen and the clip to the lavalier mic.

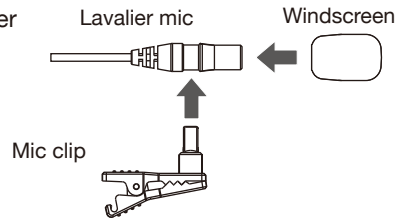

2. Attach the belt clip to the **F1** with the screw.

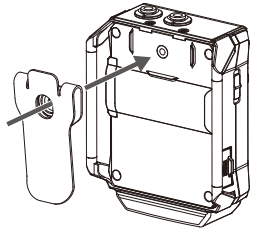

3. Connect the lavalier mic to the MIC/LINE IN jack, and tighten the screw lock.

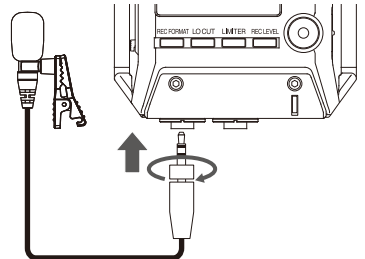

HINT

- Press **LIMITER** while pressing **[■]**, and select ON to provide plug-in power to a mic that uses it.
- Mics without screw locks can also be connected to the MIC/LINE IN jack.

Input and output settings

Adjusting input levels

Adjust the level of the signal input to the **F1**.

HINT

- Adjust so that the peak level stays around -12 dB.
- If the REC LED flashes, the sound could become distorted, so lower the input level.

■ When using a mic capsule

1. Turn  on the mic capsule to adjust the input level.

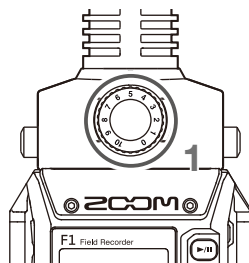

■ When using a lavalier mic

1. Press , and select the input level.

NOTE

- To change the setting, press the same key again while the parameter appears enlarged.
- Select "AUTO" if you want the input level to be adjusted automatically.





■ Adjusting the side mic level (stereo width) of a mid-side mic capsule.

1. When the mic capsule is connected, press , and select the side mic level.



■ Monitoring audio while recording

1. Connect headphones to the PHONES OUT jack.
2. Use  and  to adjust the volume.

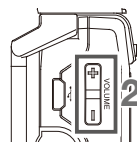
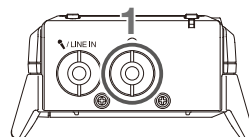

Adjusting the levels of connected devices

Play the test tone in order to adjust the level of a digital SLR camera or other device connected to the **F1**.

1. Minimize the input gain of the other device.

NOTE

If the automatic gain control function on the other device is on, turn it off.

2. Use an audio cable to connect the external mic jack of the other device with the PHONE OUT jack of the **F1**.

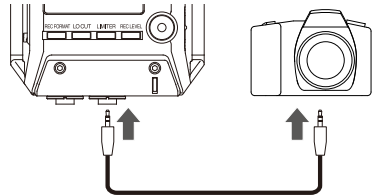

3. While pressing , press .

This plays a test tone from the PHONE OUT jack.



NOTE

Be careful of the volume if you are monitoring the sound with headphones, for example.

4. Use  and  to adjust the input level.

While checking the audio level meter of the other device, adjust the audio signal level so that it never exceeds -6 dB.



5. Adjust the input gain of the other device.

While checking the audio level meter of the other device, adjust the audio signal level in small increments until it is about -6 dB.

6. While pressing , press .

Stop test tone playback.



NOTE

See the operation manual of the other device for information about its operation.

Recording

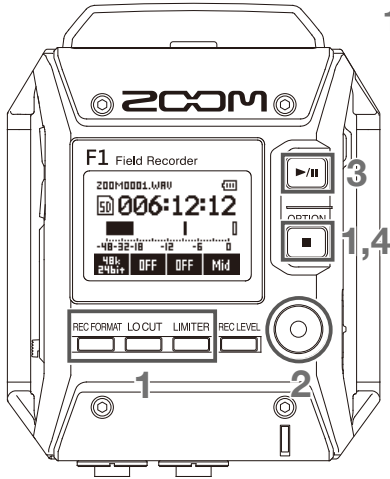

1. Make recording settings

- **Recording format:** Press

HINT

The MP3 format compresses data, so the sound quality is lower than WAV format, but it also uses less SD card space. Higher values provide better audio quality in both WAV and MP3 formats.

- **Low-frequency cut:** Press

This can reduce noise from wind and vocal pops.

- **Limiter:** Press

This prevents clipping caused by sudden loud noises.

- **Pre-recording:** While pressing , press

Recording will start about 2 seconds before is pressed.

2. Press to start recording.

3. Press to pause/resume recording.

Pausing will automatically add a mark.

During playback, you can jump to the positions of added marks.

HINT

The function that adds a mark when is pressed to pause can be changed on the menu screen

4. Press to end recording.

Playing recordings

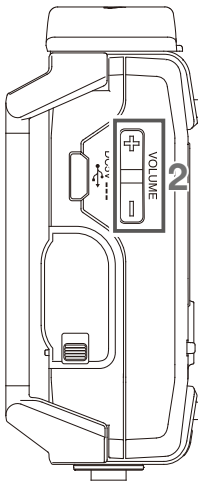
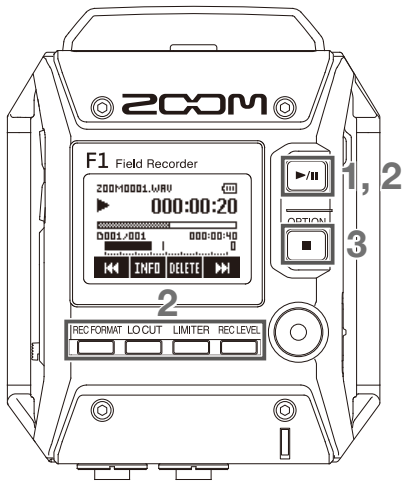

1. Press to start playback.
2. Control playback.

Adjust the volume	Use and
Pause/resume playback, add a mark	Press
Search forward/backward	Press and hold or
Select files/jump to marks	Press and If a file has marks, jumping to marks will occur first.
Delete a mark	Press when paused at a mark
Delete a file	Press
Check file information	Press Change page: Press or Return to the playback screen: Press

HINT

The function that adds a mark when is pressed to pause can be changed on the menu screen.

3. Press to stop playback.

Using USB functions

1. Use a USB cable to connect a computer or iOS device.

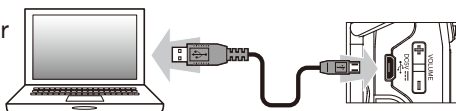

2. Select the function to use.

Move cursor: Press ^{LOCUT} or ^{LIMITER}
 Confirm: Press ^{REC LEVEL}



■ Card reader

You can use a computer to exchange data with the **F1**.

To disconnect the **F1**, end the connection on the computer first, and then press ^{REC LEVEL}.

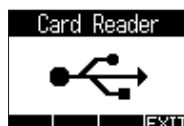

■ Audio interface

F1 input signals can be sent directly to a computer or iOS device, and playback signals from that computer or device can be output from the **F1**.

1. Set the type of device used.

Move cursor: Press ^{LOCUT} or ^{LIMITER}
 Confirm: Press ^{REC LEVEL}



NOTE

After selecting "iOS", turn the **F1** power on, follow the instructions on screen, and disconnect the cable once. Then, select "iOS" again and reconnect the cable.

2. Set the power source if using a PC/Mac.

Move cursor: Press ^{LOCUT} or ^{LIMITER}
 Confirm: Press ^{REC LEVEL}





3. To set direct monitoring, press ^{REC FORMAT} while pressing .

This enables monitoring without latency by directly outputting the **F1** input signal before sending it to the computer or iOS device.



To disconnect the **F1**, press ^{REC LEVEL} while pressing .

Other functions and settings

While pressing , press  to open the menu screen where you can use the following functions and settings.

Menu item		Explanation
Record/Play	Rec File Name	Set the recording file name format.
	Rec File	Set the recording file format (stereo/mono).
	Rec Hold	Automatically hold keys during recording to prevent misoperation.
	Sound Marker	Output half-second tone signals when starting and stopping recording.
	Rec Counter	Set how the counter appears on the display.
	PLAY Key Option	Set the function when  is pressed during recording/playback.
	Playback Mode	Set the file playback mode.
Date/time	Set Date/Time	Set the date and time added to recording files.
	Date Format	Set the format of the date shown for file names and on the Playback Screen.
LCD	Backlight	Set the time until the display backlight turns off.
	Contrast	Set the display contrast.
Battery		Set the type of batteries used.
Auto Power Off		Set to turn off automatically if not used for a certain amount of time.
SD card	Format	Format a microSD card for use with the F1 .
	Test	Test whether a microSD card can be used with the F1 .
Version		Check the firmware version.
Language		Set the language shown on the display.
Factory Reset		Restore F1 settings to factory defaults.

Specifications

Recording media	microSD/microSDHC cards (Class 4 or higher, up to 32 GB)		
Recording formats	WAV	44.1 kHz/16-bit, 48 kHz/16-bit, 48 kHz/24-bit, 96 kHz/24-bit Mono/stereo BWF format supported	
	MP3	48 kbps, 128 kbps, 192 kbps, 256 kbps, 320 kbps Mono/stereo ID3v1 tags supported	
Display	1.25" monochrome LCD (96×64) with REC LED (red)		
Inputs	MIC IN	ZOOM mic capsule input	
	MIC/LINE IN	Connector	3.5 mm stereo mini (with screw lock) Supports plug-in power (2.5 V)
		Input gain	-12 dB – +36 dB
		Input impedance	Input impedance: 2 kΩ or more
Output	PHONE OUT	Connector	3.5 mm stereo mini (with screw lock)
		Maximum output level	11 mW + 11 mW (into 32Ω load)
USB	microUSB		
	Mass storage operation	USB 2.0 High Speed	
	Audio interface operation	USB class compliant 44.1/16-bit, 48kHz/16-bit, 2-in/2-out Transfer method: asynchronous	
Power	2 AAA batteries (alkaline, NiMH or lithium) AC adapter (ZOOM AD-17): DC 5V/1A		
Estimated continuous recording time using batteries	With SGH-6 mono shotgun mic capsule connected (48 kHz/24-bit, mono) Alkaline batteries: about 6.5 hours NiMH batteries 750 mAh): about 6 hours Lithium batteries: about 11 hours		
	When using lavalier mic (48 kHz/24-bit, mono, plug-in power on) Alkaline batteries: about 10 hours NiMH batteries 750 mAh): about 9 hours Lithium batteries: about 16 hours		
	<ul style="list-style-type: none"> • The above values are approximate. • Continuous battery operation times were determined using in-house testing methods. They will vary greatly according to use conditions. 		
External dimensions	64.0 mm (W) × 79.8 mm (D) × 33.3 mm (H)		
Weight (main unit only)	120 g		



ZOOM CORPORATION

4-4-3 Kanda-surugadai, Chiyoda-ku, Tokyo 101-0062 Japan

www.zoom.co.jp