

dji INSPIRE 3

User Manual

v1.0 2023.04

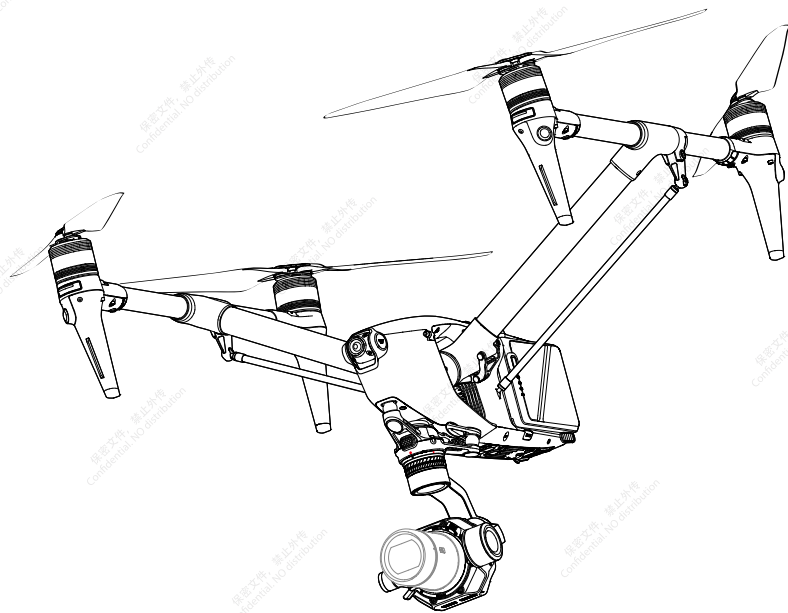



This document is copyrighted by DJI with all rights reserved. Unless otherwise authorized by DJI, you are not eligible to use or allow others to use the document or any part of the document by reproducing, transferring or selling the document. Users should only refer to this document and the content thereof as instructions to operate DJI UAV. The document should not be used for other purposes.

Searching for Keywords

Search for keywords such as “battery” and “install” to find a topic. If you are using Adobe Acrobat Reader to read this document, press Ctrl+F on Windows or Command+F on Mac to begin a search.

Navigating to a Topic

View a complete list of topics in the table of contents. Click on a topic to navigate to that section.

Printing this Document

This document supports high resolution printing.

Using This Manual

Legends

⚠ Important

💡 Hints and Tips

Read Before Use

DJI™ provides users with tutorial videos and the following documents.

1. Safety Guidelines
2. Quick Start Guide
3. User Manual

It is recommended to watch all the tutorial videos and read the Safety Guidelines before using for the first time. Prepare for your first flight by reviewing the quick start guide and refer to this manual for more information.

Tutorial Videos

Go to the address below or scan the QR code to watch the DJI Inspire 3 tutorial videos, which demonstrate how to use the Inspire 3 safely.



<https://s.dji.com/guide26>

Downloading DJI Assistant 2

Download and install DJI ASSISTANT™ 2 (Inspire Series) using the link below:

<https://www.dji.com/inspire-3/downloads>

- ⚠ • The operating temperature of this product is -20° to 40° C (-4° to 104° F). It does not meet the standard operating temperature for military-grade application (-55° to 125° C/-67° to 257° F), which is required to endure greater environmental variability. Operate the product appropriately and only for applications that meet the operating temperature range requirements of that grade.

Contents

Legends	3
Read Before Use	3
Tutorial Videos	3
Downloading DJI Assistant 2	3
Product Profile	8
Introduction	9
Using for the First Time	10
Activating and Charging the Batteries	10
Preparing the Aircraft	10
Preparing the Remote Controller	14
Activating the Aircraft	14
Firmware Update	14
Overview	15
Aircraft	15
Remote Controller	16
Accessory Options (Sold Separately)	20
Aircraft	21
Aircraft Profile	22
Flight Modes	22
Aircraft Power Button/Indicators	24
Aircraft Indicators	25
Aircraft Landing Gears	26
Travel Mode Switching	26
Intelligent Landing Gear	27
Return to Home	28
Smart RTH	28
Low Battery RTH	31
Failsafe RTH	32
Vision Systems and Infrared Sensing System	35
Detection Range	35
Using the Vision System	37
Flight Recorder	39
Aircraft FPV Camera	39
Aircraft Antennas	40
Aircraft RTK	40

Propellers	42
Expansion Ports	44
Intelligent Battery Charging Hub	45
Charging Hub Overview	46
Paired Charging of Batteries	47
Charging Modes	48
Using the Charging Hub	48
Charging Hub LED Indicators	49
Intelligent Battery	50
Introduction	51
Battery Features	51
Using the Battery	53
Using the Paired Batteries	53
Mounting/Removing the Battery	53
Hot Battery Replacement	54
Powering On/Off and Checking the Battery Level	54
Warming the Battery	55
Battery Storage	56
Gimbal Camera	57
Overview	58
X9-8K Air Gimbal Camera	59
Camera Specifications	59
Storing Photos and Videos	61
Camera Operation	62
Gimbal	63
Controllable Rotation Range	63
Gimbal Operation	64
Remote Controller	65
Preparing the Remote Controller	66
Mounting the WB37 Intelligent Battery	66
Mounting the Dongle	67
Using the Strap and Waist Support	67
Adjusting the Sticks	68
Adjusting the Antennas	68
Starting and Activating the Remote Controller	69

User Interface	70
Home Screen	70
Screen Gestures	70
Shortcut Settings	71
Video Transmission	72
Remote Controller LEDs and Alert	73
Charging the Remote Controller and Checking the Battery Level	74
Linking the Remote Controller and Control Stick Modes	76
Buttons Overview	79
RTH Button	79
L1/L2/L3/R1/R2/R3 Buttons	79
Button Customization and Combinations	79
Aircraft Control Button	80
Flight Mode Switch (N/S/F)	81
Calibrating the Compass	81
HDMI Settings	81
Dual Control Mode	81
DJI Professional Ecosystem	84
DJI Video Transmitter	85
DJI High-Bright Remote Monitor	85
DJI Three-Channel Follow Focus	87
DJI Master Wheels	87
Typical Application Scenarios	88
DJI Pilot 2 App	91
Homepage	92
Gimbal Camera View	96
Introduction	96
Top Bar	98
Navigation Display	99
Camera Quick Settings Panel	101
Advanced Camera Settings Panel	102
Monitoring Settings	102
Storage Settings	103
Other Settings	104
Waypoint Pro	107
Spotlight Pro	109

FPV Camera View	111
Full Screen Mode	112
Map View	112
Health Management System (HMS)	113
Flight	115
Flight Environment Requirements	116
Operating the Aircraft Responsibly	117
Flight Limits and GEO Zones	118
GEO (Geospatial Environment Online) System	118
Flight Limits	118
Flight Altitude and Distance Limits	118
GEO Zones	119
Calibrating the Compass	120
Pre-Flight Checklist	121
Auto Takeoff/Auto Return to Home	122
Starting/Stopping the Motors	122
Flight Test	123
Appendix	124
Appendix	125
Specifications	125
Firmware Update	132
Using DJI Pilot 2	132
Using DJI Assistant 2 (Inspire Series)	133
Storage and Transportation and Maintenance	134
Trolley Case	135
Using the Trolley Case for Storage	135
Trolley Case Lock	136
Troubleshooting Procedures	137
Risk and Warnings	137
Disposal	137
C3 Certification	138
FAR Remote ID Compliance Information	143
After-Sales Information	144

Product Profile

This chapter introduces the major features of the product.

Product Profile

Introduction

DJI INSPIRE™ 3 is a cinematic-grade aerial shooting system equipped with the DJI ZENMUSE™ X9-8K Air gimbal camera, which consists of the aircraft, the gimbal camera, and the remote controller using the DJI Pilot 2 app.

The aircraft integrates a multi-redundancy flight controller system, horizontal omnidirectional vision system, infrared sensing system, and night-vision flight system allowing for hovering and flying indoors as well as outdoors and automatic Return to Home while avoiding obstacles in all directions. It is integrated with a centimeter-level RTK module, which can help to provide accurate positioning of up to centimeter-level.

With the 3-axis gimbal stabilization system, the Zenmuse X9-8K Air gimbal camera supports dual native ISO and recording at up to 8K 75fps ProRes RAW or 8K 25fps CinemaDNG as well as 4K 120fps video.^[1] The DL-mount supports various DJI DL lenses.

The lightweight body and classic streamlined shape allow for sufficient power redundancy to improve flight maneuverability. And the newly designed transformational body can guarantee an unobscured gimbal camera view when flying at high speed so that the gimbal camera can move freely to record more breathtaking videos.

The DJI RC Plus remote controller features O3 Pro video transmission and transmits up to two HD liveviews from the aircraft to the remote controller. With the DJI Pilot 2 app designed for DJI Inspire 3, users can view images and data using the camera view in real time. The remote controller comes with a wide range of aircraft and gimbal controls as well as customizable buttons, which can easily control the aircraft and operate the camera.

[1] CinemaDNG and ProRes RAW formats will be available when the appropriate license is purchase and applied.

Using for the First Time

Activating and Charging the Batteries

The Intelligent Batteries and remote controller internal battery require activation before first use. The remote controller cannot be powered on before activating the internal battery.

Insert the Intelligent Batteries into the charging hub, connect the charging hub to the remote controller using the USB-C to USB-C high-speed data cable, and then connect the charging hub to a power outlet. The Intelligent Battery is activated after the charging hub is connected to the power outlet. The battery level LEDs start to flash to indicate that the remote controller internal battery is activated.

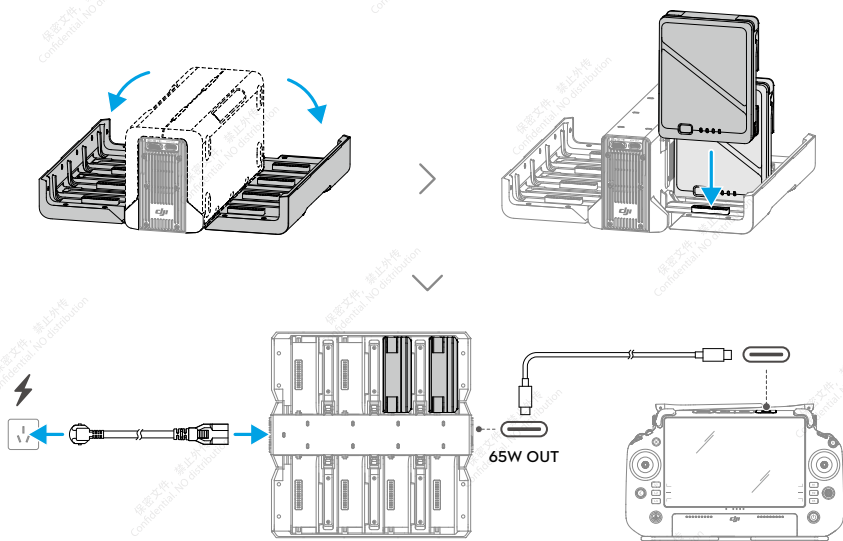

Preparing the Aircraft

1. Remove the protective covers from the aircraft battery compartment, and insert two activated Intelligent Batteries. Make sure the batteries are mounted firmly.

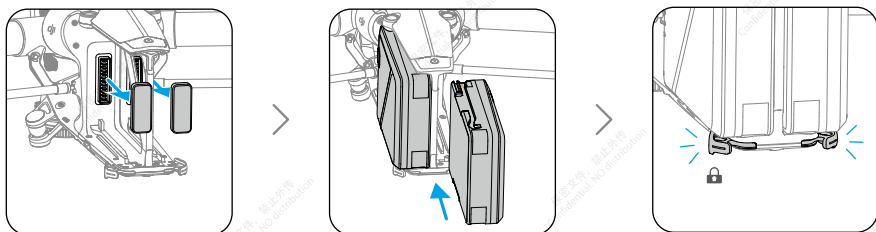

- 2 Press the power button a minimum of five times to transform the aircraft to Landing mode, and power on. At this time, the indicators of the power button light up sequentially.

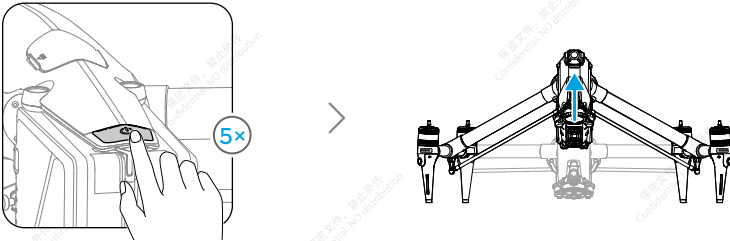

- Press, and then press and hold the power button to power on the aircraft.

3. Remove the protective covers of the lens and gimbal camera lens mount. Install the lens (sold separately) to the gimbal camera and remove the gimbal connector cover.

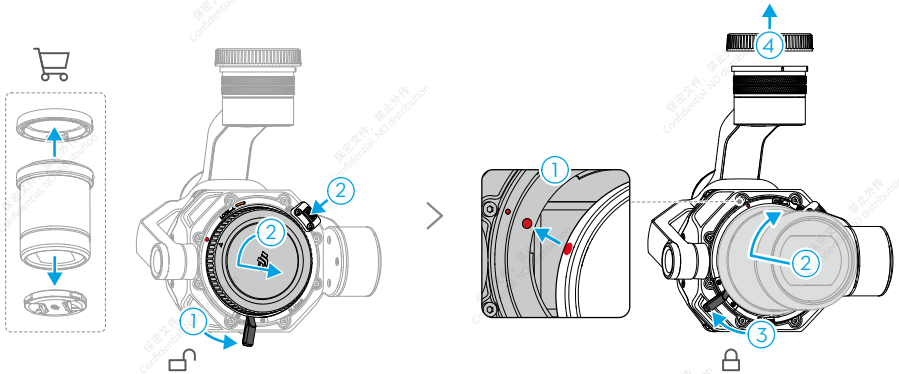

- Make sure that the lens locking lever is in the unlocked position and that both red dots on the lens mount are aligned before mounting the camera lens.
- DO NOT press the lens release button while mounting the camera lens.
- Always toggle the lens locking lever to cover the orange mark on the camera until the lever is tight and secure after mounting the camera lens. Otherwise, lens vibration may occur during flight.
- Pay attention to sand, dust, and water when disassembling the gimbal camera or replacing the lens. Make sure to operate in a dust-free environment, as dust that enters the gimbal camera lens mount or lens may cause scratches and affect use.
- Follow the instructions in this manual to properly mount the replacement supported lenses and related accessories to avoid damage caused by improper operation.
- Clean the surface of the camera lens with a soft, dry, clean cloth. DO NOT use substances containing alcohol, benzene, thinners, or other flammable substances to clean or maintain the camera.

- ⚠ • DO NOT expose the camera lens to a strong energy source such as the sun, lava, or laser beams. Otherwise, it will cause damage to camera.

4. Remove the protective cover on the aircraft and install the gimbal camera to the aircraft.

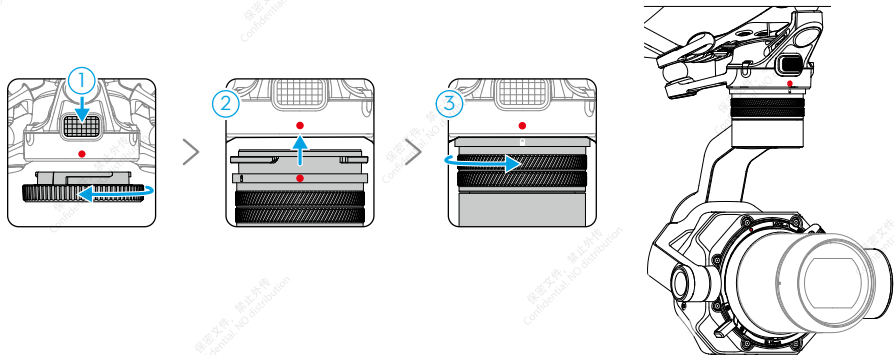

- 💡 • Make sure to hold the gimbal firmly when removing or mounting it.
- Make sure that the gimbal connector on the aircraft is correctly positioned when mounting, otherwise the gimbal camera will not mount.
- To remove the gimbal camera, hold down the gimbal camera detach button on the aircraft and rotate the gimbal camera to detach it.

- ⚠ • DO NOT disassemble the gimbal without authorization.
- Precision elements in the gimbal may be damaged by a collision or impact, which may cause the gimbal to function abnormally. Make sure to protect the gimbal from damage.
- The gimbal dampers and the connector between the gimbal and the aircraft are delicate. Keep them away from damage. Contact DJI Support or a DJI authorized dealer for further assistance if necessary. Read the maintenance manual for more information on how to replace the gimbal damper.

5. Insert the DJI PROSSD into the aircraft. The indicator on the DJI PROSSD turns on, indicating that it is correctly inserted.

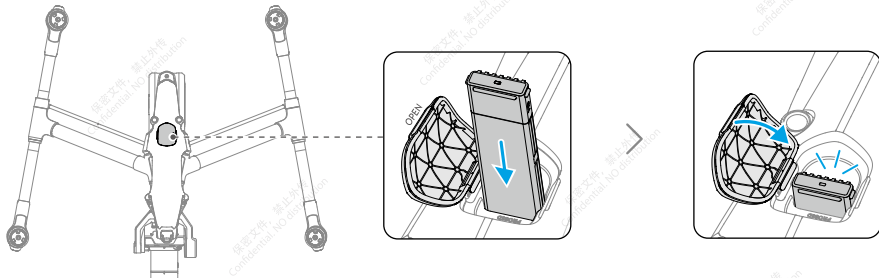

6. After aligning the propeller and the motor installation mark, respectively insert the four propellers into the motors, and then press and rotate to lock.

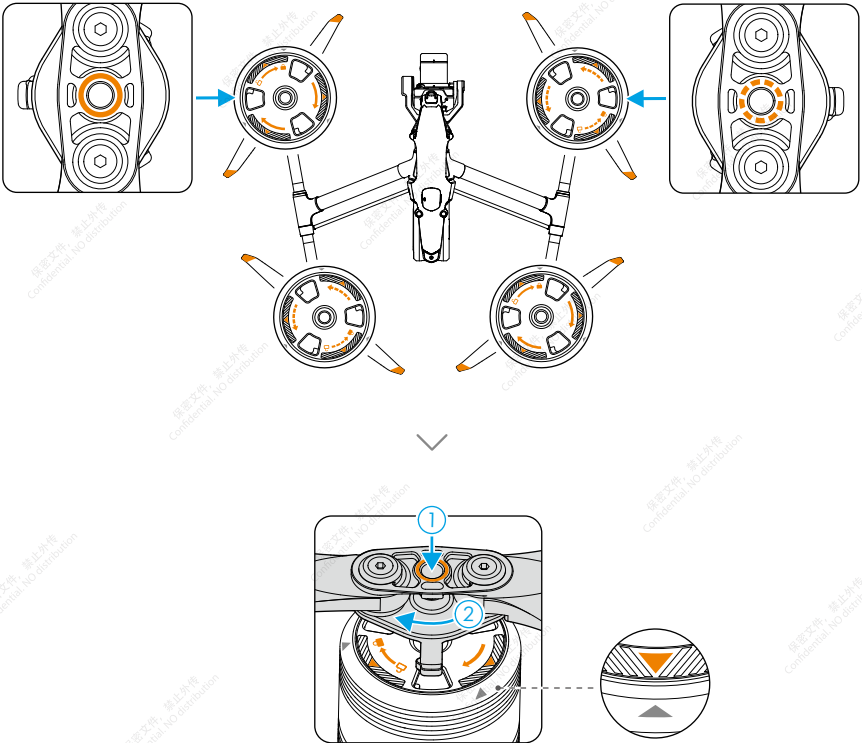

- 💡 • Make sure the quick-release propeller adapter is rotated to install in place, and the propeller adapter springs back with the top of the motor shaft.
 - Before removing the propeller, first press down the propeller adapter.
-
- ⚠️ • Be aware of the sharp edges of the propellers when examining, mounting, or removing the propellers.

Preparing the Remote Controller

The remote controller is already linked to the aircraft when it is purchased together as part of a combo.

The remote controller requires activation before first use, and an internet connection is required for activation. Press, and then press and hold the power button to power on the remote controller. Follow the on-screen prompts to activate the remote controller.

When powered off, press the power button to check the battery level.

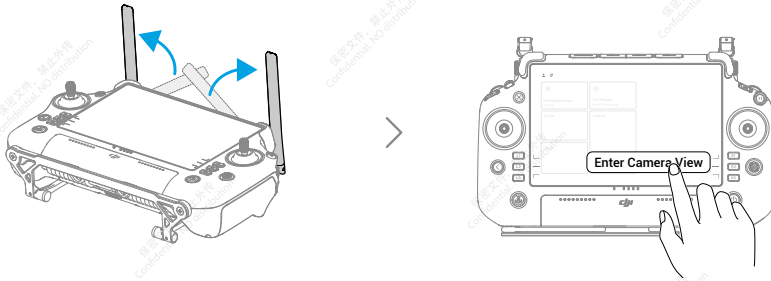

Activating the Aircraft

The aircraft requires activation before first use. After powering on the aircraft and remote controller, follow the on-screen prompts to activate the aircraft using DJI Pilot 2. An internet connection is required for activation.

Firmware Update

A prompt will appear in DJI Pilot 2 when new firmware is available. It is recommended to update the firmware whenever prompted to do so, in order to ensure the best possible user experience.

Overview

Aircraft

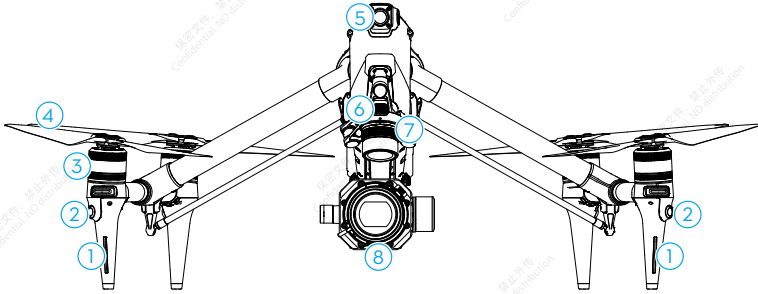

- | | |
|---|-------------------------------------|
| 1. Front LED Indicators | 5. FPV Camera |
| 2. Horizontal Omnidirectional Vision System | 6. Gimbal Release Button |
| 3. Motors | 7. Gimbal Camera Quick-Release Port |
| 4. Propellers | 8. Gimbal Camera |

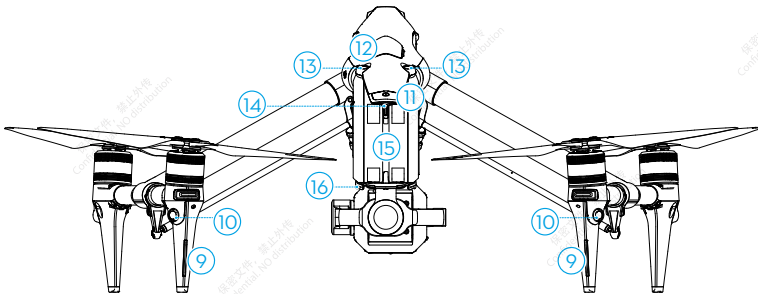

- | | |
|--|---------------------------|
| 9. Rear LED Indicators | 13. Upward Vision System |
| 10. Horizontal Omnidirectional Vision System | 14. Y-Shape LED Indicator |
| 11. Aircraft Power Button/Indicator | 15. Intelligent Batteries |
| 12. DJI PROSSD Slot | 16. Battery Release |

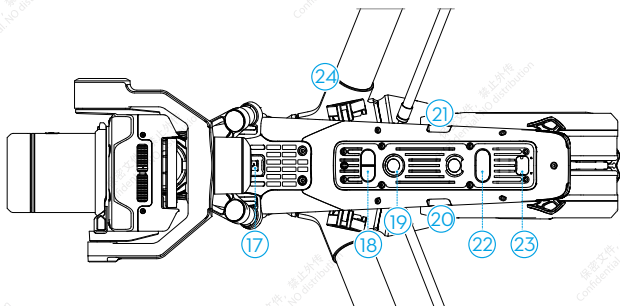

- | | |
|--------------------------------------|------------------------------|
| 17. USB-C Assistant Port | 21. Timecode Input Port |
| 18. Downward Infrared Sensing System | 22. Auxiliary Light |
| 19. Downward Vision System | 23. Expansion Port |
| 20. USB-C Port | 24. Transformation Mechanism |

Remote Controller

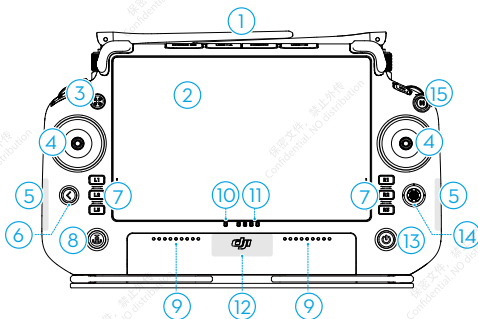

1. External RC Antennas

Transmit control and video wireless signals between the remote controller and the aircraft.

2. Touchscreen

Displays system and app views and supports up to 10 touch points. Make sure the touchscreen is clean, and completely dry before use. Otherwise, viewing and touch effects may be affected.

3. Aircraft Control Button

The aircraft control button is used to take control of the aircraft and indicate the aircraft control status. Refer to Guide on the home screen for more information.

4. Control Sticks

Control stick mode can be set in DJI Pilot 2.

5. Internal Wi-Fi Antennas

DO NOT block the Wi-Fi antennas during usage. Otherwise, the signal may be affected.

6. Back/Function Button

Press once to return to the previous screen. Press twice to return to the home screen. Use the back button and another button to activate combination buttons. Refer to Guide on the home screen for more information.

7. L1/L2/L3/R1/R2/R3 Buttons

Go to camera view in DJI Pilot 2 to view the specific functions of these buttons.

8. Return to Home (RTH) Button

Press and hold to initiate RTH. Press again to cancel RTH.

9. Microphones

DO NOT block the microphones during usage.

10. Status LEDs

Indicates the remote controller status. Refer to Remote Controller LEDs and Alert section or Guide on the home screen for more information.

11. Battery Level LEDs

Displays the current battery level of the remote controller. Refer to Remote Controller LEDs and Alert section for more information.

12. Internal GNSS Antennas

DO NOT block the internal GNSS antennas during usage. Otherwise, the positioning accuracy may be affected.

13. Power Button

Press once to check the current battery level. Press, and then press and hold for two seconds to power the remote controller on or off. When the remote controller is powered on, press once to turn the touchscreen on or off.

14. 5D Button

View the default 5D button functions in DJI Pilot 2. Refer to Guide on the home screen for more information.

15. Flight Pause Button

Press once to have the aircraft brake and hover in place (only when GNSS or Vision Systems are available).

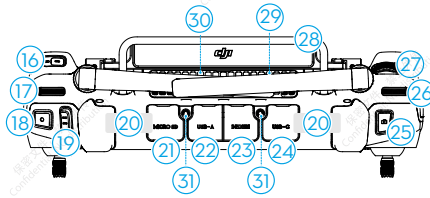

16. C3 Button

Customize functions in DJI Pilot 2.

17. Left Dial

Controls the tilt of the gimbal.

18. Record Button

Press once to start or stop recording.

19. Flight Mode Switch

Switch between different flight modes. Users can switch between the Normal, Sport, and Function modes. The Function mode can be configured in the app.

20. Internal RC Antennas

Transmit aircraft control and video wireless signals. DO NOT block the internal RC antennas during usage. Otherwise, the signal may be affected.

21. microSD Card Slot

For inserting a microSD card.

22. USB-A Port

Users can connect the remote controller to the TB51 intelligent battery charging hub to update the charging hub firmware. Users can also insert third-party devices, such as a USB flash drive or a memory card.

23. HDMI Port

For outputting HDMI signals to external monitor.

24. USB-C Port

For charging the remote controller by connecting to the charging hub.

25. Focus/Shutter Button

Press the button halfway down for autofocus, and all the way down to take a photo.

26. Right Dial

Controls the pan of the gimbal.

27. Scroll Wheel

After pressing the designated side button on the screen, turn the scroll wheel to adjust the camera parameters. Read the Camera Operation section of the Gimbal Camera for more information. It can be set in DJI Pilot 2.

- 28. Handle
- 29. Speaker
- 30. Air Vent

For heat dissipation. DO NOT block the air vent during usage.

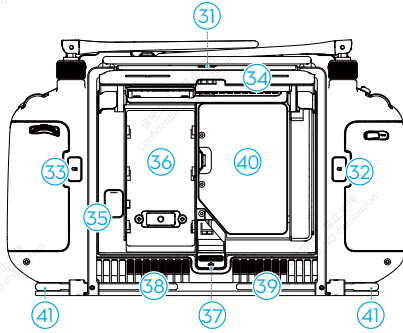

31. Reserved Mounting Holes

For mounting external devices.

32. C1 Button

Customize functions in DJI Pilot 2.

33. C2 Button

Customize functions in DJI Pilot 2.

34. Rear Cover

35. Battery Release Button

36. Battery Compartment

For installing WB37 Intelligent Battery (excluded).

37. Rear Cover Release Button

38. Alarm

39. Air Intake

For heat dissipation. DO NOT block the air intake during usage.

40. Dongle Compartment

For inserting dongle to the USB-C connector.

41. Waist Support

For connecting the remote controller strap.

Accessory Options (Sold Separately)

DJI DL Lens

DJI Zenmuse X9-8K Air gimbal camera is equipped with a DL mount supporting to install with a DJI DL lens. Read the Gimbal Camera chapter for installation and more information.

DJI Professional Ecosystem

DJI Inspire 3 can be used with other DJI products, such as DJI Video Transmitter, DJI High-Bright Remote Monitor, DJI Three-Channel Follow Focus, and DJI Master Wheels, to form a professional film ecosystem. Read the DJI Professional Ecosystem chapter for more information.

Aircraft

This chapter introduces the major features of the aircraft.

Aircraft

Aircraft Profile

The Inspire 3 aircraft mainly consists of the flight control system, communication system, vision system, image processing system, propulsion system, transformation mechanism, and power and battery system. This chapter provides a detailed introduction to the aircraft components and functions.

Flight Modes

Flight modes can be switched via the Flight Mode switch on the remote controller.

N-mode (Normal)

The aircraft utilizes GNSS and the forward, backward, lateral, upward, and downward vision systems, and infrared sensing system to locate and stabilize itself. When the GNSS signal is strong, the aircraft uses GNSS to locate and stabilize itself. When the GNSS is weak, but the lighting and other environmental conditions are sufficient, the aircraft uses the vision systems to locate and stabilize itself. When obstacle sensing is enabled and the lighting and other environment conditions are sufficient, the maximum flight speed of the aircraft will be 15 m/s and the maximum tilt angle of the aircraft will be 35°. When the GNSS signal is weak and the lighting and other environmental conditions are insufficient, the aircraft cannot hover precisely and can only maintain its altitude.

S-mode (Sport)

The aircraft utilizes the GNSS and downward vision system to hover precisely. By adjusting the gain and expo settings, the maximum flight speed of the aircraft can be increased to 26 m/s. When in S-mode, obstacle sensing in the four horizontal directions will be disabled, and the aircraft cannot detect or bypass obstacles in these directions. The upward and downward vision systems work normally to achieve the precise hover positioning.

F-mode (Function)

Function mode can be set to T-mode (Tripod mode) or A-mode (Attitude mode) in DJI Pilot 2. T-mode is based on N-mode. The flight speed is limited to allow easier control of the aircraft. Attitude mode must be used with caution.

-
-  • Obstacle sensing is disabled in S-mode, which means the aircraft cannot sense and brake to avoid obstacles automatically. Pay attention to the surrounding environment and obstacles on the route when flying the aircraft in S-mode.
- Note that when flying in S-mode, the flight speed of the aircraft will greatly increase compared with that in N-mode (Normal). The braking distance will increase significantly. When flying in a windless environment, a minimum braking distance of 55 m (180 ft) is required.
 - A minimum braking distance of 15 m (49 ft) is required in windless conditions while the aircraft is ascending and descending when in S-mode.
-

A-mode (Attitude mode)

In Attitude mode, the vision systems and some intelligent features are disabled. The aircraft cannot position itself or brake automatically in this mode and is easily affected by its surroundings, which may result in horizontal shifting. Use the remote controller to control and position the aircraft. Fly with caution.



- DO NOT switch from N-mode to either S-mode or F-mode unless you are sufficiently familiar with the aircraft behavior under each flight mode. Make sure to turn on Multiple Flight Modes in DJI Pilot 2 before switching from N-mode to other modes.
 - Avoid flying in areas where the GNSS signal is weak or in narrow and confined spaces. Otherwise, the aircraft will be forced to enter Attitude mode, leading to potential flight hazards. Land the aircraft in a safe place as soon as possible.
-

Aircraft Power Button/Indicators

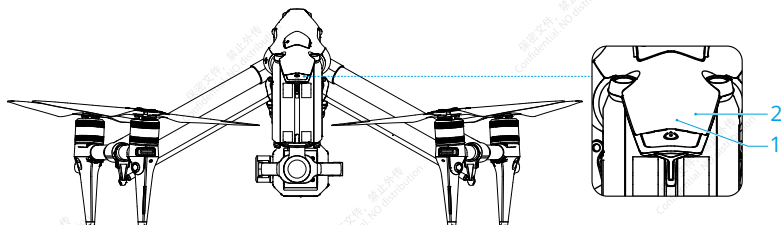

1. Power Button (after mounting the intelligent batteries):
 - a. Press the power button once to check the current aircraft battery level.
 - b. Press, and then press and hold for two seconds to power the aircraft on or off.
 - c. Press the power button a minimum of five times to unlock or enter the travel mode.

2. Indicators: display the current aircraft battery level or the aircraft status.

The Battery Level Indicators will also show the current battery level during discharging. The indicators are defined below.

█ : LED is on. ○ : LED is off. : LED is flashing.

Battery Level				
LED1	LED2	LED3	LED4	Battery Level
█	█	█	█	88%~100%
█	█	█		75%~87%
█	█	█	○	63%~74%
█	█		○	50%~62%
█	█	○	○	38%~49%
█		○	○	25%~37%
█	○	○	○	13%~24%
	○	○	○	0%~12%

Aircraft Status				
LED1	LED2	LED3	LED4	Description
				Aircraft status error. Connect to the remote controller, run DJI Pilot 2, and tap HMS to diagnose the error.
○	█		○	Aircraft firmware is updating.
				Aircraft and remote controller are linking.

Aircraft Indicators

The aircraft has front LED, rear LED, and Y-shape LED indicators.

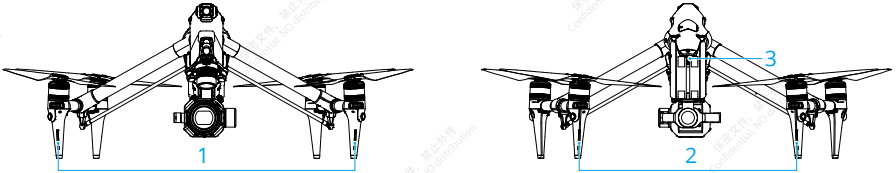





1. Front LED Indicators
2. Rear LED Indicators
3. Y-shape LED Indicator







When the aircraft is powered on but the motors are not running, the front LEDs glow solid red to display the orientation of the aircraft.

When the aircraft is powered on but the motors are not running, the rear LEDs display the status of the flight control system. Refer to the table below for more information about the aircraft status indicators.

Normal States

	Blinks red, yellow, and green alternately	Powering on and performing self-diagnostic tests
	Blinks yellow four times	Warming up
	Blinks green slowly	GNSS enabled
	Blinks green twice repeatedly	Vision systems enabled
	Blinks yellow slowly	GNSS and vision systems disabled (Attitude mode enabled)

Warning States

	Blinks yellow quickly	Remote controller signal lost
	Blinks red slowly	Low battery level, takeoff is disabled *
	Blinks red quickly	Critically low battery
	Blinks red quickly (when performing CSC)	IMU error
	Solid Red	Critical error *
	Blinks red and yellow alternately	Compass calibration required

* If the aircraft cannot takeoff while the rear indicator is blinking red slowly or solid red, connect to the remote controller, run DJI Pilot 2, and view the details.

After the motor starts, the front LEDs blink red and green alternately and the rear LEDs blink green. The green lights indicate the aircraft is a UAV and the red lights indicate the heading and position of the aircraft.

The Y-shaped LED is used to assist in indicating the direction of the aircraft rear. After the aircraft is powered on, the Y-shaped LED will display solid green.

-
- ⚠ • Lighting requirements vary depending on the region. Observe local laws and regulations.
-

Aircraft Landing Gears

The aircraft is in travel mode before delivery. Follow the steps below to transform it to landing mode before first use.

Travel Mode Switching

Place the aircraft on a flat surface (such as a table) before switching between travel mode and landing mode.

Unlocking Travel Mode: after mounting the batteries, press the power button a minimum of five times to transform the aircraft from travel mode to landing mode, and power on.

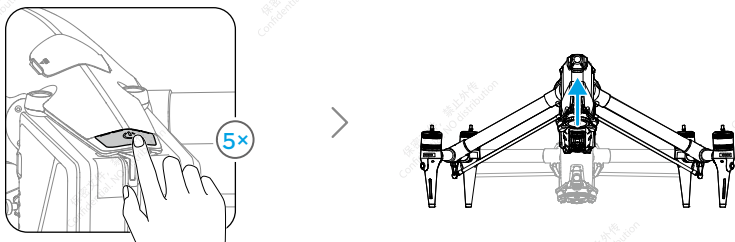

Entering Travel Mode: remove the gimbal camera with the aircraft powered on, press the power button a minimum of five times, wait for the aircraft to enter travel mode, and power off. Press the battery release before removing a battery.

-
- ⚠ • After pressing the power button a minimum of five times with the gimbal camera attached to the aircraft, the aircraft will enter travel mode once the gimbal camera is removed. The aircraft cannot transform from landing mode to travel mode with the gimbal camera attached.
- Keep your hands away from the transformation mechanism during the aircraft transformation.
-

- 💡 • For the situations that need to adjust the landing gear manually, insert the crossing-end of the included screwdriver into the small hole on the bottom of the aircraft, and slowly rotate the gear of the servo gearbox.

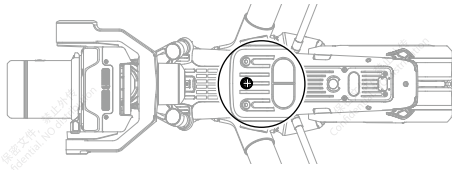

Intelligent Landing Gear

Go to the DJI Pilot 2 camera view and tap  to display the intelligent landing gear switch.

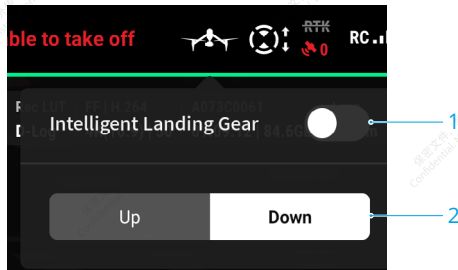

1. Intelligent Landing Gear Switch: when enabled, the aircraft will automatically raise or lower the landing gear during takeoff or landing. When disabled, it is recommended to go to the camera view and tap  > Land Gear Settings to enable Precision Landing so that downward obstacle avoidance is turned on. Once the landing gear is raised during landing, the aircraft will automatically brake at 1 m above the ground to protect the gimbal camera.
2. Landing Gear Transformation Buttons: during flight, tap the buttons to raise or lower the landing gear.



- The landing gear can also raise or lower by pressing the R1 button on the remote controller. Read the Gimbal Camera View Introduction in the DJI Pilot 2 App chapter for more details.
- The landing gear will be automatically locked when the aircraft stays on the ground, unlock it in the Landing Gear Settings in app before using the remote controller or app to operate the landing gear, if necessary.

Return to Home

Return to Home (RTH) brings the aircraft back to the last recorded Home Point when the positioning system is functioning normally. There are three types of RTH: Smart RTH, Low Battery RTH, and Failsafe RTH. The aircraft automatically flies back to the Home Point and lands when Smart RTH is initiated, the aircraft enters Low Battery RTH, or the signal between the remote controller and the aircraft is lost during flight.

	GNSS	Description
Home Point		The first location where the aircraft receives a strong to moderately strong GNSS signal (indicated by a white icon) will be recorded as the default Home Point. The Home Point can be updated before takeoff as long as the aircraft receives another strong to moderately strong GNSS signal. If the signal is weak, the Home Point will not be updated. DJI Pilot 2 will give a voice prompt when the Home Point is set.

Smart RTH

If the GNSS signal is sufficiently strong, Smart RTH can be used to bring the aircraft back to the Home Point. Smart RTH is initiated either by tapping  in DJI Pilot 2 or by pressing and holding the RTH button on the remote controller until it beeps. During the RTH process, the remote controller will emit a "beep" sound. Press the RTH button or the flight pause button on the remote controller or tap the stop icon  on the camera view in DJI Pilot 2 to exit the RTH. After exiting RTH, users will regain control of the aircraft.

Advanced RTH

Advanced RTH is enabled if the lighting is sufficient and the environment is suitable for vision systems when Smart RTH is triggered. The aircraft will automatically plan the best RTH path, which will be displayed in the DJI Pilot 2 app and will adjust according to the environment.

RTH Settings

RTH settings are available for Advanced RTH. Go to the camera view in DJI Pilot 2, tap ******* > , and then set Return to Home to Preset or Optimal.

1. Preset: when the aircraft is at a distance of 20 to 50 m from the Home Point when RTH begins, the aircraft will not ascend to the RTH Altitude and instead returns to home using the best path at the current altitude. If the aircraft is further than 50 m from the Home Point when RTH begins, the aircraft will plan the RTH path, fly to an open area while avoiding obstacles, ascend to the RTH Altitude, and return to home using the best path. When the aircraft is near the Home Point, the aircraft will descend while flying forward if the current altitude is higher than the RTH Altitude.
2. Optimal: regardless of the RTH Altitude settings, the aircraft automatically plans the optimal RTH path and adjusts the altitude according to environmental factors such as obstacles and transmission signals. The optimal RTH path means the aircraft will travel the shortest distance possible, reducing the amount of battery power used and increasing flight time.

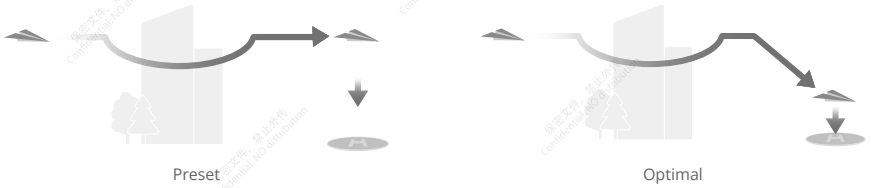

Advanced RTH Procedure

1. The Home Point is recorded.
2. Advanced RTH is triggered.
3. The aircraft brakes and hovers in place.
 - a. The aircraft lands immediately if it is less than 20 m from the Home Point when RTH begins.
 - b. If the aircraft is farther than 20 m from the Home Point when RTH begins, the aircraft will plan the best path according to the RTH settings and fly to the Home Point while avoiding obstacles and GEO zones. The aircraft front will always point in the same direction as the flight direction.
4. The aircraft will fly automatically according to the RTH settings, environment, and transmission signal during RTH.
5. The aircraft lands and the motors stop after reaching the Home Point.

Straight Line RTH

The aircraft will enter Straight Line RTH when the lighting is not sufficient and the environment is not suitable for Advanced RTH.

Straight Line RTH Procedure:

1. The Home Point is recorded.
2. Straight Line RTH is triggered.
3. The aircraft brakes and hovers in place.
 - a. If the aircraft is farther than 50 m from the Home Point when RTH begins, the aircraft first ascends to a height of 20 m (this step is skipped if the current height is higher than 20 m), then the aircraft adjusts its orientation and ascends to the preset RTH altitude and flies to the Home Point. If the current altitude is higher than the RTH altitude, the aircraft will fly to the Home Point at the current altitude.
 - b. If the aircraft is at a distance of 20 to 50 m from the Home Point when RTH begins, the aircraft first ascends to a height of 20 m (this step is skipped if the current height is higher than 20 m), then the aircraft adjusts its orientation and flies to the Home Point. If the current altitude is lower than 5 m when RTH begins, the aircraft will ascend to 5 m and fly to the Home Point.
 - c. The aircraft lands immediately if it is less than 20 m from the Home Point when RTH begins.
4. The aircraft lands and the motors stop after reaching the Home Point.



- During Advanced RTH, the aircraft will adjust the flight speed automatically to suit environmental factors such as wind speed and obstacles.
 - The aircraft cannot avoid small or fine objects such as tree branches or power lines. Fly the aircraft to an open area before using Smart RTH.
 - Set Advanced RTH as Preset if there are power lines or towers that the aircraft cannot avoid on the RTH path and make sure the RTH Altitude is set higher than all obstacles.
 - The aircraft will brake and return to home according to the latest settings if the RTH settings are changed during RTH.
 - If the max altitude is set below the current altitude during RTH, the aircraft will descend to the max altitude and return to home.
 - The RTH Altitude cannot be changed during RTH.
 - If there is a large difference in the current altitude and the RTH altitude, the amount of battery power used cannot be calculated accurately due to wind speeds at different altitudes. Pay extra attention to the battery power and warning prompts in DJI Pilot 2.
 - Advanced Smart RTH will not be available if the lighting condition and environment is not suitable for vision systems during takeoff or RTH.
 - During Advanced RTH, the aircraft will enter Straight Line RTH if the lighting condition and environment are not suitable for vision systems and the aircraft cannot avoid obstacles. An appropriate RTH altitude must be set before entering RTH.
 - When the remote controller signal is normal during Advanced RTH, the pitch stick can be used to control the flight speed, but the orientation and altitude cannot be controlled and the aircraft cannot be flown left or right. Acceleration uses more power. The aircraft cannot avoid obstacles if the flight speed exceeds the effective sensing speed. The aircraft will brake and hover in place and exit from RTH if the pitch stick is pulled all the way down. The aircraft can be controlled after the pitch stick is released.
 - When the remote controller signal is normal during Straight Line RTH, the flight speed and altitude can be controlled using the remote controller, but the orientation of the aircraft cannot be controlled and the aircraft cannot be flown left or right. The aircraft cannot avoid obstacles if the pitch stick is used to accelerate and the flight speed exceeds the effective sensing speed. When the aircraft is ascending or flying forward, push the control stick in the opposite direction to exit RTH. Release the control stick to regain control of the aircraft. If the aircraft reaches the max altitude while it is ascending during RTH, the aircraft stops and returns to the Home Point at the current altitude.
 - The aircraft will hover in place if it reaches the max altitude while it is ascending after detecting obstacles in front.
 - The aircraft will brake during Straight Line RTH when it is less than 50 m from the Home Point and detects an object.
-

Low Battery RTH

When the Intelligent Battery level is too low and there is not enough power to return home, land the aircraft as soon as possible.

To avoid unnecessary danger caused by insufficient power, the aircraft will automatically calculate if it has enough power to fly to the Home Point from its current location. A warning prompt will appear in DJI Pilot 2 when the battery level is low and only has enough power to complete an RTH flight.

The aircraft will automatically fly to the Home Point if no action is taken after a 10-second countdown. Cancel RTH by pressing the RTH button or the flight pause button on the remote controller.



If the countdown of the low battery RTH is canceled, after 60 seconds from the last countdown, once the current battery level becomes lower than the Smart RTH battery level, the app will display a countdown for 10 seconds. If RTH is canceled following the warning, the Intelligent Battery may not have enough power for the aircraft to land safely, which may lead to the aircraft crashing or being lost.

The aircraft will land automatically if the current battery level can only support the aircraft long enough to descend from its current altitude. Auto landing cannot be canceled, but the remote controller can be used to alter the horizontal movement and the speed of descent of the aircraft during landing. If there is sufficient power, the throttle stick can be used to make the aircraft ascend at a speed of 1 m/s.

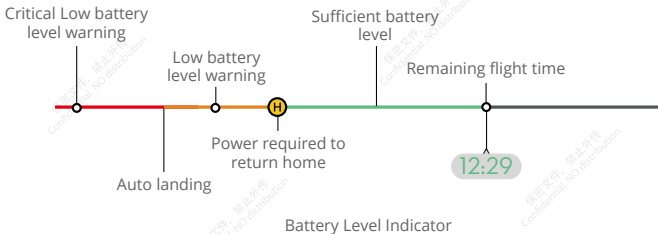
During auto landing, move the aircraft horizontally to find an appropriate place to land as soon as possible. The aircraft will fall if the user keeps pushing the throttle stick upward until the power is depleted.



Battery Level Warning	Implication	Flight
Low Battery RTH	The remaining battery level is only enough for the aircraft to fly to the Home Point safely.	If RTH is selected, the aircraft will fly to the Home Point automatically and landing protection will be enabled. Users can regain control of the aircraft and land it manually during RTH. ⚠ The warning will not appear again after choosing not to use RTH. Decide carefully and ensure flight safety.

Auto Landing	The remaining battery level is only enough for the aircraft to descend from its current altitude.	The aircraft will land automatically and landing protection will be enabled.
Estimated Remaining Flight Time	The estimated remaining flight time of the aircraft is based on its current battery level.	/
Low Battery Level Warning	Tap ●●●>  in camera view to set the low battery level threshold value.*	Long beeps will sound from the remote controller. The user can still control the aircraft.
Critical Low Battery Level Warning	Tap ●●●>  in camera view to set the critical low battery level threshold value.*	Short beeps will sound from the remote controller. The user can still control the aircraft. It is unsafe to continue flying the aircraft. Land immediately.

* The threshold value is different from that of Low Battery RTH or auto landing.

 • The colored zones and the estimated remaining flight time on the battery level indicator are automatically adjusted according to the aircraft's current location and status.

Failsafe RTH

The action of the aircraft when the remote controller signal is lost can be set to RTH, land, or hover in DJI Pilot 2. If the Home Point was successfully recorded and the compass is functioning normally, Failsafe RTH automatically activates after the remote controller signal or the command and control link is lost for more than six seconds.

When the lighting is sufficient and the vision systems are working normally, DJI Pilot 2 will display the RTH path that was generated by the aircraft before the remote controller signal was lost and return to home using Advanced RTH according to the RTH settings. The aircraft will remain in RTH even if the remote controller signal is restored. DJI Pilot 2 will update the RTH path accordingly.

When the lighting is not sufficient and the vision systems are not available, the aircraft will enter Original Route RTH.

Original Route RTH Procedure:

1. Original Route RTH is triggered.
2. The aircraft brakes and hovers in place.
 - a. If the aircraft is farther than 50 m from the Home Point, the aircraft adjusts its orientation and flies backward for 50 m on its original flight route before entering Straight Line RTH.
 - b. If the aircraft is at a distance of 20 to 50 m from the Home Point, it enters Straight Line RTH.
 - c. The aircraft lands immediately if it is less than 20 m from the Home Point when RTH begins.

3. The aircraft lands and the motors stop after reaching the Home Point.

The aircraft will enter or remain in Straight Line RTH if the remote controller signal is restored during RTH.



- The aircraft may not be able to return to the Home Point normally if the GNSS signal is weak or unavailable. The aircraft may enter Attitude mode if the GNSS signal becomes weak or unavailable after entering Failsafe RTH. The aircraft will hover in place for a while before landing.
- It is important to set a suitable RTH altitude before each flight. Launch DJI Pilot 2 and set the RTH altitude. The default RTH altitude is 100 m.
- The aircraft cannot avoid obstacles during Failsafe RTH if the vision systems are unavailable.
- GEO zones may affect the RTH. Avoid flying near GEO zones.
- The aircraft may not be able to return to a Home Point when the wind speed is too high. Fly with caution.
- Be aware of small or fine objects (such as tree branches or power lines) or transparent objects (such as water or glass) during RTH. Exit RTH and control the aircraft manually in an emergency.
- RTH may not be available in some environments even if the vision systems are working. The aircraft will exit RTH in such cases.

Landing Protection

If the user triggers RTH or auto landing using the remote controller or the app, Landing Protection will activate during Smart RTH. When the aircraft begins to land, Landing Protection is enabled.

1. During Landing Protection, the aircraft will automatically detect and carefully land on suitable ground.
2. If the ground is determined unsuitable for landing, the aircraft will hover and wait for pilot confirmation.
3. If Landing Protection is not operational, DJI Pilot 2 will display a landing prompt when the aircraft descends to 1 m from the ground. Tap confirm or push the throttle stick all the way down and hold for one second, and the aircraft will land.



- Landing protection will not work in the following circumstances:
 - a. When the downward vision system is disabled.
 - b. When the user is operating the pitch/roll/throttle stick (landing protection will be reactivated when the control stick is not in use).
 - c. When the positioning system is not functioning properly (such as position drift errors).
 - d. When the vision system needs calibrating. When the lighting is too dim for the vision system to operate.
 - e. If no valid observation data is obtained and the ground conditions cannot be detected, the aircraft will descend to 1 m above the ground and hover pending confirmation by the user to land.

Precision Landing

The aircraft automatically scans and attempts to match the terrain features below during RTH. The aircraft will land when the current terrain matches the Home Point. A prompt will appear in DJI Pilot 2 if the terrain match fails.



- Landing Protection is activated during Precision Landing.
 - The performance of Precision Landing is subject to the following conditions:
 - a. The Home Point must be recorded upon takeoff and must not be changed during flight. Otherwise, the aircraft will have no record of the terrain features of the Home Point.
 - b. During takeoff, the aircraft must ascend at least 7 m before moving horizontally.
 - c. The Home Point terrain features must remain largely unchanged.
 - d. The terrain features of the Home Point must be sufficiently distinctive. Terrain such as a snow-covered field is not suitable.
 - e. The lighting conditions must not be too light or too dark.
 - The following actions are available during Precision Landing:
 - a. Pull the throttle stick down to accelerate landing.
 - b. Move the control sticks in any direction apart from the throttle direction to stop Precision Landing. The aircraft will descend vertically after the control sticks are released, and landing protection is enabled.
-

Vision Systems and Infrared Sensing System

The aircraft is equipped with both an infrared sensing system and forward, backward, lateral, upward, and downward vision systems.

The upward and downward vision systems consist of two cameras, and the forward, backward, and lateral vision systems consist of four cameras in total.

The infrared sensing system consists of two infrared modules. The downward vision system and infrared sensing system help the aircraft maintain its current position, hover more precisely, and fly indoors or in other environments where GNSS is unavailable.

In addition, the auxiliary bottom light located on the underside of the aircraft improves visibility for the downward vision system in weak light conditions.

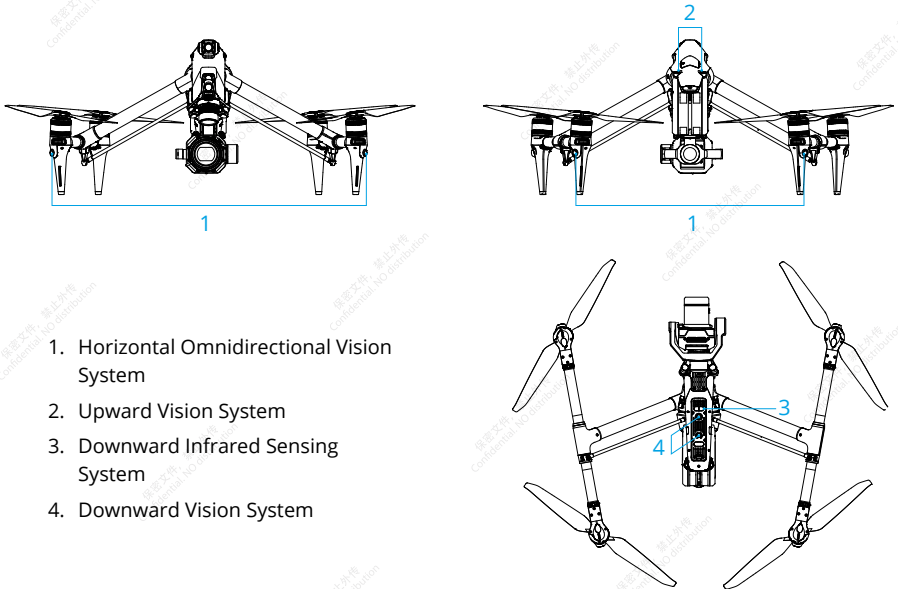

1. Horizontal Omnidirectional Vision System
2. Upward Vision System
3. Downward Infrared Sensing System
4. Downward Vision System

Detection Range

Forward Vision System

Precision Measurement Range: 1.5-48 m

Effective Sensing Speed: ≤ 15 m/s

FOV: 90° (horizontal, landing gears raised)

72° (horizontal, landing gears lowered), 103° (vertical)

Backward Vision System

Precision Measurement Range: 1.5-48 m

Effective Sensing Speed: ≤ 15 m/s

FOV: 90° (horizontal), 103° (vertical)

Lateral Vision System

Precision Measurement Range: 1.5-42 m

Effective Sensing Speed: ≤ 15 m/s

FOV: 90° (horizontal), 85° (vertical)

Upward Vision System

Precision Measurement Range: 0.2-13 m

Effective Sensing Speed: ≤ 6 m/s

FOV: 100° (front and back), 90° (left and right)

Downward Vision System

Precision Measurement Range: 0.3-18 m

Precision Measurement Range: 0.5-30 m

Effective Sensing Speed: ≤ 6 m/s

FOV (for vision obstacle avoidance): 130° (front and back), 160° (left and right)

FOV (for vision positioning or ground detection): 90° (front and back), 70° (left and right)

Landing Gear Raised

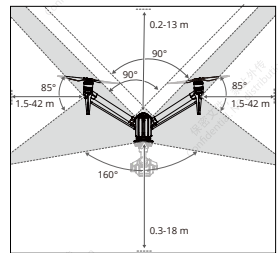
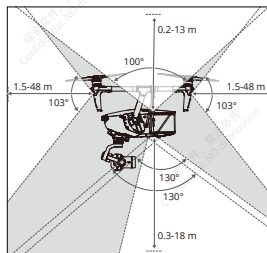
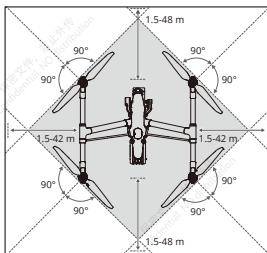

Landing Gear Lowered

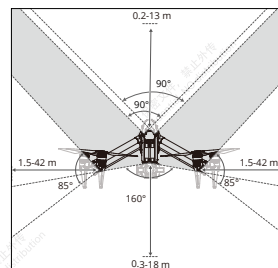
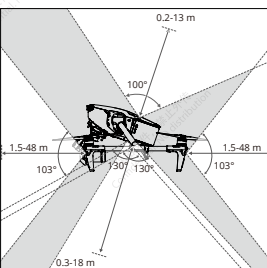
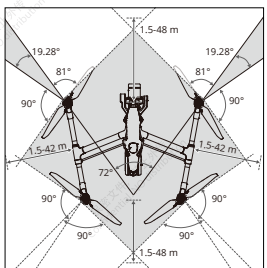

-
- ⚠ • Omnidirectional obstacle sensing is available in the horizontal direction when the landing gear is raised. When the landing gear is lowered, there are two 20° sensor blind spots at the front left and right of the aircraft that may affect obstacle sensing. See the diagram above. Fly with caution.
 - The gray area is the blind spot of the vision system, where the aircraft cannot detect objects. Fly with caution.
 - The various gimbal rotation and the lens length will change the FOV of the downward vision system, and the blind spot of the downward vision system will change accordingly. Fly with caution.
-

Using the Vision System

The positioning function of the downward vision system is applicable when GNSS signals are unavailable or weak. It is automatically enabled in N-mode or T-mode.

The horizontal omnidirectional and upward vision systems will activate automatically when the aircraft is powered on if the aircraft is in N-mode or T-mode, and Obstacle Avoidance is set to Brake in DJI Pilot 2. The aircraft can actively brake when detecting obstacles when using the horizontal omnidirectional, and upward vision systems. The horizontal omnidirectional and upward vision systems work best with adequate lighting and clearly marked or textured obstacles. Due to inertia, users must make sure to brake the aircraft within a reasonable distance.

-
- ⚠ • Pay attention to the flight environment. The vision system and infrared sensing system only work in certain scenarios and cannot replace human control and judgment. During a flight, always pay attention to the surrounding environment and the warnings in DJI Pilot 2, and be responsible for and maintain control of the aircraft at all times.
 - Obstacle Avoidance is disabled during the landing gear transformation. Fly with caution.
 - The aircraft cannot avoid moving obstacles such as people, animals, or vehicles. Fly with caution.
 - The downward vision systems work best when the aircraft is at an altitude from 0.5 to 30 m if there is no GNSS available. Extra caution is required if the altitude of the aircraft is above 30 m as the vision positioning performance may be affected.
 - The auxiliary bottom light can be set in DJI Pilot 2. If set to Auto, it is automatically enabled when the environment light is too weak. Note that the vision system performance may not be restored to the best state. Fly with caution if the GNSS signal is weak.
 - The vision system may not work properly over water. Therefore, the aircraft may not be able to actively avoid water below it when landing. It is recommended to maintain flight control at all times, make reasonable judgments based on the surrounding environment, and avoid over-relying on the downward vision system.

- The vision system cannot work properly over surfaces without clear pattern variations or where the light is too weak or too strong. The vision system cannot work properly in the following situations:
 - a. Flying near monochrome surfaces (e.g., pure black, white, red, or green) or those without clear texture or those with highly repetitive textures (e.g., small bricks of the same color).
 - b. Flying near surfaces with strong reflected light or images (e.g., water, ice, or transparent surfaces).
 - c. Flying near moving surfaces or objects (e.g., crowds of people or swaying reeds, shrubs, or grass).
 - d. Flying in an area with frequent and drastic lighting changes.
 - e. Flying near extremely dark (< 10 lux) or extremely bright (> 40,000 lux) surfaces.
 - f. Tiny obstacles (e.g., iron wiring, cables, and tree branches).
 - g. The lens is dirty (e.g., from raindrops or fingerprints).
 - h. In low-visibility environments less than 100 m (e.g., heavy fog or snow).
- Be alert when in control of the aircraft instead of relying on the obstacle avoidance function provided by the vision systems and the infrared sensing system.
- Obstacle avoidance cannot detect certain obstacles such as iron wiring, cables, tree branches, blind spots, and mirrored surfaces. Keep the aircraft within VLOS and pay close attention to the flight. Use the liveview to help operate the aircraft and manually avoid obstacles in a timely manner.
- If the aircraft is involved in a collision, it may be necessary to ship the aircraft to DJI to calibrate the vision systems. DO NOT hang or place anything in an area that will block the vision systems, infrared sensing systems, and their observation range.
- Make sure that the sensor lens is clear and free of stains. Check the following before each takeoff:
 - a. Make sure there are no stickers or any other obstructions over the glass of the infrared sensing systems and vision systems.
 - b. Use soft cloth if there is any dirt, dust, or water on the glass of the vision systems and infrared sensing system. DO NOT use any cleaning product that contains alcohol.
 - c. Contact DJI Support if there is any damage to the lenses of the infrared sensing and vision systems.
- If the aircraft attitude angle is larger than 30° or the speed exceeds 15 m/s, the infrared sensing systems cannot detect obstacles in time for the aircraft to brake and hover at a safe distance.
- Be aware of the blind spots (marked gray) of the vision systems and infrared sensing systems. Aircraft cannot sense obstacles that are out of the detection range. The infrared sensor observation range is from 0.1 to 10 m.
- DO NOT obstruct the infrared sensing system.

Flight Recorder

Flight data including flight telemetry, aircraft status information, and other parameters are automatically saved to the internal data storage of the aircraft. The data can be accessed using DJI Assistant 2 (Inspire Series). Follow the instructions in the DJI Assistant 2 to export the flight record.

Aircraft FPV Camera

DJI Inspire 3 aircraft is equipped with an FPV camera using a 1/1.8" sensor, which can optimize images in poor lighting conditions at night. Using the 161° FOV, it helps the pilot to have better visibility of the flight environment and fly safely.

When the landing gear is raised and the aircraft is flying horizontally, the controllable range of the gimbal pitch is from -60° to $+45^{\circ}$. When the landing gear is lowered or the aircraft is tilted, the controllable range of the gimbal pitch will be reduced due to the influence of the angle of the propeller blade.

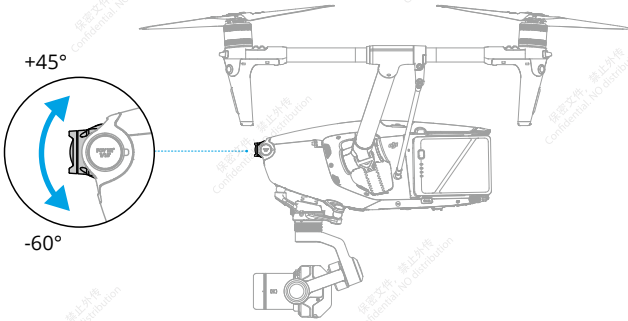

Aircraft Antennas

DO NOT cover or block any antenna during usage to avoid affecting communication or positioning performance.

1. Internal O3 Pro Video Transmission Antennas
2. Internal DJI AirSense Antennas
3. Internal RTK Antennas

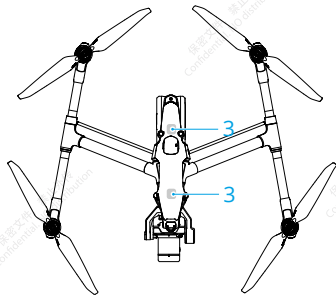
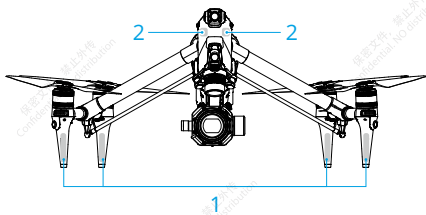

Aircraft RTK

RTK Module Introduction

The built-in RTK module of the aircraft supports three types of global positioning systems including BeiDou, GPS and Galileo, which can withstand strong magnetic interference from metal structures and high-voltage lines, ensuring safe and stable flight. When used with a D-RTK 2 High Precision GNSS Mobile Station (sold separately) or a Custom Network RTK service, more accurate positioning data can be obtained. *

* Both D-RTK 2 High Precision GNSS Mobile Station and D-RTK 2 High Precision GNSS Mobile Station for Matrice Series are supported.



- The RTK positioning needs to be in an environment with good GNSS signal (outdoors in an open area without obstacles) to ensure high-precision positioning. The RTK solution is fixed to converge to centimeter-level accuracy.
- RTK positioning accuracy is affected by the atmospheric situation, and it cannot be fixed when ionosphere flickering or large errors occur.

Enabling/Disabling RTK

Ensure that the RTK function is enabled and the RTK service type is correctly set (D-RTK 2 Mobile Station or Custom Network RTK) before each use. Otherwise, RTK cannot be used for positioning. Go to the camera view in the DJI Pilot 2 app, tap **...** > **RTK** to check the settings. Make sure to disable the RTK function if not in use. Otherwise, the aircraft will not be able to take off when there is no differential data.



- RTK positioning can be enabled and disabled during flight. Remember to select an RTK service type first.
- Switching the RTK service type is not supported during flight.
- If the RTK positioning function is enabled when using Waypoint Pro, the same RTK service type must be used for the same flight route type to avoid positioning deviation.
- If the RTK service type is D-RTK 2 Mobile Station, make sure that the location accuracy of the base station is up to centimeter level, and configure the location coordinates of the D-RTK 2 Mobile Station.

DJI D-RTK 2 Mobile Station

1. Refer to the D-RTK 2 High Precision GNSS Mobile Station User Guide (available from <https://www.dji.com/inspire-3/downloads>) to set up the D-RTK 2 Mobile Station and link the aircraft and the station. Power on the D-RTK 2 Mobile Station and switch to the Broadcast mode of Inspire 3.
2. In the RTK settings in the app, select D-RTK 2 Mobile Station as the RTK service type, connect to the mobile station by following the on-screen instructions, and wait for the system to search for satellites. In the RTK settings, when the status of the aircraft positioning in the status table shows FIX, it indicates that the aircraft has obtained and used differential data from Network RTK.
3. D-RTK 2 Mobile Station communication distance: 12 km (NCC/FCC), 6 km (SRRC/CE/MIC).
4. The D-RTK 2 Mobile Station can only provide relatively high-precision location services. If absolute location accuracy is required, it is necessary to calibrate the absolute location of the mobile station and ensure the installation accuracy of the mobile station.

Custom Network RTK

To use Custom Network RTK, make sure that the remote controller has a Wi-Fi connection. Custom Network RTK can be used to replace the D-RTK 2 Mobile Station. Connect the Custom Network RTK account to the designated NTRIP server to send and receive differential data. Keep the remote controller turned on and connected to the internet when using this function.

1. Make sure that the remote controller is connected to the aircraft and the internet.
2. Go to the camera view in the DJI Pilot 2 app, tap **•••** > **RTK**. Select Custom Network RTK as the RTK service type and fill in the required information, and then tap Save.
3. Wait to connect to the NTRIP server. In the RTK settings, when the status of the aircraft positioning in the status table shows FIX, it indicates that the aircraft has obtained and used differential data from Custom Network RTK.

Propellers

Read the Using for the First Time section for propeller installation information.

DJI Inspire 3 aircraft supports both the 1671 Foldable Quick-Release Propellers and the 1676 Foldable Quick-Release Propellers for High Altitude (sold separately). * Refer to the diagram below to choose the appropriate propellers according to the aircraft weight (includes gimbal camera, two batteries, lens, PROSSD, and propellers) and the expected maximum flight altitude.

The service ceiling is the theoretical maximum altitude that the aircraft can fly at normally, on the condition that the wind speed does not exceed 14 m/s when flying and 12 m/s when taking off or landing. The aircraft braking and acceleration capabilities will be reduced when flying near the service ceiling. Use the Foldable Quick-Release Propellers for High Altitude when flying at altitudes higher than 3,000 m (9,842.5 ft) above sea level.

* Not available in some countries and regions.

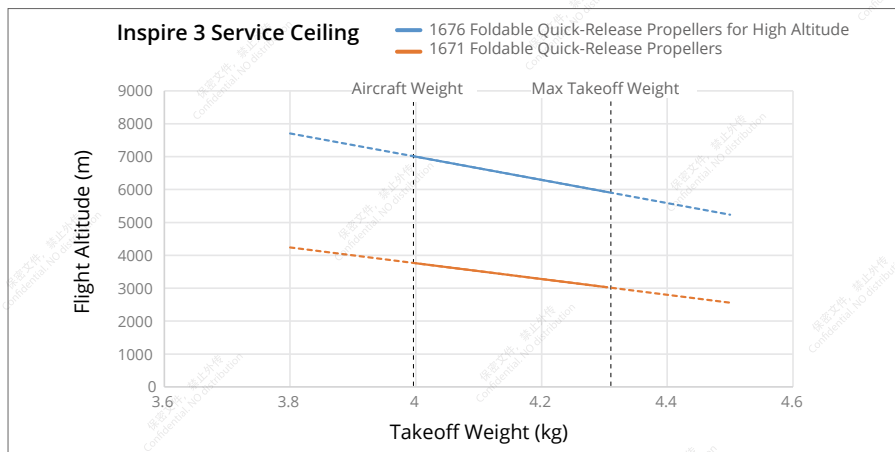

When attached with certain payloads and either the Foldable Quick-Release or the Foldable Quick-Release Propellers for High Altitude, the weight of the aircraft varies and the recommended takeoff and flying altitude also varies. The following typical data was tested in an environment with a gentle breeze and are for reference only.

Takeoff weight (kg)	Using the Foldable Quick-Release Propellers			Using the Foldable Quick-Release Propellers for High Altitude		
	Minimum takeoff altitude (m)	Maximum takeoff altitude (m)	Maximum Service Ceiling (m)	Minimum takeoff altitude (m)	Maximum takeoff altitude (m)	Maximum Service Ceiling (m)
4	0	3200	3700	3000	6500	7000
4.3	0	2500	3000	1900	5400	5900

Maximum flight altitude after takeoff is according to the national regulations.

-
- ⚠ • Compared with the ordinary propellers, if high altitude propellers are used to fly at altitudes lower than 3,000 m (9,842.5 ft) above sea level, the motor temperature rises higher, which may reduce motor life or even damage it. Therefore, use high altitude propellers only at the recommended altitude or under suitable working conditions.
- Only use official DJI propellers. DO NOT mix propeller types.
 - Purchase additional propellers if necessary.
 - Make sure that the propellers and motors are installed securely, and are unfolded before each flight.
 - Make sure that all propellers are in good condition before each flight. Make sure that all propellers are in good condition before each flight. DO NOT use aged, chipped, or broken propellers. Power off the aircraft before examining or replacing any propellers.
 - Regularly check the wear of the propeller adapter jaws. If the wear thickness of the propeller adapter jaws exceeds 0.5 mm (about 1/4 of the original thickness), it must be replaced before use. It is recommended to check the propellers once a month.
 - To avoid injury, stay away from rotating propellers or motors.
 - Wipe the propellers dry before each flight where the surrounding temperature is approximately 0° C (32° F) to avoid the propellers from being frozen. Make sure the propellers DO NOT have any ice on them before and after each flight. Remove any ice found on the propellers before flight. Fly with caution. Return to home and land the aircraft as soon as possible if a motor overload warning prompt appears in the app.
 - After use, make sure to store the propellers in strict accordance with the requirements. Failure to store the propellers correctly may result in damage to the trolley case or deformation of the propellers. Read the Trolley Case section for the propellers storage information.
-

Expansion Ports

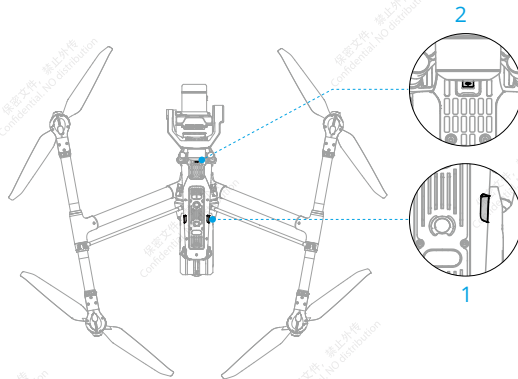

1. Timecode Input Port
2. USB-C Assistant Port

Timecode Input Port

Use a time code synchronizer with a 3.5mm audio jack (sold separately). Follow the steps below to synchronize the time code of the camera.

1. Power on the remote controller and the aircraft.
2. Go to the DJI Pilot 2 camera view, tap **...** > **PRO** > Camera Advanced Settings panel, set the timecode running mode to Free and the mode to Jam Sync.
3. Make sure that the timecode synchronizer and the camera parameters (counting mode and project frame rate) are the same.
4. Insert the timecode synchronizer into the timecode input port on the bottom of the aircraft.
5. When the EXT icon is displayed on the timecode in the app, the synchronization is successful.

USB-C Assistant Port

Connect the USB-C assistant port on the aircraft to a computer, and run DJI Assistant 2 to update the aircraft firmware. When connecting, make sure that there is no interference between the data cable and the gimbal camera rotation, especially the rotation of the gimbal pan.

Intelligent Battery Charging Hub

This chapter introduces the features of Intelligent Battery Charging Hub.

Intelligent Battery Charging Hub

Charging Hub Overview

The DJI TB51 Intelligent Battery Charging Hub features eight TB51 battery ports and one USB-C charging port. It can charge two TB51 batteries and one DJI RC Plus simultaneously.

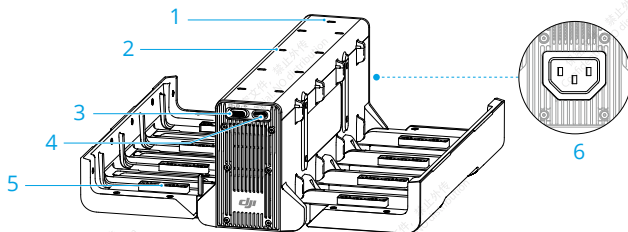

- | | |
|------------------------------|------------------------|
| 1. System Status LED | 4. USB-C Charging Port |
| 2. Charging Port Status LEDs | 5. TB51 Battery Port |
| 3. Charging Mode Switch | 6. Power Port |

Warnings

- Keep liquids away from the inside of the charging hub.
- DO NOT block the air vent of the charging hub during charging. Make sure the vent is well-ventilated and able to dissipate heat.
- The charging hub is only compatible with the TB51 battery. DO NOT use the charging hub with any other battery models.
- Place the charging hub on a flat and stable surface when in use. Make sure the device is properly insulated to prevent fire hazards.
- DO NOT attempt to touch the metal terminals on the battery port of the charging hub. Clean the metal terminals with a clean, dry cloth if there is any noticeable buildup when powered off.
- Carefully insert the battery after aligning the battery and the charging hub ports to avoid battery damage.
- Keep your fingers away from the cover connection point when opening the charging hub to avoid injury.

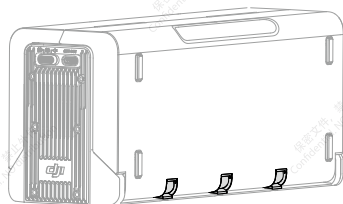

Paired Charging of Batteries

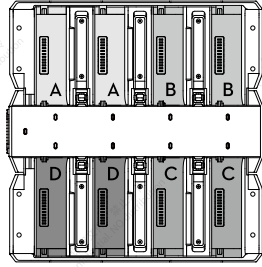

The charging hub will prioritize paired battery ports and charge the batteries according to the diagram. There are four pairs in the sequence of A, B, C, and D.

- Where there are multiple battery pairs, the pair with the highest power will be charged first. (Figure a)
- Between paired and singular batteries, paired batteries will be charged first. (Figure b)
- If none of the batteries are paired, the two batteries with the highest power will be charged first. (Figure c)

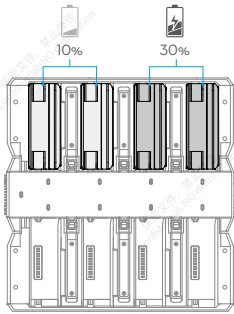

Figure a

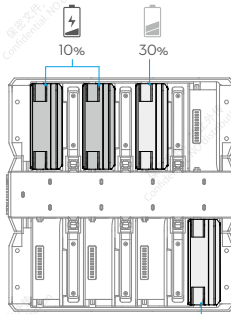

Figure b

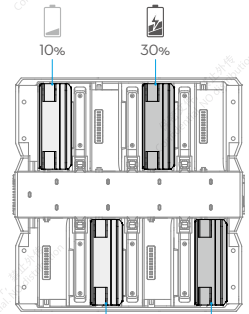

Figure c

⚡ Battery that will charge first.



- When the power of the paired batteries is not the same, the charging hub will charge the one with less power first.

Charging Modes

Toggle the charging mode switch to select from three types of charging modes.

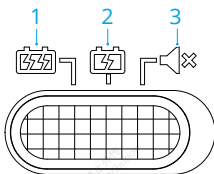

1. **Fast Mode:** each battery pair is charged to 90% in sequence, then to 100% together. It takes approximate 35 minutes to charge one battery pair to 90%, and approximate 160 minutes to charge four battery pairs to 100%.
2. **Standard Mode:** each battery pair is charged to 100% in sequence. It takes approximate 55 minutes to charge one battery pair to 100%.
3. **Silent Mode:** each battery pair is charged to 100% in sequence at a slower rate. It takes approximate 80 minutes to charge one battery pair to 100%.



- In silent mode, if the temperature is high or the air vent is blocked, the fan noise may still be loud in order to meet the charging and heat dissipation requirements.

Using the Charging Hub

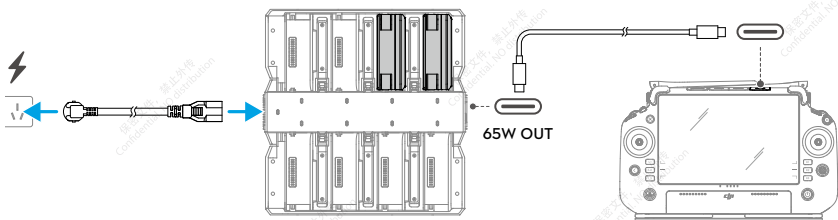









1. Open the charging hub, insert the batteries, and toggle the switch to select a charging mode.
2. Connect the charging hub to a power outlet using an AC cable to charge the batteries. Connect the USB-C port of the charging hub to the DJI RC Plus remote controller to charge the remote controller.
3. Remove the batteries from the charging hub when charging is complete and then disconnect the AC cable.



- When the temperature of a battery is below 10° C (50° F), the charging hub will automatically warm up to 18° C (64.4° F) before charging.
- The charging hub cannot charge the batteries when the battery temperature is above 45° C (113° F). During charging, the charging hub will stop charging the batteries if the battery temperature exceeds 50° C (122° F).

Charging Hub LED Indicators

LED Indicator	Description	
Charging Status		
 —	Solid green	Charging complete (in Fast Mode, batteries are charged to 90%, and fully charged after all the LEDs are solid green)
	Blinks green	Charging, while the flashing speed indicates the charging speed
 —	Solid yellow	Waiting to charge
	Blinks yellow	Battery warming up/cooling down
 —	Solid red	Charging port error *
	Blinks red	Re-insert the battery after cleaning the battery charging port
System Status		
 —	Solid green	Working normally
	Blinks yellow	Firmware updating
 —	Solid red	System error *

* Connect to the remote controller, run DJI Pilot 2, and tap HMS to diagnose the error.

Intelligent Battery

This chapter introduces the features of Intelligent Battery.

Intelligent Battery

Introduction

The TB51 Intelligent Battery is equipped with high-energy battery cells and uses an advanced battery management system to power the aircraft. Only use a DJI-approved charging device to charge the Intelligent Battery. The firmware for the Intelligent Battery is included in the aircraft firmware. Make sure the firmware of all intelligent batteries is updated to the latest version.

Battery Features

The Intelligent Battery has the following features:

1. **Battery Level Display:** the battery level LEDs display the current battery level.
2. **Battery Self-discharge:** will be triggered if the battery level is higher than 60%. Discharging the battery level to 60% can extend battery life.
3. **Battery Cell Balanced:** the voltage of the battery cells are automatically balanced to avoid overcharge or over-discharge.
4. **Overcharge Protection:** the battery stops charging automatically once fully charged.
5. **Temperature Detection:** prevents any damage, the battery only charges when the temperature is between -20° to 45° C (-4° to 113° F).
6. **Overcurrent Protection:** the battery stops charging if an excess current is detected.
7. **Over-Discharge Protection:** ensures flight safety and allow users to have as much time as possible to deal with emergencies, over-discharge protection is disabled to allow continuous output. Pay attention to the remaining battery level during flight and land or Return to Home immediately when prompted to do so in the app. Otherwise, the battery may be dangerously over-discharged. Charging an over-discharged battery may be a fire hazard. To prevent this, the battery will be locked and can no longer be charged or used. When the battery is not used in flight, over-discharge protection will be enabled once the battery level is lower than 5% to avoid battery damage.
8. **Short Circuit Protection:** the power supply is automatically cut off if a short circuit is detected.
9. **Battery Cell Damage Protection:** the app will display a warning prompt when a damaged battery cell is detected.
10. **Hibernation Mode:** the battery will be in Hibernation mode when not in use to save power. The battery will enter Deep Hibernation mode once the power is too low. At this time, the battery LEDs will not function after pressing the battery level button. Insert the battery into the charging hub to charge for activation.
11. **Communication:** information about the voltage, capacity, and current of the battery is transmitted to the aircraft.
12. **Warming up:** ensures the battery operates normally at a low temperature. Refer to the Warming the Battery section for more information.

- ⚠️ • Refer to the user manual, safety guidelines, and battery labels before use. Users shall take full responsibility for all operations and usage.
 - If only one battery is usable after takeoff, land the aircraft promptly and replace the battery.
 - Use batteries provided by DJI. DO NOT use other batteries.
 - DO NOT drop or damage the battery. DO NOT place heavy objects on the battery or the charging hub.
-

Using the Battery

Using the Paired Batteries

Charge and discharge the two batteries together to optimize flight performance and maximize battery life. After the batteries are inserted and the aircraft is powered on and there is a huge difference between their battery life, the app will display a prompt alerting the user. In this case, it is recommended to replace the batteries with similar performance before use.

Before use, the two batteries can be marked with a battery pairing sticker. The recommended area to place the sticker is shown in the diagram below.

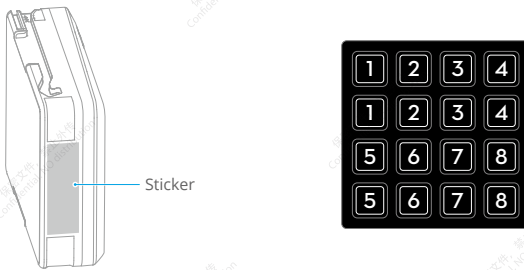

-
- ⚠ • DO NOT attach the sticker in other places, so as not to affect the installation and use of the battery.
-

Mounting/Removing the Battery

Read the Using for the First Time section for the battery installation information.

After use, toggle the battery release to unlock and remove the battery from the battery compartment.

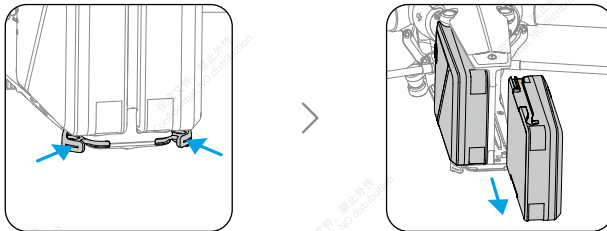

-
- 💡 • Always use a clean, dry cloth when cleaning the battery terminals. Otherwise, this may cause poor contact, resulting in energy loss or failure to charge.
-

Powering On/Off and Checking the Battery Level

Install the batteries in the aircraft before powering on or off.

Power on/off: press the power button, then press and hold for two seconds. The indicator can show current battery level after the aircraft is powered on. The indicator turns off after the aircraft is powered off.

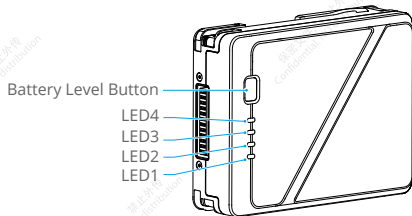
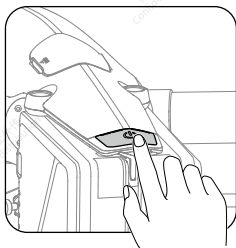

Press the battery level button to check the current battery level when the power supply is off. After powering on, check the current battery level in the top bar of the app.

The Battery Level Indicators will also show the current battery level during discharging. The indicators are defined below.

█ : LED is on.
 : LED is off.
 : LED is flashing.

LED1	LED2	LED3	LED4	Battery Level
█	█	█	█	88%~100%
█	█	█		75%~87%
█	█	█	○	63%~74%
█	█		○	50%~62%
█	█	○	○	38%~49%
█		○	○	25%~37%
█	○	○	○	13%~24%
	○	○	○	0%~12%

• Regularly check the battery level and battery cycle counts. The battery is rated for 200 cycles. It is not recommended to continue to use afterward.

Hot Battery Replacement

After landing, the aircraft does not have to be powered off for replacement of its batteries. First, insert a fully charged battery and wait for three seconds before inserting another battery.

Warming the Battery

The battery has a built-in self-heating feature for when operating in low-temperature conditions:

1. When the battery temperature is lower than 18° C (64.4° F), self-heating starts once the battery is inserted into the aircraft and powered on.
2. If the battery is not inserted into the aircraft, press and hold the battery level button for five seconds to initiate self-heating. The battery will continue to keep warm with a temperature between 18° and 20° C (64.4° and 68° F) for approximately 30 minutes. Press and hold the battery level button for five seconds to stop self-heating.
3. If the battery is at a temperature below 10° C (50° F), the charging hub will warm up the battery once it is inserted in the powered-on charging hub.
4. When the battery is warming up and staying warm the battery level LEDs will blink as follows.

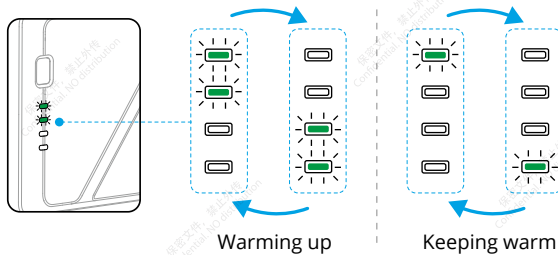

- At a temperature below 10° C (50° F), battery resistance increases and voltage decreases significantly, which in turn reduces battery capacity and performance. Make sure that the battery is fully charged and the cell voltage is 4.4 V before use.
- When the DJI Pilot 2 app shows a critically low battery level warning, it is recommended to stop flying immediately and land the aircraft in an appropriate place. During auto landing, users can still use the remote controller to control aircraft orientation and push the throttle stick to lift the aircraft.
- In extremely cold temperatures, the battery temperature may not be high enough for it to operate, even after warming up. In such scenarios, increase the insulation of the battery.
- To ensure optimal performance, keep the temperature of the batteries above 18° C (64.4° F) before flight.
- In low temperatures, the preheating period may be longer. It is recommended to insulate the batteries in advance to shorten the preheating period.

Battery Storage

1. It is recommended to store the battery separately in a dry environment at room temperature of approximately 25° C (77° F). DO NOT insert the battery into the aircraft or the charging hub for storage.
2. Battery self-discharge will be triggered if the battery level is higher than 60%. Discharging the battery level to 60% can extend battery life. The battery self-discharge strategy is shown below.

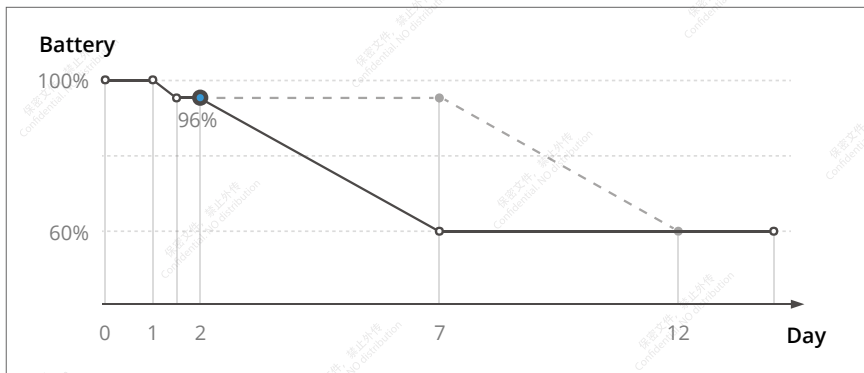

3. Storing batteries at proper levels can extend battery life. It is recommended to store the battery at 60% (the battery level LEDs display two solid LEDs and one blinking).

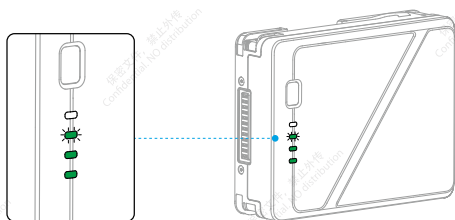

Battery Level	Max Storage Period (Day)
0%	20
5%	40
10%	60
20%	120
40%	200
60%	280

- The battery may be damaged once it exceeds the maximum storage period. The battery should no longer be used.
- The actual maximum storage period will vary slightly due to the batteries being part of different production batches and stored in different environment.

Gimbal Camera

This chapter introduces the features of gimbal camera.

Gimbal Camera

Overview

Read the Using for the First Time section for the lens and gimbal installation information.

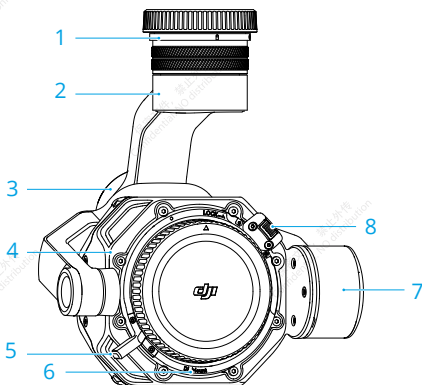

- | | |
|--|--|
| 1. Gimbal Camera Quick-Release Port | 5. Lens Locking Lever |
| Remove the protective cap before mounting onto the aircraft. | 6. Lens Mount |
| 2. Pan Motor | Attach the lens after removing the lens cap. |
| For controlling the pan axis. | 7. Tilt Motor |
| 3. Roll Motor | For controlling the tilt axis. |
| For controlling the roll axis. | 8. Lens Release Button |
| 4. Camera | |

 • The Zenmuse X9-8K Air gimbal camera supports DL-mount lenses. The descriptions and diagrams in this document are using the DJI DL lens as an example. Refer to the DJI DL Lens User Guide for more information.

X9-8K Air Gimbal Camera

The X9-8K Air camera supports recording at up to 8K 75fps ProRes RAW video and capturing 44MP photos. The camera has 12+ stops of dynamic range when recording at above 30fps video and dual native ISO of 320/1600, and 14+ stops of dynamic range when recording at 30fps video or below and dual native ISO of 800/4000.

Camera Specifications

Recording Specifications

Refer to [Recording Specifications](#) in the Specifications section for more information.

EI Grayscale

EI800 (native)

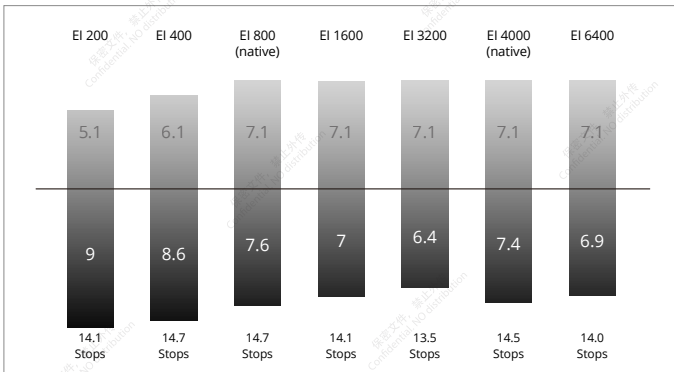

EI320 (native)

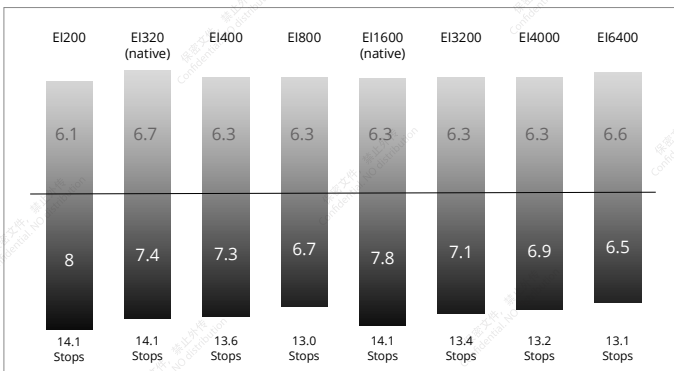

Image Sensor Resolution

CinemaDNG Full Frame 8.1K 17:9 - 8192x4320
CinemaDNG Full Frame 8K 16:9 - 7680x4320
CinemaDNG Full Frame 4.1K 17:9 - 4096x2160
CinemaDNG Full Frame 4K 16:9 - 3840x2160
CinemaDNG Super 35 5.5K 17:9 - 5568x2952
CinemaDNG Super 35 5.2K 16:9 - 5248x2952
Apple ProRes RAW Full Frame 8.1K 17:9 - 8192x4320
Apple ProRes RAW Full Frame 8K 16:9 - 7680x4320
Apple ProRes RAW Full Frame 8K 2.39:1 - 8192x3424
Apple ProRes RAW Full Frame 4.1K 17:9 - 4096x2160
Apple ProRes RAW Full Frame 4K 16:9 - 3840x2160
Apple ProRes RAW Super 35 5.5K 17:9 - 5568x2952
Apple ProRes RAW Super 35 5.2K 16:9 - 5248x2952
Apple ProRes 422HQ Full Frame 8.1K 17:9 - 8192x4320
Apple ProRes 422HQ Full Frame 8K 16:9 - 7680x4320
Apple ProRes 422HQ Full Frame 4.1K 17:9 - 4096x2160
Apple ProRes 422HQ Full Frame 4K 16:9 - 3840x2160
Apple ProRes 422HQ Super 35 4K 17:9 - 4096x2160
Apple ProRes 422HQ Super 35 4K 16:9 - 3840x2160
H.264 Full Frame 4.1K 17:9 - 4096x2160
H.264 Full Frame 4K 16:9 - 3840x2160
H.264 Super 35 4.1K 17:9 - 4096x2160
H.264 Super 35 4K 16:9 - 3840x2160

Image Sensor Size

CinemaDNG Full Frame 8.1K 17:9 - 36x19 mm
CinemaDNG Full Frame 8K 16:9 - 33.8x19 mm
CinemaDNG Full Frame 4.1K 17:9 - 36x19 mm
CinemaDNG Full Frame 4K 16:9 - 33.8x19 mm
CinemaDNG Super 35 5.5K 17:9 - 24.5x12.98 mm
CinemaDNG Super 35 5.2K 16:9 - 23.1x12.98 mm
Apple ProRes RAW Full Frame 8.1K 17:9 - 36x19 mm
Apple ProRes RAW Full Frame 8K 16:9 - 33.8x19 mm
Apple ProRes RAW Full Frame 8K 2.39:1 - 36x15.06 mm
Apple ProRes RAW Full Frame 4.1K 17:9 - 36x19 mm
Apple ProRes RAW Full Frame 4K 16:9 - 33.8x19 mm

Apple ProRes RAW Super 35 5.5K 17:9 - 24.5×12.98 mm
Apple ProRes RAW Super 35 5.2K 16:9 - 23.1×12.98 mm
Apple ProRes 422HQ Full Frame 8.1K 17:9 - 36×19 mm
Apple ProRes 422HQ Full Frame 8K 16:9 - 33.8×19 mm
Apple ProRes 422HQ Full Frame 4.1K 17:9 - 36×19 mm
Apple ProRes 422HQ Full Frame 4K 16:9 - 33.8×19 mm
Apple ProRes 422HQ Super 35 4K 17:9 - 24.5×12.98 mm
Apple ProRes 422HQ Super 35 4K 16:9 - 23.1×12.98 mm
H.264 Full Frame 4.1K 17:9 - 36×19 mm
H.264 Full Frame 4K 16:9 - 33.8×19 mm
H.264 Super 35 4.1K 17:9 - 24.5×12.98 mm
H.264 Super 35 4K 16:9 - 23.1×12.98 mm

Storing Photos and Videos

Read the Using for the First Time section for the DJI PROSSD installation information.

The included DJI PROSSD 1TB supports internal recording of the highest format and the footage can be read in the computer directly through the provided USB-C to USB-C high-speed data cable. No card reader is required.

DJI PROSSD Use Notes

- To ensure stability and reliability during recording, DJI Inspire 3 does not support third-party SSDs.
- To format the DJI PROSSD, insert the DJI PROSSD into the aircraft, and format it in the app.
- To ensure high-standard recording performance, it is not recommended to write data to the DJI PROSSD using a third-party device (such as computers or iPads). If there is any writing operation in these ways, it is recommended to format it through the aircraft before use.
- It is recommended to format the DJI PROSSD before recording videos and taking photos. Before formatting, make sure to export the existing material on the DJI PROSSD.
- DO NOT remove the DJI PROSSD or power off the aircraft when initiating or formatting the DJI PROSSD, or during video recording.
- Make sure to export photos and videos from the DJI PROSSD at a temperature ranging from -10° to 40° C (14° to 104° F).
- Store the DJI PROSSD with the environment temperature ranging from -40° to 80° C (-40° to 176° F).
- Note that the capacity of DJI PROSSD is 1 TB while the actual capacity is 935 GB.
- DO NOT cover the metal surface of the DJI PROSSD (with stickers) to ensure heat dissipation.

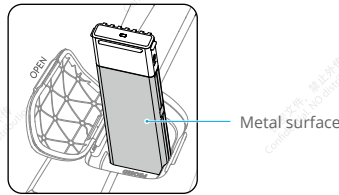

Camera Operation

Controlling the Camera with the Remote Controller

The following buttons and scroll wheel on the remote controller can be used to control the camera remotely.

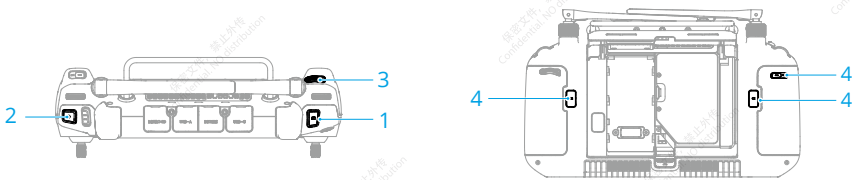

1. Focus/Shutter Button

Press halfway down to auto-focus and press all the way down to take a photo. The photo mode can be set in DJI Pilot 2.

2. Record Button

Press once to start or stop recording.

3. Scroll Wheel

After being enabled by the buttons on the side of the screen, the camera parameters can be adjusted by turning the scroll wheel. Default settings are:

- a. Press the L1 button to enable the scroll wheel to adjust the EI or ISO.
- b. Press the L2 button to enable the scroll wheel to adjust the Shutter.
- c. Press the L3 button to enable the scroll wheel to adjust the Iris.

4. C1/C2/C3 Buttons (customizable)

Enter the camera view in DJI Pilot 2, tap **•••** > to select Customize RC Buttons. Set the functions of the C1, C2, and C3 buttons for quick and easy control of the camera.



• Make sure to power off the aircraft correctly. Otherwise, the camera parameters will not be saved and any recorded videos may be affected. DJI is not responsible for any loss caused by an image or video recorded in a way that is not machine-readable.



• DO NOT store the gimbal camera near a heat source such as a heater.
 • DO NOT allow the camera to come into contact with, or become immersed in, water or other liquids. Wipe the camera dry with a soft, absorbent cloth if it gets wet.

Controlling the Camera with DJI Pilot 2

For information about how to control the camera in DJI Pilot 2, refer to the Gimbal Camera View section in the DJI Pilot 2 App chapter.

Gimbal

Controllable Rotation Range

The 3-axis gimbal stabilizes the camera, allowing the user to capture clear and steady images and videos when in flight. Refer to the figure below for the tilt, pan, and roll range of the gimbal.

Tilt: -115° to $+100^{\circ}$ (landing gear lowered); -140° to 75° (landing gear raised)

Roll: $\pm 20^{\circ}$

Pan: $\pm 300^{\circ}$

Controllable rotation range when landing gear lowered

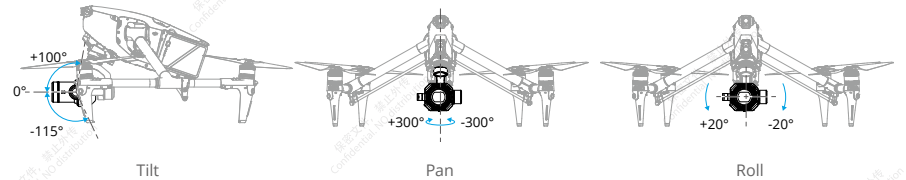

Controllable rotation range when landing gear raised

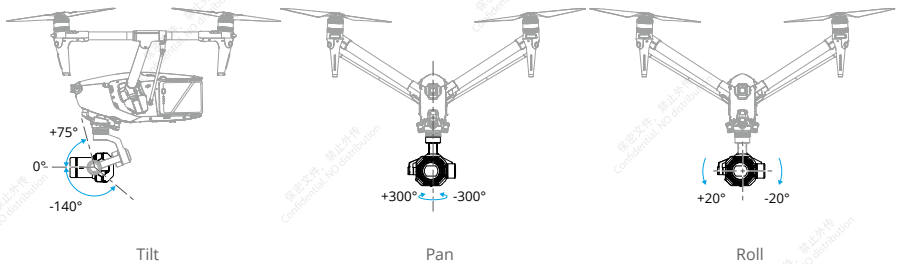

- The controllable rotation range of gimbal tilt is -90° to $+30^{\circ}$ if the gimbal tilt limit extension is disabled in the app.

Gimbal Operation

Controlling the Gimbal with the Remote Controller

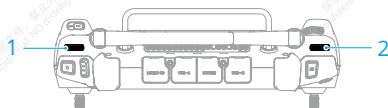

1. Left Dial

The left dial controls the gimbal tilt. Dial left, the gimbal will tilt downward. Dial right, the gimbal will tilt upward.

2. Right Dial

The right dial controls the gimbal pan. Dial left, the gimbal pan will rotate to the left. Dial right, the gimbal pan will rotate to the right.

Gimbal Mode

The gimbal can work in two modes for different shooting needs.

	<p>Follow Mode</p>	<p>When the aircraft rotates horizontally, the gimbal rotates accordingly with the angle between the gimbal pan and the aircraft heading unchanged.</p>
	<p>Free Mode</p>	<p>When the aircraft rotates horizontally, the gimbal orientation does not follow the rotation of the aircraft.</p>

- ⚠ • Make sure that there is nothing obstructing the gimbal. DO NOT tap or knock the gimbal after the aircraft is powered on. Launch the aircraft from open and flat ground to protect the gimbal during takeoff.

Remote Controller

This chapter introduces the features of Remote Controller.

Remote Controller

Preparing the Remote Controller

Mounting the WB37 Intelligent Battery

A WB37 Intelligent Battery (excluded) can be mounted onto the remote controller in the following steps.

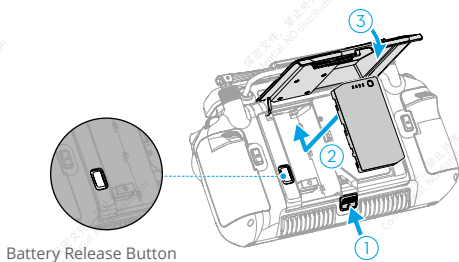

1. Push the rear cover release button to the end to open the rear cover.
2. Insert the WB37 battery into the battery compartment and push it to the top. There will be a clicking sound to indicate the battery is installed firmly.
3. Close the rear cover.

- To remove the WB37 battery, press and hold the battery release button and push the battery downward.
- Refer to the WB37 Intelligent Battery Safety Guidelines for more information.

WB37 Intelligent Battery Specifications

Capacity	4920 mAh
Voltage	7.6 V
Battery Type	Li-ion
Energy	37.39 Wh
Chemical System	LiCoO2

Mounting the Dongle

A Dongle (excluded) can be mounted onto the remote controller in the following steps.

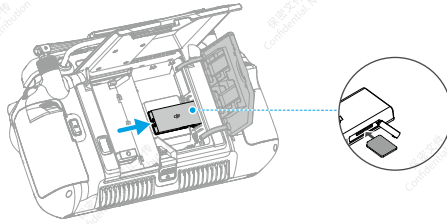

1. Push the rear cover release button to the end to open the rear cover. Remove the screws to open the dongle compartment.
2. Insert the dongle into the USB-C connector. Close the dongle compartment.
3. Attach the dongle compartment with the screws. Close the rear cover.

Using the Strap and Waist Support

A strap can be mounted onto the waist support by following the steps below.

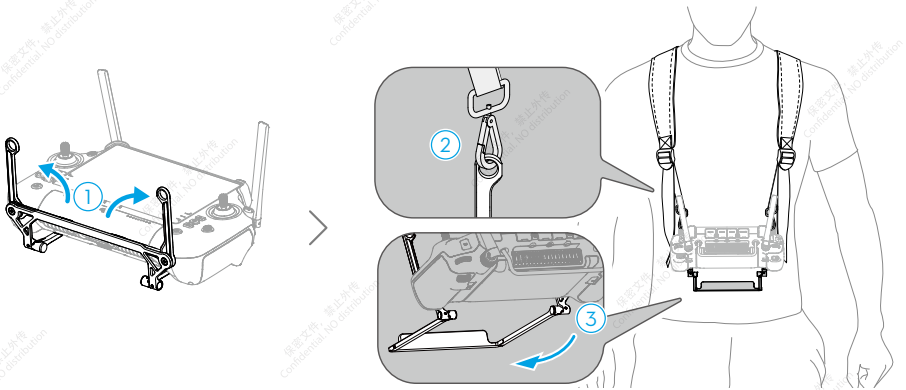

1. Unfold the two handles.
2. Wear the strap, and attach the strap hooks to the handle holes.
3. Unfold the waist support.



• After use, hold the remote controller with one hand, unlock the strap hooks with the other hand to remove the remote controller, and then take off the strap.

Adjusting the Antennas

Lift and adjust the antennas. The strength of the remote controller signal is affected by the position of the antennas.

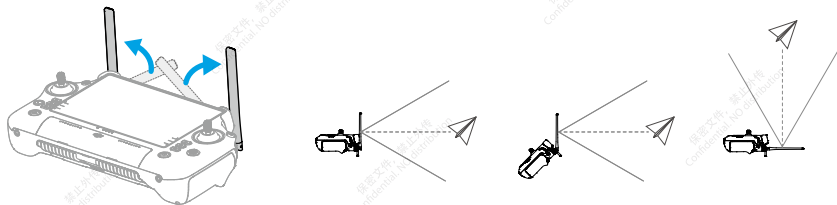

Adjust the direction of the external RC antennas and make sure their flat side is facing the aircraft, so that the controller and aircraft are within the optimal transmission zone.

- ⚠ • DO NOT overstretch the antennas to avoid damage. Contact DJI Support to repair the remote controller if the antennas are damaged. A damaged antenna will greatly decrease performance of the remote controller and might affect flight safety.
- During flight, DO NOT use other 2.4 GHz, 5.1 GHz or 5.8 GHz communication devices in the same frequency band at the same time, so as not to interfere with the communication signal of the remote controller. Such as enable the mobile phone Wi-Fi. If the remote controller must be connected to Wi-Fi during the flight, view the signal strength information of HD settings in the app. Set the Wi-Fi frequency to the frequency band with the most interference (it is recommended to set the Wi-Fi frequency to the 2.4 GHz band as it may have the most interference).
- A prompt will appear in DJI Pilot 2 if the transmission signal is weak during flight. Adjust the antennas to make sure that the aircraft is in the optimal transmission range.

Adjusting the Sticks

Adjust the sticks to a suitable position as shown in the diagram according to personal habit.

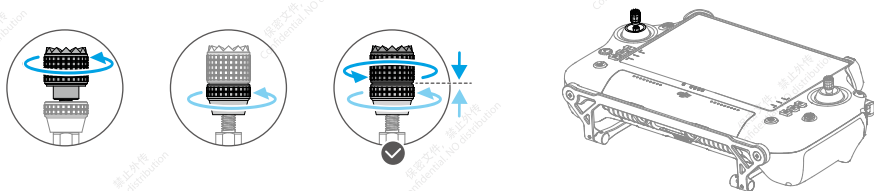

Starting and Activating the Remote Controller

Powering On/Off

Press once and then press and hold for two seconds to power the remote controller on or off.

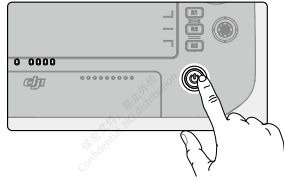

Activating the Remote Controller

 **The remote controller needs to be activated before first use. Make sure the remote controller has access to the internet during activation.**

Follow the steps below to activate the remote controller:

1. Power on the remote controller. Select a language option and tap Next. Read the Terms of Use and Privacy Policy carefully and tap Agree, then select your country/region.
2. Connect to a Wi-Fi network to access the internet. Then set the time zone, date, and time.
3. If you have a DJI account, log in with your password. If you are a new user, create a DJI account and log in.
4. After logging in, tap Activate on the activation interface.
5. A prompt will appear on the screen, indicating that the remote controller is activated.
6. After activating the remote controller, choose if you would like to join the DJI Product Improvement Project. Join this project to help DJI better understand your needs.

-  • Check the internet connection if the activation fails. Make sure internet access is available and try activating the remote controller again. Contact DJI Support if the activation fails multiple times.

User Interface

Home Screen

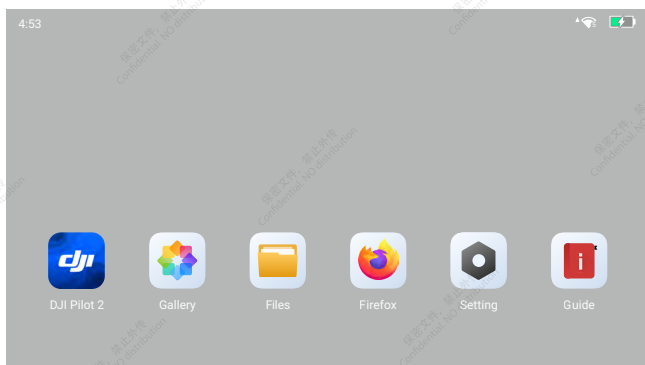

After powering on the remote controller, Time, Wi-Fi Signal, Battery Level, and applications will be display on the home screen.

Screen Gestures

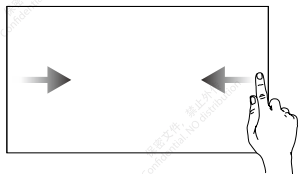

Return to the previous screen: Slide from the left or right to the center of the screen.

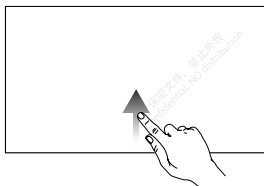

Return to the home screen: slide up from the bottom.

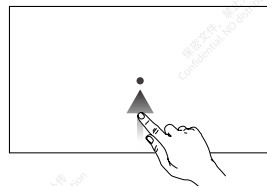

Access recently opened apps: slide up from the bottom and hold.

Shortcut Settings

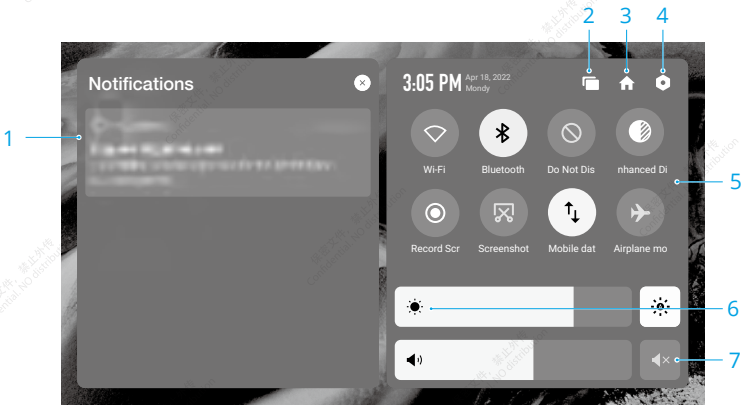

1. Notifications

View system or app notifications.

2. Recent

Tap  to view and switch to recently opened apps.

3. Home

Tap  to return to the home screen.

4. System Settings

Tap  to access system settings.

5. Shortcuts

 Tap to enable or disable Wi-Fi. Tap and hold to enter settings and connect to or add a Wi-Fi network.

 Tap to enable or disable Bluetooth. Tap and hold to open settings and connect with nearby Bluetooth devices.

 Tap to enable Do Not Disturb mode. In this mode, system prompts will be disabled.

 Display enhancement. Once enabled, the display brightness is enhanced to assist in shooting. However, there are differences between the source and display effect, while the source photo or video taken by the aircraft is not affected.



 Tap to start screen recording.

 Tap to screenshot the screen.

 Tap to turn mobile data on or off. Tap and hold to set mobile data and diagnose network connection status.

 Tap to enable Airplane mode. Wi-Fi, Bluetooth, and mobile data will be disabled.

6. Adjust Brightness

Slide the bar to adjust brightness. Tap  to adjust to auto brightness mode. Tap  or slide the bar to switch to manual brightness mode.

7. Adjust Volume

Slide the bar to adjust volume and tap  to mute. Note that after muting, all sounds of the remote controller will be completely disabled, including related alarms sounds. Please turn on mute with caution.

Video Transmission



Using a Single Remote Controller

The DJI Inspire 3 aircraft uses O3 Pro video transmission technology, which supports two simultaneous HD video transmissions. For the FPV camera, the video transmission resolution is 1080p, and the default frame rate is 60fps. For the gimbal camera, the video transmission resolution can be up to 4K with the frame rate of up to 30fps, and the frame rate can be up to 60fps if using the 1080p resolution.

-
-  • The 4K resolution video transmission of DJI Inspire 3 can only be enabled when the recording frame rate is not higher than 30fps.
 - The video transmission resolution does not support automatic adjustment. Since the 4K resolution video transmission is highly dependent on the video transmission bit rate, when the video transmission bit rate is lower than 10Mbps, it is recommended to manually adjust the resolution to 1080p.
 - When the communication quality is poor, the frame rate of the FPV camera video transmission and the gimbal camera will automatically adjust so as to improve the display quality. After the communication quality improves, the frame rate will automatically adjust to the default frame rate.
 - In order to ensure flight safety, when the communication quality is poor, priority will be given to video transmission of the FPV camera.
-

Using Dual Remote Controllers

When using dual remote controllers, the aircraft will continuously and automatically calculate the communication quality between the two remote controllers and the aircraft, automatically adjust the bit rate of the video transmission to ensure that both remote controllers can well receive the signal.

-
-  • The maximum transmission distance when using dual remote controllers is reduced by 20% compared to the transmission of a single remote controller.
 -  • When using dual remote controllers, make sure that the antennas of both remote controllers are pointing to the aircraft (refer to the Adjusting the Antennas section for details), and there is no obstruction between each remote controller and the aircraft. Otherwise, the one with the poor signal may impair the communication quality of the other.
-

Remote Controller LEDs and Alert

Remote Controller LEDs

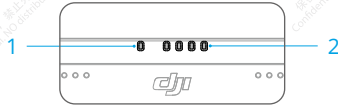

1. Status LEDs

The status LED indicates the status of the remote controller, the aircraft, and the link between them.

Blinking Patterns	Descriptions
Solid red	Disconnected with aircraft
Blinking red	Low aircraft battery level
Solid green	Connected with aircraft
Blinking blue	The remote controller is linking to an aircraft
Solid yellow	Firmware update failed
Blinking yellow	Low remote controller battery level
Blinking cyan	Control sticks not centered

2. Battery Level LEDs

The battery level LEDs indicate the battery level of the remote controller.

Battery Level LEDs				Battery Level
				88%~100%
				75%~87%
				63%~74%
				50%~62%
				38%~49%
				25%~37%
				13%~24%
				0%~12%

Remote Controller Alert

The remote controller vibrates or beeps twice to indicate an error or warning. For detailed information, see the real-time prompts on the touchscreen or in DJI Pilot 2. Swipe down from the top of the screen to open Shortcut Settings and turn on Mute mode to disable all voice alerts.

Any voice prompts and alerts will be disabled in Mute mode, including alerts during RTH and low battery alerts for the remote controller or aircraft. Use with caution.

Charging the Remote Controller and Checking the Battery Level

Charging the Remote Controller

Read the Using the Charging Hub section for more information. It takes approximately 2 hours to fully charge the remote controller internal battery.

- ☀️ • It is recommended to use the charging hub for charging. Otherwise, use a certified USB-C charger with a maximum rated power of 65 W and maximum voltage of 20 V such as the DJI 65W Portable Charger.
- Fully discharge and charge the remote controller every three months. The battery depletes when stored for an extended period.
- If a WB37 battery is installed in the remote controller, the WB37 battery will be charged at the same time.

- ⚠️ • The remote controller cannot be powered on before activating the internal battery.
- Make sure to use the included USB-C to USB-C high-speed data cable for optimal charging.

Charging Options

- The internal battery of the remote controller can be charged with a charging device or the inserted external WB37 battery. It takes approximately two hours to fully charge the internal battery with a charging device. The internal battery can be charged up to 50% with the external battery. Charging with the external battery is not possible after the remote controller is powered off.
- Duration for fully charging a WB37 battery with 0% power:
 - When mounted on the remote controller and the internal battery level is 0%, it takes approximately 2 hours while fully charging the internal battery.
 - When mounted on the remote controller and the internal battery level is 100%, it takes approximately 1 hour and 10 minutes.

- ☀️ • The charging time may vary with the ambient temperature.

Charging Mechanism

- When the remote controller is connected with both a charging device and an external battery, the remote controller will be powered by the charging device.
- When the external battery is mounted and the remote controller is not connected with a charging device, the remote controller will be powered by the external battery. When the external battery is depleted, the remote controller will be powered by the internal battery.

Checking the Battery Level

Checking the Internal Battery Level

Press the power button once to check the current battery level.

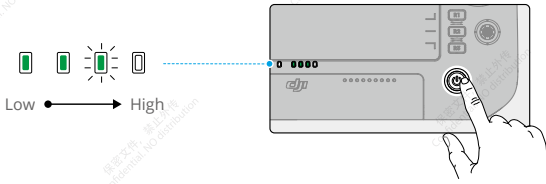

Checking the External Battery Level

Press the button on the external battery, and the LEDs will indicate the current battery level of the external battery.

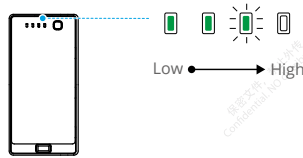

The battery level LEDs indicate the battery level of the WB37 battery.

Battery Level LEDs				Battery Level
				88%~100%
				75%~87%
				63%~74%
				50%~62%
				38%~49%
				25%~37%
				13%~24%
				0%~12%



- Alternatively, go to the home screen of the remote controller and check the battery levels of both the internal and external batteries on the status bar.

Linking the Remote Controller and Control Stick Modes

Linking the Remote Controller

The remote controller is already linked to the aircraft when it is purchased together as part of a combo. Otherwise, follow the steps below to link the remote controller and the aircraft after activation.

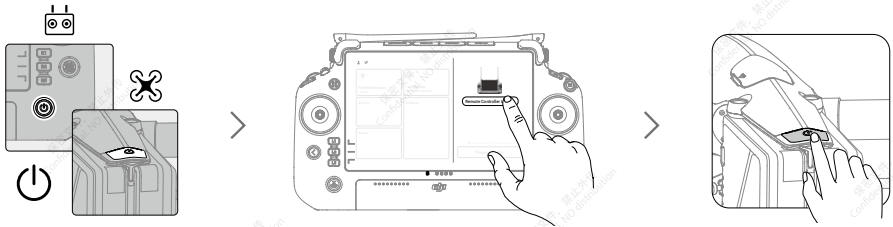

1. Power on the aircraft and the remote controller.
2. Run DJI Pilot 2 and tap Link Remote Controller to link. The status LED of the remote controller will blink blue, and the remote controller will beep during linking.
3. Press and hold the power button on the aircraft for at least five seconds. The aircraft power indicator will blink and will beep twice to indicate linking has started. When linking is successful, the aircraft rear indicators will blink green while the remote controller will beep twice, and the remote controller status LEDs will turn solid green.



• Make sure the remote controller is within 50 cm (1.6 ft) of the aircraft during linking.

Control Stick Modes

The control sticks can be operated in Mode 1, Mode 2, or Mode 3, as shown below. The default control stick mode is Mode 2. In this manual, Mode 2 is used as an example to illustrate how to use the control sticks.

Mode 1

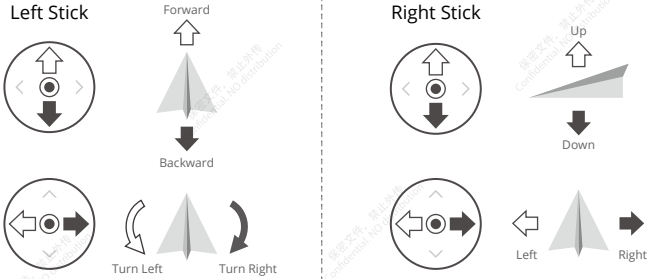

Mode 2

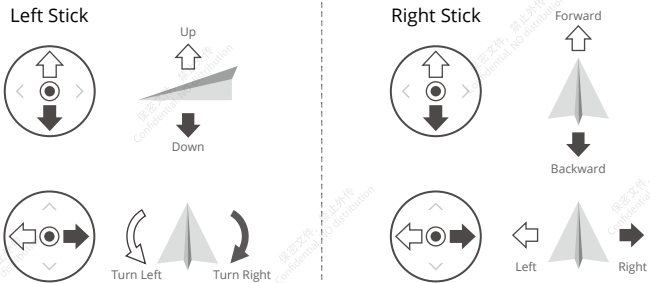



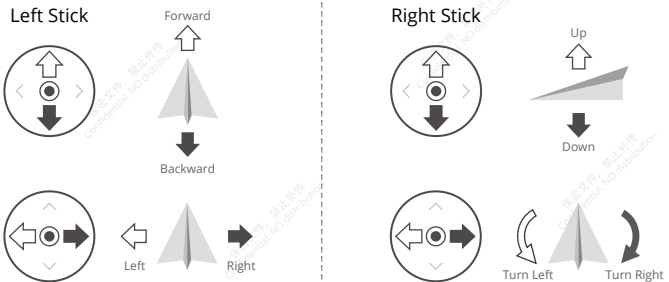



Mode 3

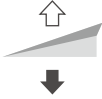

💡 Center position: control sticks are centered.

Moving the control stick: control sticks are pushed away from the center.

Remote Controller (Mode 2)	Aircraft	Remarks
		<p>Moving the left stick up or down (throttle stick) changes the aircraft's altitude. Push the stick up to ascend and down to descend. The more the stick is pushed away from the center position, the faster the aircraft will change altitude. Push the stick gently to prevent sudden and unexpected changes in altitude.</p>
		<p>Moving the left stick to the left or right (pan stick) controls the orientation of the aircraft. Push the stick left to rotate the aircraft counter-clockwise and right to rotate the aircraft clockwise. The more the stick is pushed away from the center position, the faster the aircraft will rotate.</p>
		<p>Moving the right stick up and down (pitch stick) changes the aircraft's pitch. Push the stick up to fly forward and down to fly backward. The more the stick is pushed away from the center position, the faster the aircraft will move.</p>
		<p>Moving the right stick to the left or right (roll stick) changes the aircraft's roll. Push the stick left to fly left and right to fly right. The more the stick is pushed away from the center position, the faster the aircraft will move.</p>

- ⚠️ • Keep the remote controller away from magnetic materials such as magnets and loudspeaker boxes to avoid magnetic interference.
- To avoid damage to the control sticks, it is recommended that the remote controller be stored in the trolley case when being carried or transported.

Buttons Overview

RTH Button

Press and hold the RTH button until the remote controller beeps twice to start RTH. The aircraft will fly to the last updated Home Point. Press the button again to cancel RTH and regain control of the aircraft.

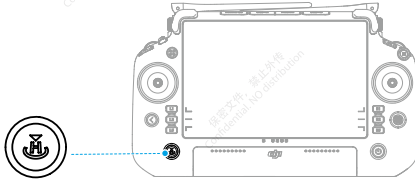

- ⚠ In Dual Control mode, the users cannot start or cancel RTH using the RTH button on the remote controller that does not have aircraft control.

L1/L2/L3/R1/R2/R3 Buttons

Find the descriptions of these button functions next to the L1/L2/L3/R1/R2/R3 buttons after running DJI Pilot 2. Tap **•••** > > Customize RC Buttons to hide the description of the buttons on both sides of the screen.

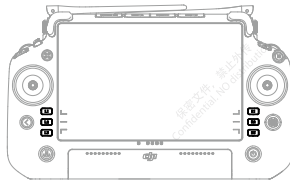

Button Customization and Combinations

Customizable Buttons

The L1, L2, L3, R1, R2, R3, C1, C2, C3, and 5D buttons are customizable. Open DJI Pilot 2 and enter camera view, tap **•••** > to configure the functions of these buttons.

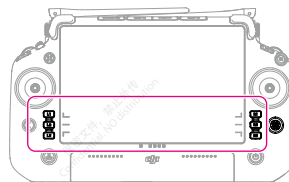
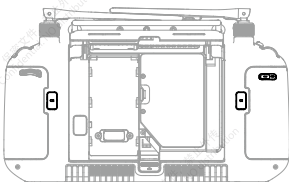

Combination Buttons

Some frequently-used features can be activated by using combination buttons. To use combination buttons, hold the back button and operate the other button in the combination. In actual use, enter the home screen of the remote controller, and tap Guide to quickly check all available combination buttons.

Aircraft Control Button

When using dual remote controllers, the aircraft control button is used to take control of the aircraft and indicate the aircraft control status. When the aircraft control is not locked by any remote controller:

- A. If the aircraft control button is green, press and hold the aircraft control button to lock the aircraft control. The aircraft control button will turn blue when the aircraft control is locked.
- B. If the aircraft control button is white, press the aircraft control button to lock the aircraft control. The aircraft control button will turn blue when the aircraft control is locked.

Press the aircraft control button again to unlock the control of the aircraft. An unlock prompt will appear in the app. Once unlocked, the other remote controller is able to gain and lock the control of the aircraft.

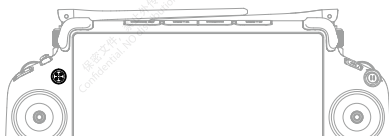

Button Color	Description
Red	The remote controller is not linked to an aircraft.
Solid green	The remote controller is linked to an aircraft and has control of the aircraft.
Solid blue	Aircraft control is locked and the remote controller has control of the aircraft.
White	The remote controller is linked to the aircraft without control of the aircraft. If the aircraft control is locked by another operator, the aircraft control button will flash after it is pressed.



- Only the remote controller with aircraft control can be used to start or cancel RTH.
- When the remote controller has full control, the control sticks are used for controlling the aircraft and the dials for adjusting gimbal movement.

Flight Mode Switch (N/S/F)

Toggle the switch to select a flight mode. Read the Flight Modes section for more information.

Icon	Flight Mode
F	F-mode (Function)
S	S-mode (Sport)
N	N-mode (Normal)

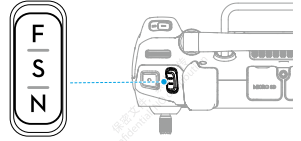

Calibrating the Compass

The compass may need to be calibrated after the remote controller is used in areas with electromagnetic interference. A warning prompt will appear if the compass of the remote controller requires calibration. Tap the warning prompt to start calibration. In other cases, follow the steps below to calibrate the remote controller.

1. Enter the home screen.
2. Open Settings, swipe up, and select Compass.
3. Follow the diagram on the screen to calibrate the remote controller.
4. The user will receive a prompt when the calibration is successful.



- If the remote controller compass is working normally, "Calibration Success" will be prompted after entering the calibration view. It is not necessary to perform the calibration.

HDMI Settings

The touchscreen can be shared with a display screen via an HDMI cable. The resolution can be set in Settings, Display, and then HDMI or in Camera View, HD settings, and then Video Output Resolution in the app.

Dual Control Mode

Inspire 3 supports Dual Control mode which allows two pilots to operate an aircraft simultaneously with remote controllers A and B. In this mode, both remote controllers have equal control of the aircraft. The roles of both remote controllers operating the aircraft are not assigned in advance. Instead, either pilot may gain control of the aircraft or the gimbal camera as needed, allowing for more flexibility during the operation.

Control over the aircraft is independent of control over the gimbal camera. When a remote controller gains control of the aircraft or the gimbal camera, the user can use the remote controller to operate the aircraft or control the movement of the gimbal camera respectively.



- In Dual Control mode, the aircraft can be connected with a DJI RC Plus remote controller and a DJI High-Bright Remote Monitor. Read the DJI Professional Ecosystem section for more information on the DJI High-Bright Remote Monitor.
-

Setting Dual Control Mode

Before using Dual Control mode, the pilot needs to link the aircraft with both remote controllers A and B. Follow the steps below to link the remote controllers.

1. Launch DJI Pilot 2.
2. Enter the home screen and tap Remote Controller A/B to activate linking. During linking, the status LED of the remote controller will blink blue and the remote controller will beep. Press and hold the power button on the aircraft for at least five seconds. The aircraft power indicator will blink and beep twice to indicate that linking has started. When linking is successful, the aircraft rear LED indicators will blink green, the remote controller beeps twice, and the remote controller status LED turns solid green.
3. After that, the aircraft control button on the remote controller will turn green or blue, and the user can take control of the aircraft, while the aircraft control button of the other remote controller will turn white. Tap gimbal camera icon on the camera view in DJI Pilot 2 to gain control of the gimbal camera.



- Link the two remote controllers one by one. Make sure to link remote controller A with the aircraft first, and then link remote controller B.
-

Using Dual Control Mode

1. Make sure both remote controllers are linked and connected with the aircraft before using Dual Control mode. By default, the first remote controller connected with the aircraft gains control of both the aircraft and the gimbal camera, while the second remote controller is not given any control.
2. When a remote controller has control of a device, whether it is the aircraft or the gimbal camera, the pilot can control the device by pushing the control sticks, turning the dial, pressing the shortcut buttons, or tapping the app user interface. The operation is the same as using a single remote controller. However, when a remote controller does not have control of a device, the pilot is unable to control the device. Only the remote controller with control of the aircraft can be used to start or cancel RTH.
3. Either pilot can take over control of a device as needed. The aircraft control button will turn blue when aircraft control is locked. Tap gimbal camera icon on the gimbal camera view in DJI Pilot 2 to gain control of the gimbal camera. The control sticks are used for operating the gimbal if the remote controller only has control over the gimbal camera. When the remote controller has full control, the control sticks are used for controlling the aircraft and the dials for adjusting gimbal movement.
4. In Dual Control mode, an aircraft control transfer mechanism will be triggered if the remote controller with aircraft control is disconnected from the aircraft. When this happens, the connected remote controller will receive a notification that the user may manually take over aircraft control. If the pilot of the connected remote controller chooses not to take over aircraft control, the aircraft will automatically perform the failsafe action. If the pilot of the

connected remote controller does not choose either option within a specified time period, the aircraft will also activate the failsafe action.

5. When the disconnected remote controller reconnects to the aircraft during the flight, if the aircraft control is not taken over by the connected remote controller, the aircraft control will be resumed to the remote controller before disconnection by default.
6. Only the remote controller with control of the gimbal camera can be used to adjust relevant settings for the gimbal and camera, and to download or playback media files.
7. Under normal circumstances, the pilots of both remote controllers can adjust flight-related settings, such as for the flight controller system, vision systems, batteries, and video transmission. However, if aircraft control is locked, only the remote controller with aircraft control can be used to adjust these settings.
8. Other non-flight-related operations can be performed using either remote controller.
9. The pilot of remote controller B cannot adjust settings for custom network RTK.
10. Remote controller A can be used to update the firmware of all modules at once when connected with the aircraft, but remote controller B can only be used to update the firmware of remote controller B.
11. Uploading Logs Using DJI Pilot 2: the operator can upload the logs of both the aircraft and remote controller A through remote controller A, and can upload the logs of remote controller B through remote controller B.
12. Remote controller B cannot be used to update the Fly Safe database.

DJI Professional Ecosystem

This chapter introduces on how to form DJI Professional Ecosystem with the other DJI products.

DJI Professional Ecosystem

DJI Inspire 3 can be used with other DJI products (sold separately), such as DJI Video Transmitter, DJI High-Bright Remote Monitor (abbreviated as remote monitor), DJI Three-Channel Follow Focus, and DJI Master Wheels to form a professional film ecosystem.

DJI Video Transmitter

Connection: connect the remote controller with the DJI Video Transmitter using an HDMI cable.

Usage: once connected, the liveview will be available to display on the remote monitors after linking the remote monitor to the video transmitter.

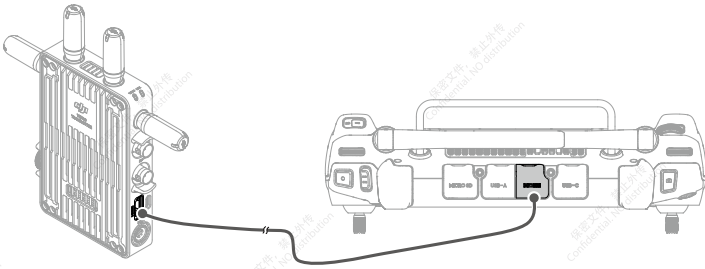

- Read the DJI Video Transmitter User Guide for more information.
- When using the remote controller with the video transmitter, keep a distance of at least 50 cm between them to avoid signal interference. If the remote controller signal still has interference, set the channel mode of the video transmitter to the DFS channel. Read the DJI High-Bright Remote Monitor User Guide for more information.

DJI High-Bright Remote Monitor

In Dual Control mode, the aircraft can link with a DJI RC Plus remote controller and a DJI High-Bright Remote Monitor, while the monitor can be used to observe the liveview and adjust the parameters.

Linking

1. Power on the remote monitor. Tap **•••** to enter System Settings, and then Connection Settings. Select Control Mode, set the monitor as Control Monitor B, and tap Link to Control Monitor B to enter linking status.
2. Press and hold the power button on the aircraft for at least five seconds. The aircraft power indicator will blink and beep twice to indicate that linking has started. When linking is successful, the aircraft rear indicators will blink green while the remote monitor will show a connected status.

- ⚠ • Even if the remote monitor is selected as Control Monitor A, the remote monitor will also work as Control Monitor B after being linked to the aircraft.
- Make sure the remote monitor is within 50 cm of the aircraft during linking.

Remote Monitor Liveview

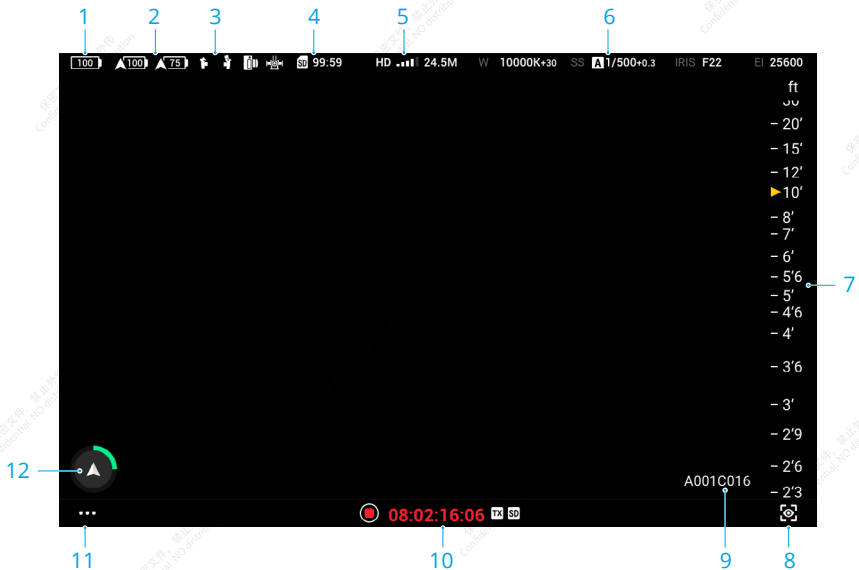

1. Remote Monitor Battery Level
2. Aircraft Battery Level
3. Connected Devices Status (such as DJI Three-Channel Follow Focus, and DJI Master Wheels)
4. Remote Monitor SD Card Storage Display
5. Video Transmission Signal Strength and Bitrate
6. Recording Parameters
7. MF Readings
8. Exposure Assist/Focus Assist Settings
9. Current Reel Information
10. Recording Button, Timecode and Current Storage Path
11. Remote Monitor System Settings
12. Navigation Display

- 💡 • Read the DJI High-Bright Remote Monitor User Guide to learn more usage information.

DJI Three-Channel Follow Focus

Mounting and Checking: mount the remote monitor with DJI Three-Channel Follow Focus, and then power on the remote monitor.

Usage: use the focus knob on the DJI Three-Channel Follow Focus to control the focus of the X9-8K Air camera lens.

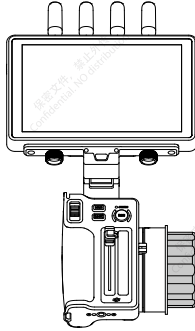

💡 • Read the DJI Three-Channel Follow Focus User Guide for more information.

DJI Master Wheels

Connection: mount the DJI Remote Monitor Expansion Plate to the remote monitor. Connect any one of the DC-OUT port on DJI Master Wheels to the DC-IN port on the expansion plate using the DJI High-Bright Remote Monitor Controller Cable.

Usage: once connected, use the wheels to control gimbal rotation.

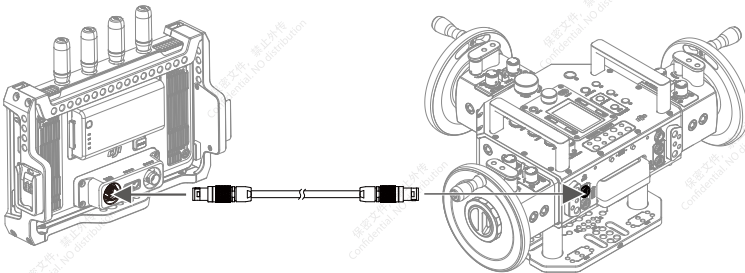

💡 • Read the DJI Master Wheels User Guide for more information.

Typical Application Scenarios

DJI Inspire 3 and the above DJI products can perform in various application scenarios. It allows two or three persons to operate the aircraft and gimbal while others view the liveview using third-party wireless monitors.

Scenario 1: using dual remote controllers to control the aircraft and the gimbal. It is applied to 2-person shooting, while the focus is adjusted using the remote controller dial by the aerial gimbal operator. It allows others to view the liveview from the third-party monitors wirelessly.

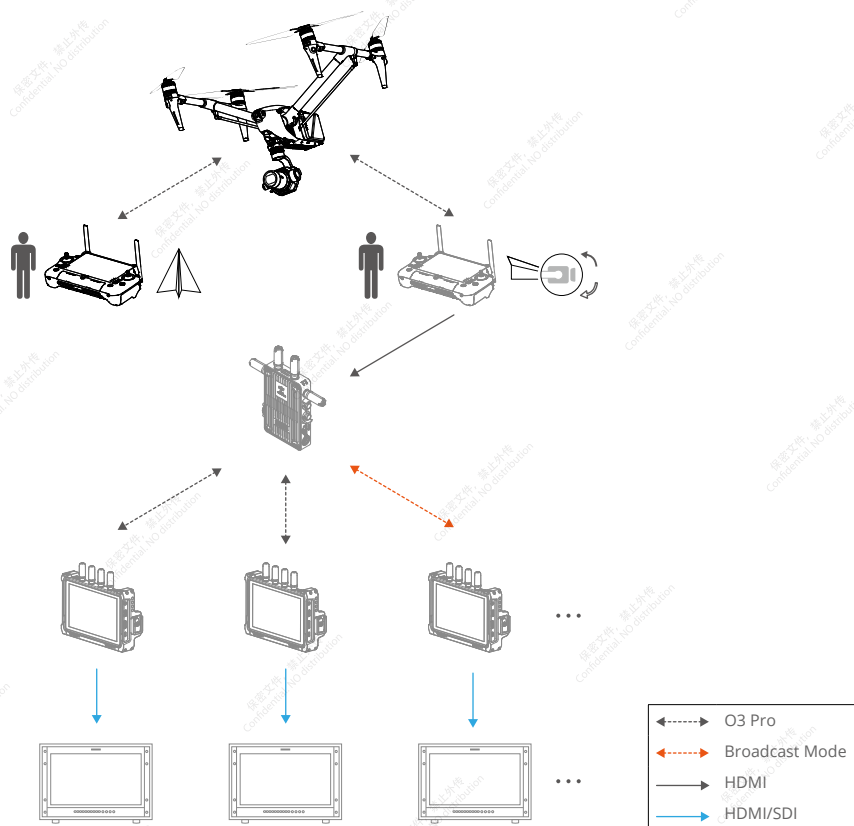

Scenario 2: using dual remote controllers to control the aircraft and the gimbal. It is applied to 3-person shooting, while the focus is adjusted using the three-channel follow focus connected to the remote monitor by the focus puller. This allows others to view the liveview from the third-party monitors wirelessly.

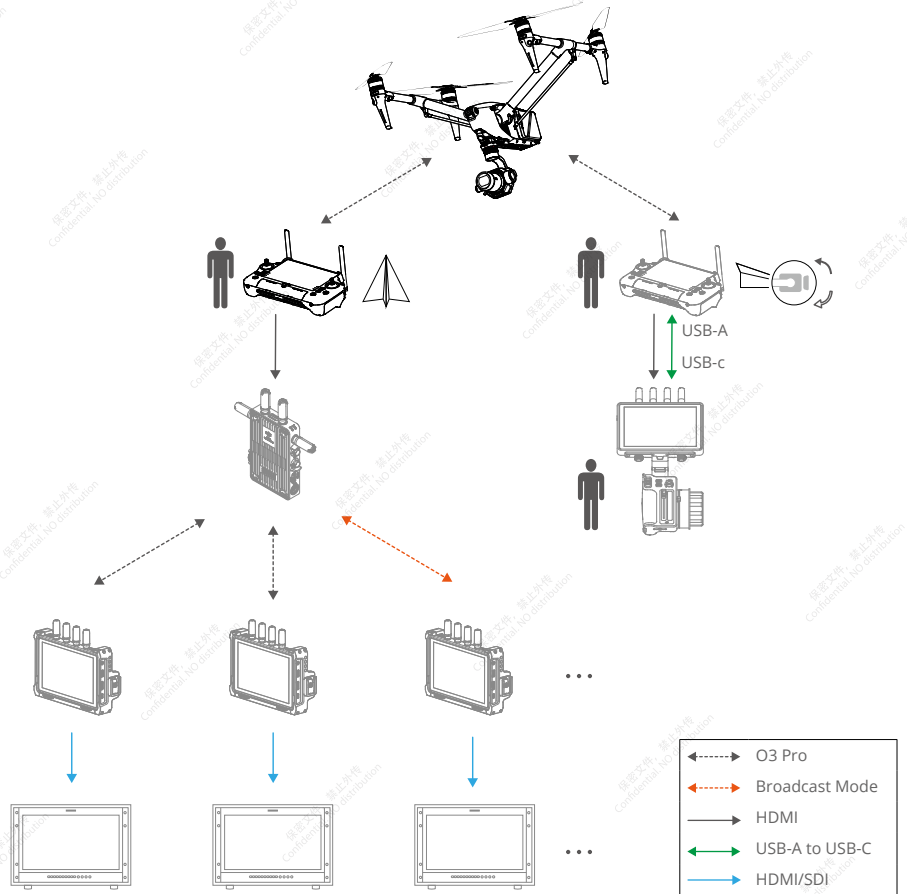

• Make sure to use the USB-A port when connecting the remote controller to the remote monitor.

Scenario 3: using a remote controller, a video transmitter, a three-channel follow focus, and multiple remote monitors. It is applied to 2-person or 3-person shooting, while the focus is adjusted by the focus puller. It allows others to view the liveview from the third-party monitors wirelessly or via wired connection.

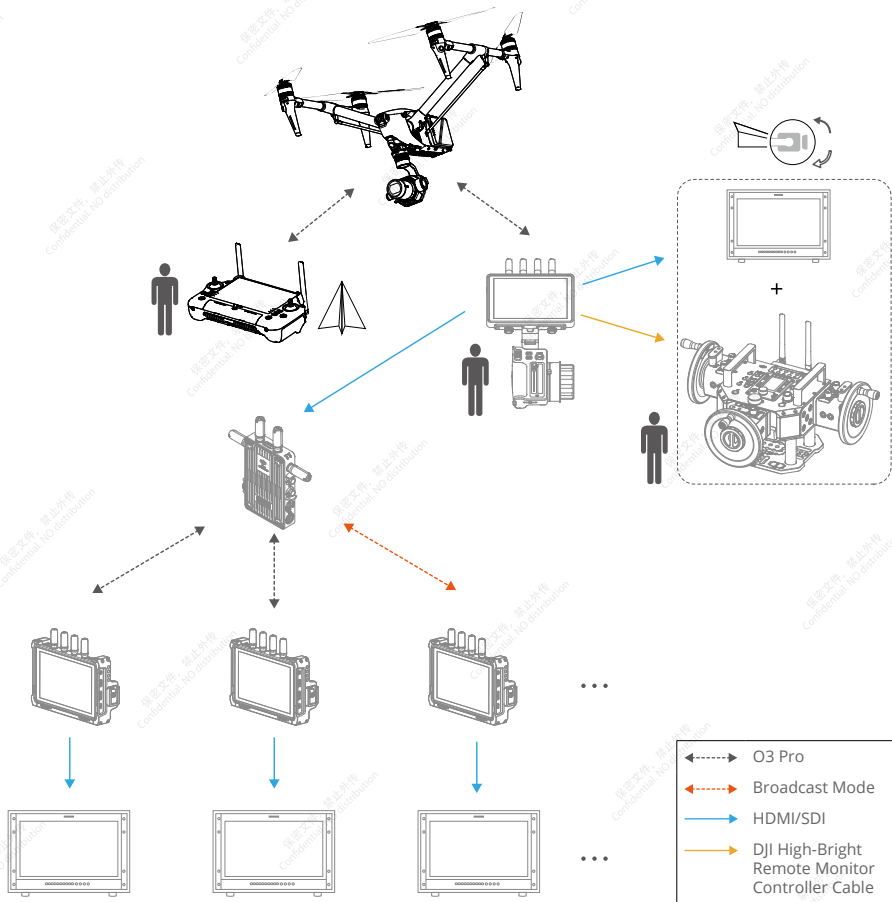

The following solutions can also be selected for connecting with the remote monitor:

1. Left Hand Grip (gimbal control), Right Hand Grip (focus adjustment)
2. Three-Channel Follow Focus (focus adjustment)
3. Master Wheels (gimbal control)

DJI Pilot 2 App

This chapter introduces the features of DJI Pilot 2.

DJI Pilot 2 App

The DJI Pilot 2 app integrates various professional functions for simple and efficient operations. The camera parameters can be set using the camera setting panel.

- ⚠️ • The use of the app is subject to DJI Pilot 2 Terms of Use and DJI Privacy Policy. Read them carefully in the DJI Pilot 2 app.
- Read all the DJI Pilot 2 app safety prompts, warning messages, and disclaimers carefully. Familiarize yourself with relevant regulations in your area. You are solely responsible for being aware of all relevant regulations and flying in a way that is compliant.
 - a. Read and understand the warning messages before resetting the Home Point.
 - b. Read and understand the warning messages and disclaimers before setting the altitude beyond the default limit.
 - c. Read and understand the warning messages and disclaimer before switching between flight modes.
 - d. Understand that the failsafe is how the aircraft will perform when disconnected from the remote controller, and the failsafe cannot be canceled before reconnecting to the remote controller. The default failsafe setting is Return-to-Home (RTH).

Homepage

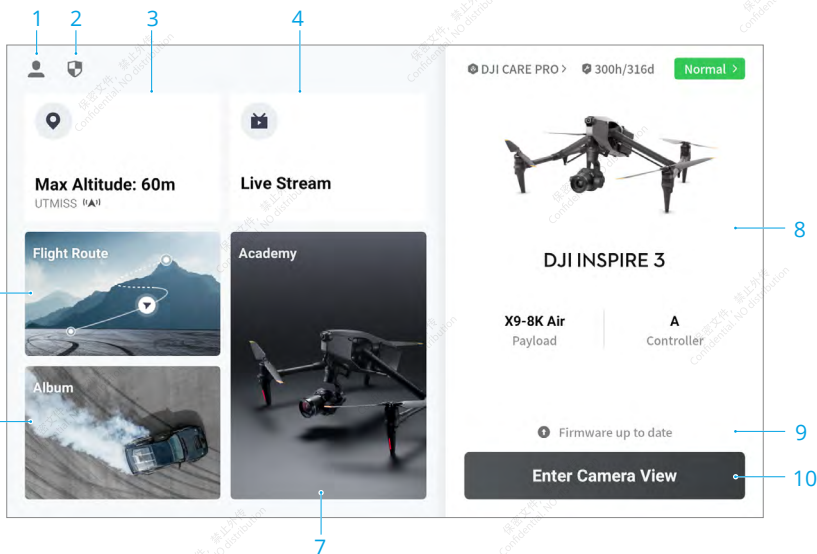

1. Profile

Tap to view flight records, download offline maps, manage GEO Zone unlocking, read help documentation, select a language, and view app information.

2. Data and Privacy

Tap to manage network security modes, manage app cache, and clear DJI device logs.

3. GEO Zone Map

Tap to view the GEO Zone map and check if the location is a restricted or authorization zone. Users can also check the maximum flight altitude by selecting the altitude zone.

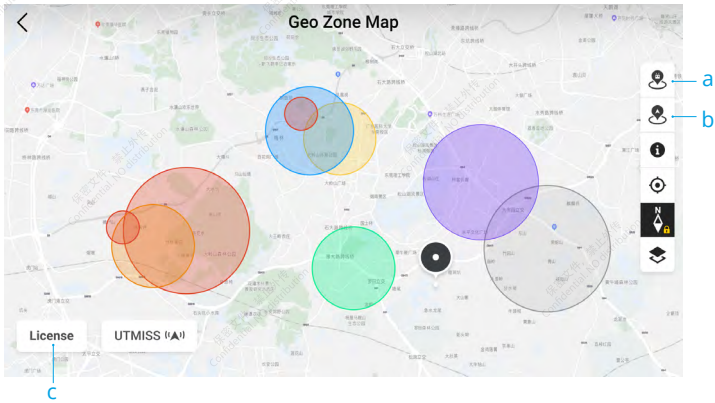

- Tap to update the GEO Zone database of the remote controller if an update is available.
- Tap to update the GEO Zone database of the aircraft if an update is available.
- Tap to enter and manage the unlocking certificate. If the aircraft is already connected to the remote controller, users can select the unlocking certificate directly to unlock the aircraft.

4. Livestream

The corresponding live URL and connection status will be displayed if connected to a livestream service such as RTMP or RTSP.

5. Flight Route Library

Tap to enter the flight route library. Users can create and view all flight tasks. Flight tasks can be imported and exported in batches to the remote controller or another external mobile storage device.

6. Album

Tap to view photos and videos of the aircraft and the local video cache of the remote controller. Support to save photos from the aircraft to the remote controller. Only videos cache of the remote controller can be viewed if the remote controller is disconnected from

the aircraft.

7. Academy

Tap to view Inspire 3 Tutorials, Flight Tips, and Case Studies, and download User Manuals to the remote controller.

8. Health Management System

Displays the health status of the aircraft, remote controller, and payload.



- If the current remote controller is not connected to the aircraft, a picture of the remote controller will be displayed. Tap to link the remote controller to the aircraft, the aircraft model and picture will be displayed after it is connected.
 - If the payload is abnormal, the payload name will appear in yellow or red. Tap to view the error information of the payload.
 - The current remote controller role is displayed as A or B. Tap to view the information of the remote controller or switch the remote controller role.
 - The health status of the aircraft and the remote controller is displayed here. Tap to enter the Health Management System view. Read the Health Management System (HMS) section for more details.
 - The maintenance information of the current aircraft is displayed here. If the aircraft has DJI Care Pro, its validity period will also be shown. Tap to view the device information, including cycle count, flight duration, flight history, activation time, flight mileage, etc.
- ## 9. Firmware Update Shortcut

If an update is necessary, a prompt will appear notifying the user that new firmware is available or a consistent firmware update is needed for the aircraft and remote controller.

Inconsistent firmware versions will affect flight safety. The app will prioritize consistent firmware updates. Tap the prompt to enter the firmware update page.



- A consistent firmware update is required when the firmware versions of some modules of the aircraft are inconsistent with the compatible version of the system. In a typical consistent firmware update situation, the aircraft, remote controller, and the batteries that are installed will be updated to the latest version. Any other batteries need to be updated separately. When these batteries are used, a prompt will appear requiring a consistent firmware update to ensure flight safety.

10. Enter Camera View

Tap to enter FPV camera view or gimbal camera view. Refer to the Gimbal Camera View and FPV Camera View sections for more details.

Gimbal Camera View

Introduction

After tapping Enter Camera View on the homepage of the DJI Pilot 2 app, the X9-8K Air gimbal camera view will display as the main view for the first time of use.





1. Live view from X9-8K Air gimbal camera.
2. Top Bar: displays product information such as aircraft status, flight mode, and signal quality. Refer to the Top Bar section for more details.
3. Camera Parameters: displays the current parameters of the camera, which can be adjusted in the Camera Quick Settings Panel. When using the remote controller shortcut keys to enable the Scroll Wheel to adjust exposure parameters, the corresponding parameter values will be highlighted in yellow.

EI	SS	IRIS	M.M	WB	Rec LUT	FF H.264	A073C0191	Lens	Time Code	MF	AE
200	1/60	16	-3.0	4820K +11	D-Log	4K(16:9) 60	00:16:28 24.1GB	35 mm	09:25:35:00		
	a			b		c	d	e	f	g	h

- a. Displays the current camera exposure parameters, including ISO (photo) / EI (video), shutter speed/angle, aperture, and EV/M.M.
- b. Displays the current color information.
In photo mode: displays white balance, including color temperature and color tone.
In video mode: displays white balance and recording LUT.
- c. Displays the current encoding format.
In photo mode: displays the frame, storage format, and photo resolution.
In video mode: displays the frame, video encoding, resolution and frame ratio, and

frame rate (project frame rate/sensor frame rate in S&Q mode).

- d. Displays the file name of the photo or video currently being shot or about to be shot, the remaining photo number/recording time, and the remaining capacity.
 - e. Displays the current lens focal length.
 - f. Displays the current timecode. The timecode display format is "hour: minute: second: non-drop frame" or "hour: minute: second; drop frame".
 - g. Displays the current focus mode. Tap to switch to AFS or MF.
 - h. AE lock switch.
4. Playback: tap to enter the aircraft album to view the photos or videos in the aircraft SSD and the local video cache of the remote controller. Among them:
 - JPEG: supports to be downloaded and played back.
 - RAW: supports to be downloaded, but only thumbnail played back.
 - J+R: only JPEG photos are supported to be downloaded and played back.
 5. Photo/Video Mode Settings: tap to switch between photo and video modes and select different shooting options.
 6. Shutter/Record Button: tap to take a photo or start or stop recording.
 7. Gimbal Slider: displays the tilt angle of the gimbal.
 8. Camera Quick Settings Panel: tap to set the camera exposure, color, and recording specifications. Read the Camera Quick Settings Panel section for more information.
 9. MF Scrollbar: used for manual focus operation.
 10. By default, press the R1 button to lower or raise the landing gear.
 11. By default, press the R2 button to switch between the camera view and the map view.
 12. By default, press the R3 button to switch between the gimbal camera view and the FPV camera view.
 13. Assistant Camera View: tap to switch the main camera view to the FPV camera view or the gimbal camera view. Supports zooming out.
 14. OSD Parameters: displays the horizontal distance, vertical distance, horizontal speed, and vertical speed.
 - Horizontal distance: displays the horizontal distance between the aircraft and the Home Point.
 - Vertical distance: displays the altitude of the aircraft relative to the takeoff point.
 - Horizontal speed: displays the current horizontal speed of the aircraft.
 - Vertical Speed: displays the current vertical speed of the aircraft.
 15. Navigation Display: displays aircraft, gimbal status, remote controller, Home Point, and obstacle avoidance information. Read the Navigation Display section for more information.
 16. By default, press the L3 button to enable the Scroll Wheel to adjust the Iris.
 17. By default, press the L2 button to enable the Scroll Wheel to adjust the Shutter.
 18. By default, press the L1 button to enable the Scroll Wheel to adjust the EI/ISO.
 19. Spotlight Pro: tap to enable Spotlight Pro to lock the camera orientation and look at the selected target. Read the Spotlight Pro section for more information.

20. Waypoint Pro: tap to enter the flight rout library, users can view and edit the flight route or create new flight routes. Read the Waypoint Pro section for more information.
21. Gimbal Mode: displays that the current state of the gimbal is Follow mode. Tap to switch to the Free mode. Refer to the Gimbal Camera section for a detailed description of each mode.
22. Auto Takeoff/Auto RTH: tap the / icon then long press to enable Auto Takeoff/Auto RTH.

-  • Tap anywhere on the screen and hold until a blue circle appears, drag the circle in any direction and the gimbal will rotate or tilt accordingly.
- Observe the focus frame color to learn the current focus status in AF mode.

Top Bar

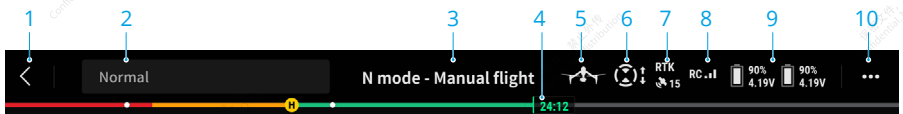

1. Back: tap to return to the home screen of the DJI Pilot 2 app.
2. System Status Bar: displays aircraft flight status and various warning messages. If an alert appears during flight, it will be displayed in the system status bar and continue flashing. Tap to view the message, and the flashing will stop.
3. Flight status:
 - a. The flight statuses include standby, preparing to take off, ready to go, manual flight, returning to home, landing, forced landing, and vision positioning.
 - b. When the aircraft is in vision positioning, standby, or manual flight status, the current flight mode will be displayed, including N, S, A, and T modes.
4. Intelligent Battery Information: displays the battery level and remaining flight time of the Intelligent Battery. Different battery levels are represented by different colors. When the battery level is lower than the warning threshold, the battery icon on the right turns red, reminding the user to land the aircraft as soon as possible and replace the batteries.
5. Landing Gear: displays the current landing gear status, tap to set the intelligent landing gear.
6. Obstacle Avoidance Status: displays the current obstacle avoidance status of the aircraft vision systems.
 - a. White: obstacle avoidance is enabled and is functioning normally.
 - b. Gray: obstacle avoidance is disabled.
 - c. Red: obstacle avoidance is enabled but failed.
7. GNSS Positioning Status: displays the number of searched satellites. When the aircraft RTK module is disabled, the RTK icon will turn gray. When enabled, the RTK icon will turn white. Tap the GNSS positioning status icon to view the RTK mode and GNSS positioning information.

8. **Signal Strength:** displays the O3 Pro signal quality. Three white bars indicate strong signal strength, two yellow bars for medium signal strength, and a red bar for poor signal quality. If the signal is lost, it displays a disconnected red icon.
9. **Intelligent Battery Level:** displays the battery level of the aircraft. Tap to view battery level, voltage, and temperature.
10. **Settings:** tap to open the Settings menu to set the parameters of each module. Configure the settings by following the corresponding instructions in app.
 - a. **✂ Flight Control System Settings:** include Home Point settings, multiple flight mode switch, flight mode, return to home, RTH altitude, maximum altitude, distance limit switch, maximum flight distance, landing gear settings, sensor status, gain & expo tuning, signal lost action, coordinated turn switch, and target scanning switch.
 - b. **📶 Sensing System Settings:** include obstacle avoidance mode, obstacle avoidance switch, and vision positioning switch.
 - c. **📡 Remote Controller Settings:** include remote controller channel, control stick mode, remote controller calibration, customizable RC buttons, notes for side buttons switch, and linking.
 - d. **HD Video Transmission Settings:** include work frequency, signal strength, video output type, video display mode, and video output resolution.
 - e. **🔋 Intelligent Battery Settings:** include battery information, Smart RTH switch, low battery warning thresholds, and time to battery self-discharge.
 - f. **📷 Gimbal Settings:** include gimbal pitch, pan and roll settings, gimbal pitch limit extension switch, gimbal calibration, and adjust gimbal.
 - g. **RTK RTK Settings:** include RTK positioning switch, RTK service type, and their corresponding settings and status displays.
 - h. **PRO Advanced Camera Settings:** include Monitoring, Storage, and Others.
 - i. **••• General Settings:** include map selection, show flight trajectory switch, unit settings, LED settings and ESC beeping switch.

Navigation Display

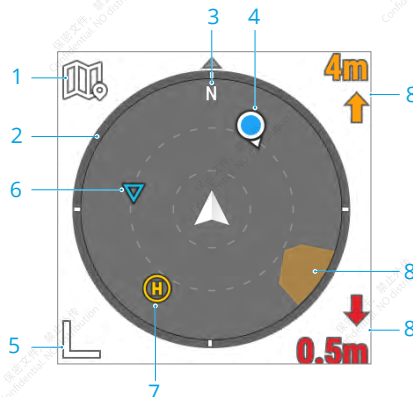

1. Tap to switch to the map view.
2. Gimbal Pan: displays the orientation of the gimbal relative to the aircraft in real time. The icon rotates with the gimbal.
3. Displays north direction.
4. Remote Controller Orientations:
 - a. Displays the position of the Home Point relative to the aircraft location. When the Home Point horizontal distance exceeds 16 m, the Home Point icon will stay on the edge of the Navigation Display.
 - b. When the relative distance between the Home Point and the remote controller is no more than 5 meters, only the Home Point will be displayed in Navigation Display. When the relative distance is more than 5 meters, the remote controller will be displayed as a blue dot to indicate its position. When the horizontal distance between the remote controller and the aircraft exceeds 16 meters, the remote controller position icon will stay on the edge of the Navigation Display.
 - c. The pointer on the blue dot can be used to indicate the direction the remote controller is facing when the compass of the remote controller is functioning properly. If the signal is poor during flight, point the arrow of the remote controller in Navigation Display to the direction of the aircraft.
5. Tap to zoom out.
6. Display the next waypoint during a Waypoint Pro flight task.
7. Display the current Home Point.
8. Obstacle Information: displays the obstacle information in vertical and horizontal directions, obstacle avoidance switch status, vision system working status, and aircraft behavior.

No obstacle information displays if both obstacle avoidance and the obstacle information display are disabled. NA shows that the vertical obstacle avoidance failed to work. TOF shows that the upward and downward vision systems failed to work, but infrared sensing system is functioning normally.



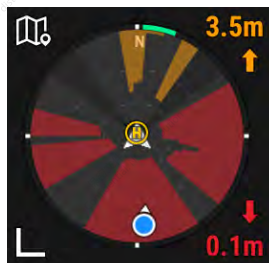
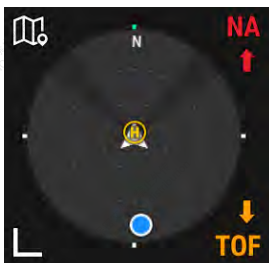

Once an obstacle is detected in the horizontal direction, the obstacle will be indicated by a frame icon. Once an obstacle is detected in the vertical direction, an obstacle distance will appear in the top or bottom right corner. When the aircraft reaches the warning distance, the icon will glow orange, and the remote controller will emit long beeping sounds. When the aircraft reaches the obstacle braking distance, the icon will glow red, and the remote controller will emit short beeping sounds. Both the obstacle braking distance and the warning distance can be set in DJI Pilot 2. Follow the prompted instructions in the app to set them.



Camera Quick Settings Panel

Tap  to enter the Camera Quick Settings panel and set the exposure for photos and videos and the image parameters.



1. Tap  to set the photo or video exposure parameters. Tap  to switch between shutter angle and shutter speed.
2. Tap  to set the image parameters such as white balance, sharpen, and noise reduction. Recording LUT, and monitoring LUT can also be set in video mode.
3. Tap to set the photo and video parameters.
 -  In Photo mode: set the photo format.
 -  In Video mode, set the frame, recording codec, resolution, FPS, and enable or disable S&Q.

Advanced Camera Settings Panel

Enter the DJI Pilot 2 camera view, tap **PRO** > **PRO** and then Advanced Camera Settings panel to set monitoring, storage, and other settings.

Monitoring Settings

Tap to set exposure assistant, display assistant, and focus assistant.

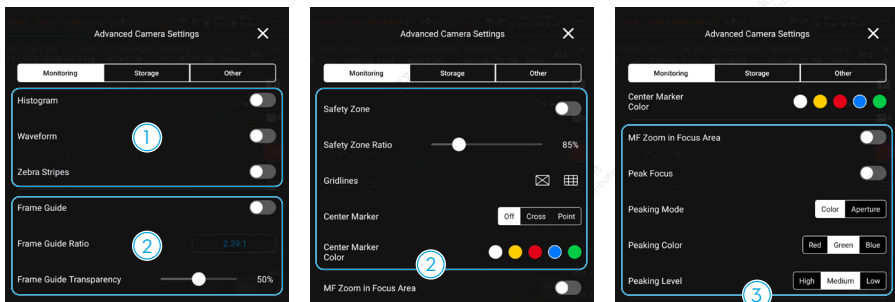

- Exposure Assistant: tap to enable the Histogram, Waveform, and Zebra Stripes (Histogram and Waveform cannot be enabled at the same time).
 - Histogram: displays a histogram in the camera view after enabled.
 - Waveform: indicates the bright and dark relation of the image using waveform. The waveform from left to right indicates the color of the image from left to right. The brightness will be shown as a waveform. The waveform is divided into four grids. The top grids indicate overexposure and the bottom grids indicate pure black.
 - Zebra Stripes: the area will be displayed in zebra stripes if the exposure exceeds the set level after being enabled.
- Display Assistant: includes frame guide, safety zone, gridlines, and center mark.
 - Frame Guide: the frame guide can be enabled or disabled in the liveview and the settings will not affect the recorded footage. The Frame Guide is only used to monitor the liveview and adjust the frame. The Frame Guide is set to off by default. Inspire 3 contains different aspect ratios for movie, TV, and web standards. Set the frame guide ratio and transparency after enabled.
 - Safety Zone: the safety zone is enabled by default. The safety zone is helpful when adjusting the frame, allowing users to reserve space for added information such as captions or icons. Set the safety zone ratio and transparency after enabled.
 - Tap to select the gridline mode.
 - Center Marker: indicates the center position of the liveview. Select the center marker and set the color after enabled.
- Focus Assistant: auxiliary tools for focusing.
 - MF Zoom in Focus Area: after enabling, the focus frame area can be automatically enlarged when using MF mode.
 - Peak Focus: after enabling, the focus area will be shown in sharp focus but will not affect the recorded footage. Set the peaking mode, peaking color and peaking level.

Storage Settings

Tap to set the reel information and DJI PROSSD.

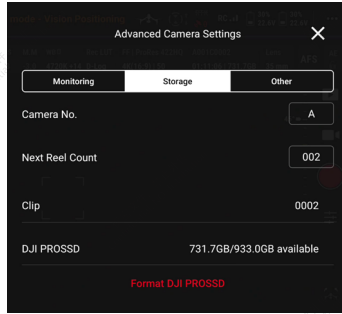

1. Reel Information Settings:

- Camera No.: tap to set the camera number, which can be set from A to Z. The camera number will be included in the footage name.
- Next Reel Count: tap to set the next reel count of the next storage device. The setting range is 1 to 999 and the next reel count will be included in the name of the recorded footage.

In the following scenarios, the camera will recognize the storage device as new storage. The current next reel count will be used in the next reel count when the recording begins and continue from the previous reel count.

- The selected storage did not record anything in this camera using this camera number.
- The selected storage is empty after formatting.

- Clip: displays the last recorded clip number with the camera using the current camera number. The clip number range is 0000 to 9999 and cannot be set. The folder name of the footage consists of the camera number, reel count, and the suffix of the Inspire 3 serial number.

The file name of the footage consists of the camera number, reel count, clip number, date, and the Inspire 3 serial number.

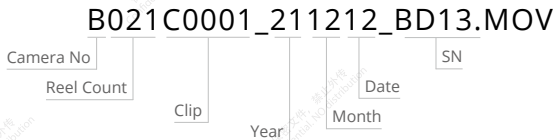

If the recording exceeds 3 hours, the footage will be stored as a new file, and the name of the file will be stored as the following clip number.

B021C0001...

B021C0002...

2. Storage Information:

- a. DJI PROSSD: displays remaining capacity and total capacity.
- b. Tap to format the DJI PROSSD.

Other Settings

Tap to set timecode, lens, LUT, metering mode, and anti-flicker.

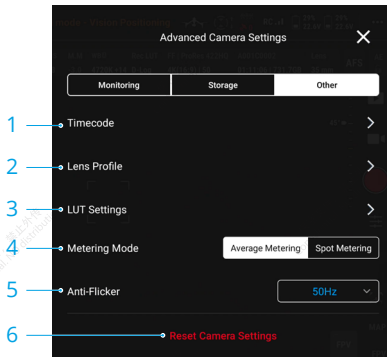

1. Timecode

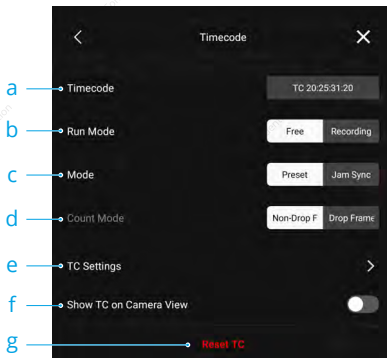

- a. Timecode: displays the current aircraft timecode. EXT icon indicates that there is an external timecode synchronizer connected to the aircraft.
- b. Run Mode

The Run mode can be set to Free Run or Recording Run. When set to Free Run, the time code will add one frame for every frame the sensor generates regardless of whether the camera is recording or not. When the project frame rate is different from the sensor frame rate, the camera will automatically switch to Recording Run as the time code frame rate cannot match the sensor frame rate. When set to Recording Run, the time code will only add one frame for every frame generated by the sensor during recording and the

time code will be continuous throughout all recorded footage.

c. Mode

Mode can be set to Preset or Jam Synced.

Preset can be selected in both run modes. In Preset mode, tap TC settings or Reset TC to customize the initial value. Jam Synced can only be selected in Free Run mode and requires connecting an external timecode synchronizer to the aircraft.

d. Count Mode

Count mode can be set to Drop Frame or Non-Drop Frame. In Drop Frame mode, the timecode will skip the first two frames of each minute except every 10th minute. The Drop Frame will be used when the project frame rate is 29.97fps or a multiple of 29.97fps. In Non-Drop Frame mode, the timecode will count every frame the sensor generates.

e. Timecode settings.

f. Show TC on Camera View

Tap to enable the timecode display on the liveview.

g. Reset Timecode

Tap to reset the timecode.

2. Lens Profile

Tap to view the lens model and calibration status. Focus calibration is available.

3. LUT Settings

Supports custom LUT. Tap LOOK to select and manage a LUT. Inspire 3 supports up to 16 LUT files to read and display.

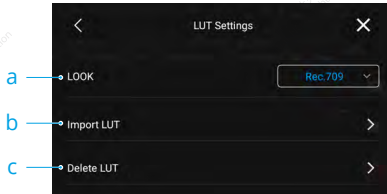

a. LOOK

Supports custom LUT from the user. The custom LUT will be applied when LOOK is selected.

b. Import LUT

To add a LUT file, select import and select the LUT file.

Copy the 33 point 3D LUT file name with .CUBE to the root directory of the storage and attach the storage to the main body. Only use letters or numbers to name the LUT file and DO NOT use special characters or spaces. Make sure the storage has been formatted before saving the custom LUT.

c. Delete LUT

To delete a LUT file, select the file, tap delete, and then cancel to check the updated list.

4. Metering Mode

Tap to set to average metering or spot metering.

5. Anti-flicker

Anti-flicker is only available in Photo mode, which can be set to Off, Auto, 50Hz, or 60Hz.

6. Reset Camera Settings

Tap to reset the camera settings.

Waypoint Pro

Instruction





Waypoint Pro can be used to plan the flight route for the aircraft in advance. By manually adding waypoints or enabling Auto Add Waypoint on to create a flight route, and editing the waypoints, the aircraft can fly to all waypoints and complete preset actions to realize automatic flight.

Waypoint Pro provides two modes, including Repeatable Routes and 3D Dolly. During the Repeatable Routes mode, the aircraft can automatically fly on the same route and automatically maintain all preset parameters such as the flight altitude, flight speed, and gimbal angle. During the 3D Dolly mode, the aircraft can be controlled by the remote controller to fly on the same route. Unlike the Repeatable Routes mode, the 3D Dolly mode can maintain the same flight route at all times and flexibly control the aircraft to move forward and backward on the preset route repeatedly.

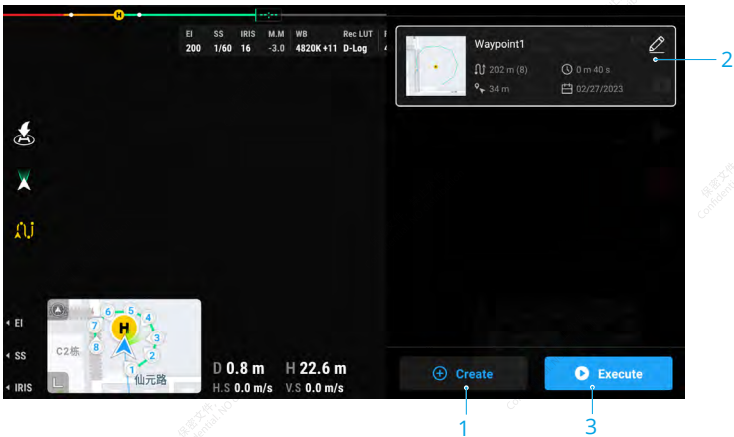
Waypoint Pro Usage

Tap  to open the Waypoint Pro setting panel in either camera view or map view. Camera view is used as the example.



- After takeoff, if the aircraft status displayed on the top bar is manual flight, tap  to show the Flight Route Library panel, and tap  to create a new flight route. Waypoints can be added using the method below.
 - Manual Add Waypoint: press the C1 button on the remote controller to create a waypoint, and press the C2 button on the remote controller to delete the current waypoint.
 - Auto Add Waypoint: after enabling Auto Add Waypoint, DJI Pilot 2 will regularly record the aircraft position, orientation, gimbal angle, and other information according to the set time interval and create waypoints accordingly.
- View the recent flight route list. Tap  to open the flight route editor if a flight route needs to be edited. Read the Flight Route Editor section for more information.
- Select the desired flight route from the flight route list. Tap  to enter the waypoint Pro

settings panel, select the Repeatable Routes mode or 3D Dolly mode, and set the parameters accordingly.

- When using 3D Dolly, Control Mode can be set as Auto or Manual. In Auto mode, the aircraft will automatically maintain the preset aircraft orientation and the gimbal pan and tilt according to the route position. In Manual mode, users can control the aircraft orientation and the gimbal pan and tilt using the control sticks and dials.

4. Tap Start to begin and execute the flight route mission, the flight route progress panel will be displayed in the liveview accordingly. Use the Repeatable Routes mode display as an example.



- ▶ Flight route execution progress
- 📍 Completed waypoint number/Total waypoint number
- ⏸ Tap to pause the flight
- 📏 Completed flight route length/Total flight route length
- 🌀 Flight route speed
- 🕒 Elapsed time/Estimate total time

5. Tap in the camera view to exit the flight.

Flight Route Editor

After selecting a flight route in the flight route library, tap to open the flight route editor on the map view.

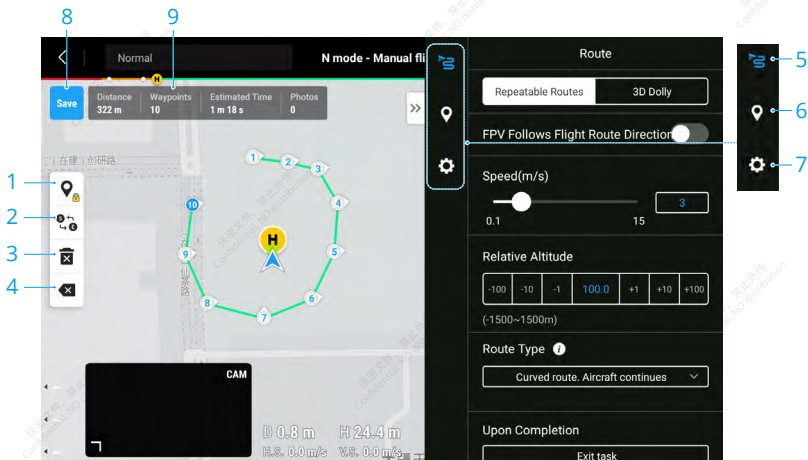

1. Waypoint Editing Switch on Map: tap to enable adding waypoint and dragging waypoint on map. Tap this icon again to disable editing the waypoints.
2. Reverse Flight Route: tap to reverse the flight route by swapping the start and endpoint.

3. Clear Waypoints: tap to clear all the added waypoints.
4. Delete Selected Waypoints: tap to delete the selected waypoints.
5. Flight Route Settings: flight route settings are applied to the entire route.
6. Individual Waypoint Settings: select a waypoint and set the parameters applied to the waypoint.
7. General Settings: set other parameters such as the flight route name and altitude mode.
8. Save: tap to save the flight route.
9. Flight Route Information: displays the flight route length, waypoint number, estimated flight time, and photo quantity.

Spotlight Pro

Instruction

Spotlight Pro uses the vision systems to recognize and predict so as to keep the target in the view. At this time, the gimbal will automatically adjust the camera and keep it facing the target. The mode supports the capturing of both stationary and moving subjects. Moving subjects specifically refer to vehicles, boats, and people, which can be automatically identified.

When the gimbal is in Follow Mode: when the aircraft rotates horizontally, the gimbal rotates accordingly with the angle between the gimbal pan and the aircraft heading unchanged. When using the control sticks to move the aircraft: move the roll stick to circle the subject, pitch stick to alter the distance from the subject, throttle stick to change the altitude, and yaw stick to adjust the frame.

When the gimbal is in Free Mode: when the aircraft rotates, the gimbal orientation is pointing to the target all the time without following the rotation of the aircraft.



In Spotlight Pro mode, when the vision systems are working normally and the obstacle avoidance is set to Brake in the app, the aircraft will hover if an obstacle is detected. Note: obstacle avoidance is disabled in Sport mode.

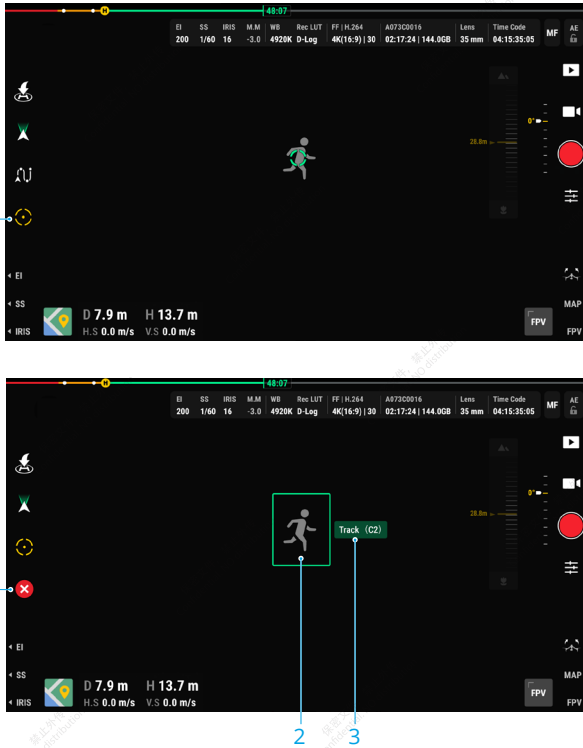

- It is recommended to only track vehicles, boats, and people (but not children). Fly with caution when tracking other subjects.
- In supported moving subjects, vehicles refer to cars and small to medium-sized yachts.
- The tracking subject may inadvertently swap to another subject if they pass nearby to each other.
- Spotlight Pro is unavailable when the aircraft is on the ground.

Spotlight Pro Usage



1. **Enabling Spotlight Pro:** tap  to enable or disable Spotlight Pro.
2. **Selecting the Target:**
 - a. **Drag-Select Target:** after enabling Spotlight Pro, tap and drag on the screen to select a target. If the target is too small or not identified, drag-select target may fail.
 - b. **Tap-Select Target:** after enabling the Target Scanning in the Flight Control Settings, the target will be identified and displayed in the app, tap  to track the target.
3. **Tracking the Target:** after selecting the target, tap the Track button next to the target frame or press the C2 button on the remote controller to start tracking the target.
4. Tap  to reselect the target.

 • When the target is blocked or beyond the screen, the app will predict the target position and track the position.

- Gimbal mode can be switched during tracking:



Free Mode: the movements of the aircraft in Free Mode are as shown below:

Roll Stick: move to change the aircraft's rotation around the target.

Pitch Stick: move to change the aircraft's distance from the target.

Throttle Stick: move to change the aircraft's altitude.

Yaw Stick: move to adjust the horizontal view.

Gimbal Pitch Dial: move to adjust the vertical view.



Follow Mode: the gimbal pan dial adjusts the horizontal view, and the gimbal pitch adjusts the vertical view. Read the Control Stick Modes section in the Remote Controller chapter for more information on how to control the aircraft.

FPV Camera View

When switching the FPV camera to work as the main view, the FPV camera liveview is displayed.

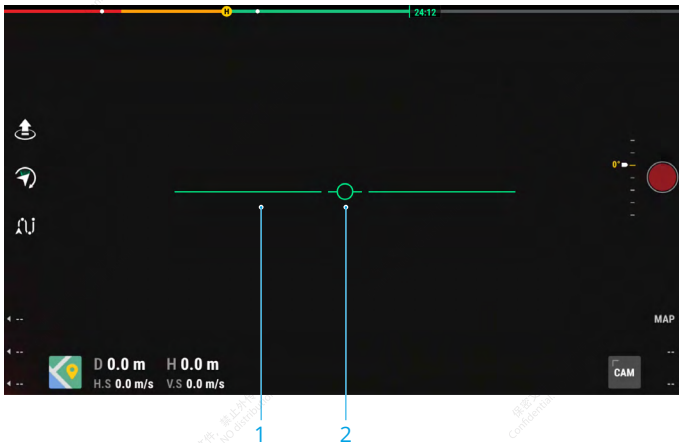

1. Artificial Horizon: displays the current horizon position.
2. Aircraft Heading Indicator: displays the tilt angle of the aircraft body.

Full Screen Mode

In the gimbal camera view or the FPV camera view, slide two fingers down on the screen to enter or exit the Full Screen mode.

Map View

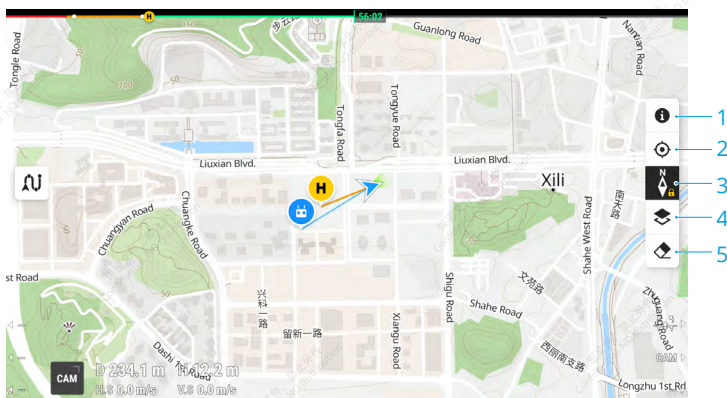

1. GEO Zone Map Layers: tap to view all GEO Zone layers and enable or disable the GEO Zones layer display on the map.
2. Recenter View: tap to center the remote controller location in the view.
3. Map Lock: when enabled, the map cannot be rotated. When disabled, the map can be rotated freely.
4. Map Layer Selection: tap to select a satellite or street map (standard mode) according to operational requirements.
5. Clear Flight Trajectory: tap to clear the flight trajectory of the aircraft.

Health Management System (HMS)

The HMS system includes Error Diagnosis, DJI Care Pro, Basic Service, Firmware Update, and Manage Logs.

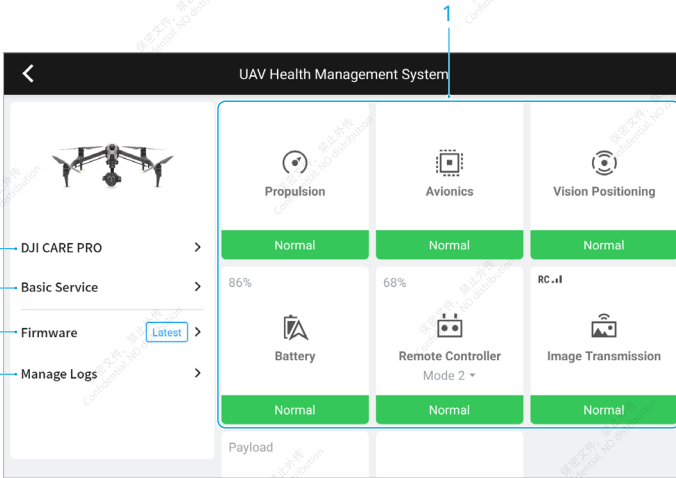

1. Error Diagnosis: for checking the current status of each aircraft module. Users can solve issues by following the corresponding prompted instructions.

Color	Status
Green	Normal
Orange	Caution
Red	Warning

2. DJI Care Pro: relevant information can be viewed if the device is bound to DJI Care Pro.
3. Basic Service: users can view historical flight data and refer to the maintenance manual to determine if maintenance is required.
4. Firmware Update: tap to enter the Firmware Update page.
5. Manage Logs: displays the remote controller and aircraft log data of recent flights. Users can assist by exporting and saving the relevant logs locally or uploading them directly to the DJI Support cloud to help DJI Support solve issues.



- Manage Logs is available for the batteries and battery hub (the battery hub must be connected to the remote controller via the USB-C to USB-A data cable).

Battery Hub Status and Log Management

To check the battery hub status in HMS in DJI Pilot 2, connect the battery hub to the remote controller via a USB-C to USB-A data cable. The user can also update the battery hub and battery firmware and export the battery hub and battery logs in batches.

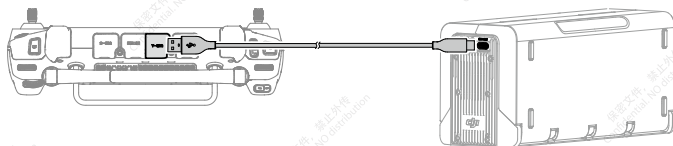

Checking the Battery Hub Status

Run DJI Pilot 2, tap HMS to check the status of the battery hub and batteries. If a warning appears, tap it for more detailed information and follow the prompted instructions to resolve the issue.

Exporting the Battery Hub Logs

1. Run DJI Pilot 2, tap HMS, then Manage Logs, and select Battery Hub Logs.
2. Check the logs of the battery hub and all batteries.
3. Tap Upload Log and follow the prompted instructions to upload the selected logs.

Flight

This chapter introduces the safe flight practices and flight restrictions.

Flight

Make sure to have training and practice before operating any actual flight. Practice with the simulator in DJI Assistant 2 or fly under the guidance of experienced professionals. Pick a suitable area to fly in according to the following flight requirements and restrictions. Fly the aircraft below 120 m (400 ft). Any flight altitude higher than that may violate local laws and regulations. Make sure you understand and comply with the local laws and regulations before flying. Read the Safety Guidelines carefully to understand all safety precautions before flying.

Flight Environment Requirements

- DO NOT fly the aircraft in severe weather conditions, including strong winds (speeds exceeding 14 m/s), sandstorms, snow, rain, smog, hail, lightning, tornadoes, or hurricanes.
- Only fly in open areas. Tall structures and large metal structures may affect the accuracy of the onboard compass and GNSS system. It is recommended to keep the aircraft at least 5 m away from structures.
- Avoid obstacles, crowds, high voltage power lines, trees, and bodies of water. It is recommended to keep the aircraft at least 3 m above water.
- Minimize interference by avoiding areas with high levels of electromagnetism such as locations near power lines, base stations, electrical substations, and broadcasting towers.
- Aircraft and battery performance is subject to environmental factors such as air density and temperature. DO NOT fly the aircraft higher than 3,800 m (12,467 ft) above sea level when using the foldable quick-release propellers, or higher than 7,000 m (22,965 ft) above sea level when using the foldable quick-release propellers for high altitude. *
- Aircraft cannot use GNSS within the polar regions. Use the vision system when flying in such locations.
- DO NOT take off from moving objects such as cars, ships, and airplanes.
- To avoid affecting the motor service life, DO NOT take off or land the aircraft on sandy or dusty areas.
- DO NOT use the aircraft, remote controller, battery, and charging hub near accidents, fires, explosions, floods, tsunamis, avalanches, landslides, earthquakes, dust, or sandstorms.
- Use the charging hub in a temperature range of -20° to 40° C (-4° to 104° F).
- Operate the aircraft, battery, remote controller, and charging hub in a dry environment.
- DO NOT use the aircraft in dusty or humid environments.
- DO NOT use the charging hub in humid environments.
- Make sure the temperature and humidity is suitable for the gimbal camera during usage.
- This product shall not be used in potentially explosive atmosphere.

* Measured in a gentle breeze with the gimbal camera and lens installed on the aircraft. The value provided should be used for reference only.

Operating the Aircraft Responsibly

Observe the following rules to avoid non-compliant behaviour, serious injury, and property damage:

- DO NOT operate in the vicinity of manned aircraft. DO NOT interfere with the operations of manned aircraft. Be alert and avoid other aircraft at all times. Land immediately if necessary.
- DO NOT fly the aircraft in venues of major events, including but not limited to sporting events and concerts.
- DO NOT fly the aircraft without authorization in areas prohibited by local laws. Prohibited areas include airports, national borders, major cities and densely populated areas, venues of major events, areas where emergencies have occurred (such as forest fires), and locations with sensitive structures (such as nuclear power plants, power stations, hydropower plants, correctional facilities, heavily traveled roads, government facilities, and military zones).
- DO NOT fly the aircraft above the authorized altitude.
- Keep your aircraft within visual line of sight (VLOS).
- DO NOT use the aircraft to carry illegal or dangerous goods or payloads.
- Make sure you understand the nature of your flight operation (such as for recreation, public, or commercial use) and have obtained the corresponding approval and clearance from the related government agencies before flight. Consult with your local regulators for comprehensive definitions and specific requirements. Note that remote controlled aircraft may be banned from conducting commercial activities in certain countries and regions. Check and follow all local laws and ordinances before flying as those rules may differ from those stated here.
- Respect the privacy of others when using the camera. DO NOT conduct surveillance operations such as video recording or capturing images of any person, entity, event, performance, exhibition, or property without authorization or where there is an expectation of privacy, even if the image or video is captured for personal use.
- Be advised that in certain areas, the recording of images and videos from events, performances, exhibitions, or commercial properties by means of a camera may contravene copyright or other legal rights, even if the image or video was shot for personal use.

Flight Limits and GEO Zones

GEO (Geospatial Environment Online) System

DJI's Geospatial Environment Online (GEO) System is a global information system that provides real-time information on flight safety and restriction updates and prevents UAVs from flying in restricted airspace. Under exceptional circumstances, restricted areas can be unlocked to allow flights in. Prior to that, the user must submit an unlocking request based on the current restriction level in the intended flight area.

The GEO system may not fully comply with local laws and regulations. Users shall be responsible for their own flight safety and must consult with the local authorities on the relevant legal and regulatory requirements before requesting to unlock a flight in a restricted area. For more information about the GEO system, visit <https://fly-safe.dji.com>.

Flight Limits

For safety reasons, flight limits are enabled by default to help users operate this aircraft safely. Users can set flight limits on height and distance. Altitude limits, distance limits, and GEO zones function concurrently to manage flight safety when GNSS is available. Only altitude can be limited when GNSS is unavailable.

Flight Altitude and Distance Limits

Maximum flight altitude restricts the aircraft flight altitude, while maximum flight distance restricts the aircraft flight radius around the Home Point. These limits can be set using the DJI Pilot 2 app for improved flight safety.

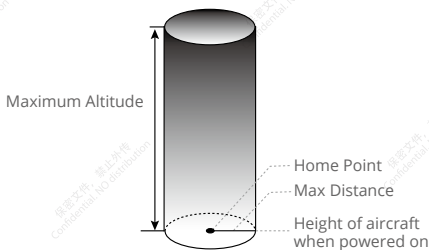

Home Point not manually updated during flight

Strong GNSS Signal		
	Restriction	Prompt in DJI Pilot 2
Max Altitude	Altitude of the aircraft cannot exceed the value set in DJI Pilot 2.	Aircraft approaching max flight altitude. Fly with caution.
Max Distance	The straight-line distance from the aircraft to the Home Point cannot exceed the max flight distance set in DJI Pilot 2.	Aircraft approaching max flight distance. Fly with caution.

Weak GNSS Signal

	Restriction	Prompt in DJI Pilot 2
Max Altitude	When the GNSS signal is weak, namely when the GNSS icon is yellow or red, and the ambient light is too dark, the max altitude is 3 m (9.84 ft). The max altitude is the relative altitude measured by the infrared sensor. When the GNSS signal is weak but the ambient light is sufficient, the max altitude is 30 m (98.43 ft).	Aircraft approaching max flight altitude. Fly with caution.
Max Distance	No limit	N/A



- In the case where an aircraft exceeds a specified limit, the pilot can still control the aircraft but is unable to fly the aircraft any closer to the restricted area.
- For safety reasons, DO NOT fly aircraft near airports, highways, railway stations, metro stations, city centers, or other sensitive areas. Only fly the aircraft in areas that are within your direct line of sight.
- Fly no higher than 120 m (400 ft) above ground level and stay away from any surrounding obstacles.
- To fly above the default altitude limit, accept the disclaimer prompt to enable the new altitude limit.



- Flight altitude restrictions vary in different regions. DO NOT fly above the maximum altitude set forth in your local laws and regulations.

GEO Zones

All GEO zones are listed on the DJI official website at <https://fly-safe.dji.com> and may be updated at any time. GEO zones are divided into different categories and include locations such as airports, flying fields where manned aircraft operate at low altitudes, borders between countries, and sensitive locations such as power plants.

There will be prompts in the DJI Pilot 2 app to fly in GEO zones.



- The settings and alerts provided by DJI on operations within GEO Zones are only to assist the user in ensuring flight safety and DO NOT guarantee full compliance with all local laws and regulations. Before each flight, the user is responsible for seeking advice on the relevant local laws, regulations, and requirements for the safety of their own aircraft.
- Flight-related functions will be affected to varying extent when the aircraft is near or inside a GEO Zone. This includes but is not limited to the aircraft slowing down, being unable to create a Home Point or flight task, and interruption of a flight task.

Calibrating the Compass

Only calibrate the compass when prompted to do so by the DJI Pilot 2 app or the aircraft rear indicators. Observe the following rules when calibrating the compass:

- 💡 • It is recommended to calibrate the compass to ensure the quality of the images and videos when features require high aircraft orientation accuracy, such as long-time exposure during hovering.
- DO NOT calibrate the compass in locations with strong magnetic interference, such as near magnets, parking lots, or construction sites with underground reinforced concrete structures.
- DO NOT carry ferromagnetic materials such as mobile phones during calibration.
- DJI Pilot 2 will display a prompt if the compass is affected by strong interference after calibration is complete. Follow the displayed instructions to resolve the compass issue.

Calibration Procedure

Perform the calibration in an open area and follow the steps below to complete the calibration.

1. Run the DJI Pilot 2 app and enter the camera view on the home screen. Tap **•••** > **⚙️** > **Sensor Status**, then **Compass**, and **Calibrate Compass** to start the calibration. The aircraft rear LED indicators will glow in solid yellow, which indicates that the calibration has started.
2. Hold the aircraft horizontally 1.5 m (4.92 ft) above the ground and rotate the aircraft 360 degrees. The aircraft rear LED indicators will glow in solid green.
3. Hold the aircraft vertically and rotate the aircraft 360 degrees.

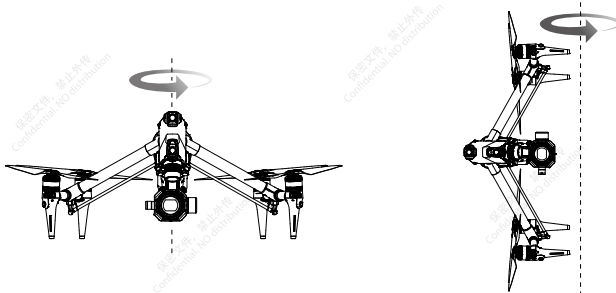

4. Re-calibrate the aircraft if the aircraft rear LED indicators blink red.

- ⚠️ • If the aircraft rear LED indicators blink red and yellow alternately after the calibration is complete, it indicates strong interference in the current location. Move your aircraft to a different location and try again.

- 💡 • A prompt will appear in DJI Pilot 2 if compass calibration is required before takeoff. The prompt will disappear after the calibration is complete.
- If the compass calibration is complete, place the aircraft on the ground. If the prompt appears again in DJI Pilot 2, try moving the aircraft to a different location before recalibrating the compass.

Pre-Flight Checklist

1. Only use genuine parts that are in good condition. DO NOT modify or alter the aircraft, its components, or parts. Make sure that when installing any external devices that the total weight of the aircraft does not exceed the maximum takeoff weight. In addition, the external device must be installed in a location so that the center of gravity is maintained within the range of the aircraft top shell to keep the aircraft stable and that the vision systems, the infrared sensing systems, and the auxiliary lights are not blocked.
2. Make sure all devices, such as remote controller and intelligent batteries, are fully charged.
3. Ensure there are no foreign objects such as water, oil, soil, or sand inside of the aircraft or its components. The air vents of the aircraft, the cooling holes of the camera, and the ventilation holes of the motor are not blocked.
4. Make sure the propellers are securely mounted and not damaged or deformed. DO NOT use chipped or broken propellers.
5. Make sure the aircraft motors are clean and in good condition. Rotate the propeller to examine the motor and make sure the motor can rotate smoothly without abnormal sound. Otherwise, stop using the aircraft immediately and contact DJI Support.
6. Make sure the camera lens is clean and in good condition and the gimbal can rotate unobstructed.
7. Make sure the lenses of the vision systems, gimbal camera, FPV camera, the glass of the infrared sensors, and the auxiliary lights are clean and not blocked in any way.
8. Make sure the covers of ports have been closed firmly.
9. Make sure the flight area is outside any GEO zones, and flight conditions are suitable for flying the aircraft.
10. Place the aircraft on open and flat ground. Make sure there are no obstacles, buildings, or trees nearby and that the aircraft is 5 m away from the pilot. The pilot should be facing the rear of the aircraft.
11. Make sure that the ESC is beeping after powering on the aircraft.
12. Make sure DJI Pilot 2 is properly running to assist with the flight. Without the flight data recorded by the DJI Pilot 2 app in certain situations (including the loss of your aircraft), DJI may not be able to provide aftersales support to you or assume liability.
13. Make sure DJI Pilot 2 and the aircraft firmware have been updated to the latest version.
14. If required before a flight, follow the prompts in the app to fix any abnormalities with the ESCs.
15. Make sure that the DJI Pilot 2 app displays at least 6 satellites.
16. Check if the Remote ID is up to date and working.

Auto Takeoff/Auto Return to Home



Auto Takeoff

Use the Auto Takeoff function:

1. Launch DJI Pilot 2 and enter the gimbal camera view.
2. Complete all steps in the pre-flight checklist.
3. Tap . If conditions are safe for takeoff, press and hold the button to confirm.
4. The aircraft will takeoff and hover approx. 1.2 m (3.9 ft) above the ground.

Auto Return to Home

Use the Auto RTH function:

1. Tap . If conditions are safe to land, press and hold the button to confirm.
2. Auto RTH can be canceled by tapping .
3. If the Downward Vision System is working normally, Landing Protection will be enabled.
4. Motors will stop automatically after landing.

 • Choose the proper place for landing.

Starting/Stopping the Motors

Starting the Motors

A Combination Stick Command (CSC) is used to start the motors. Push both sticks to the inner or outer bottom corners to start the motors. Once the motors start spinning, release both sticks simultaneously.

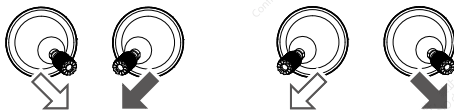



Stopping the Motors

The motors can be stopped in two ways:

Method 1: When the aircraft has landed, push the throttle stick down and hold. The motors will stop after three seconds.

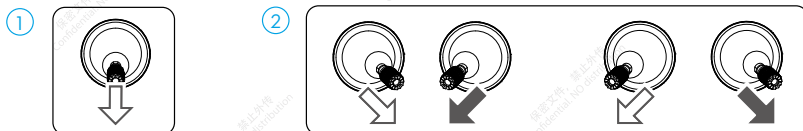
Method 2: When the aircraft has landed, push the throttle stick down, and perform the same CSC used to start the motors. Release both sticks once the motors have stopped.



 • If the motor is started unexpectedly, use CSC to stop motors immediately.

Flight Test

Takeoff/Landing Procedures

1. Place the aircraft in an open, flat area with the aircraft rear facing towards the user.
2. Power on the remote controller and the aircraft.
3. Launch DJI Pilot 2 and enter the camera view.
4. Wait for the aircraft self-diagnostics to complete. If DJI Pilot 2 does not prompt any irregular warning, the user can start the motors.
5. Push the throttle stick up slowly to takeoff.
6. To land, hover over a level surface and push the throttle stick down to descend.
7. After landing, push the throttle down and hold. The motors will stop after three seconds.
8. Power off the aircraft before the remote controller.

Post-Flight Checklist:

- Make sure to perform a visual inspection so that the aircraft, remote controller, gimbal camera, Intelligent Batteries, and propellers are in good condition. Contact DJI support if any damage is noticed.
- Make sure that the camera lens and vision system sensors are clean.
- Make sure to store aircraft correctly before transporting it.

-
- ####
- Land the aircraft immediately at a safe location if prompted to do so in DJI Pilot 2.
 - Make sure to operate the aircraft within the transmission range of the remote controller. Otherwise, the remote controller and aircraft may be disconnected, and failsafe will be triggered (default setting is RTH). Press the RTH button on the remote controller to initiate RTH (default failsafe setting) instead of powering off the remote controller.
 - Tall buildings may adversely affect the failsafe function. Therefore, it is important to set an appropriate failsafe altitude before each flight. The RTH altitude is related to the Home Point. Make sure the RTH altitude is higher than any obstacle in the area.
 - The aircraft cannot avoid obstacles during failsafe RTH when there is insufficient light. Exit RTH and use the remote controller to control the aircraft when the remote controller signal is normal.
 - During RTH, continue to check the liveview and the aircraft altitude in case failsafe is disabled due to the GNSS signal being weak.
 - The Home Point can be updated manually. Make sure to avoid setting the Home Point inside or near a building to prevent collisions during RTH or landing.
 - Return to Home and land the aircraft if an ESC warning prompt appears in DJI Pilot 2 concerning temperature, voltage, or an overload. When Return to Home is initiated, pay attention to the flight status display in DJI Pilot 2 to ensure flight safety.
-

Appendix

Appendix

Specifications

Aircraft

Model	T740
Aircraft Weight	Approx. 3,995 g (includes gimbal camera, two batteries, lens, PROSSD, and propellers)
Max Takeoff Weight	4,310 g
Hovering Accuracy Range	Vertical: ± 0.1 m (with vision positioning) ± 0.5 m (with GNSS positioning) ± 0.1 m (with RTK positioning) Horizontal: ± 0.3 m (with vision positioning) ± 0.5 m (with GNSS positioning) ± 0.1 m (with RTK positioning)
RTK Positioning Accuracy (RTK fix)	1 cm + 1 PPM (horizontal) 1.5 cm + 1 PPM (vertical)
Max Angular Velocity	Pitch: 200°/s Roll: 200°/s Yaw: 150°/s
Max Tilt Angle	N Mode: 35° S Mode: 40° A Mode: 35° T Mode: 20° Emergency Brake: 55°
Max Ascent Speed ^[1]	8 m/s
Max Descent Speed ^[1]	Vertical: 8 m/s Tilt: 10 m/s
Max Horizontal Speed ^[1]	94 kph
Max Service Ceiling Above Sea Level ^[2]	Standard Propellers: 3800 m High-Altitude Propellers: 7000 m
Max Wind Resistance ^[3]	Takeoff/land: 12 m/s In-flight: 14 m/s
Max Hovering Time ^[4]	Approx. 25 minutes
Max Flight Time ^[5]	Approx. 28 minutes (landing gear lowered) Approx. 26 minutes (landing gear raised)
Motor Model	DJI 3511s
Global Navigation Satellite System	GPS + Galileo + BeiDou

Propeller Model	Standard Propellers: DJI 1671 High-Altitude Propellers: DJI 1676
Operating Temperature	-20° to 40° C (-4° to 104° F)
Diagonal Distance	Landing Gear Raised: 695 mm Landing Gear Lowered: 685 mm
Travel Mode Dimensions	Height: 176 mm Width: 709.8 mm Length: 500.5 mm
Gimbal Camera	
Sensor	35mm full-frame CMOS
Max Resolution	Photo: 8192×5456 Video: 8192×4320
Video Resolution	Refer to Recording Specifications
Supported Lens	DL 18mm F2.8 ASPH Lens DL 24mm F2.8 LS ASPH Lens DL 35mm F2.8 LS ASPH Lens DL 50mm F2.8 LS ASPH Lens
Photo Format	JPG, DNG
Video Format	MOV, CinemaDNG
Operation Mode	Capture, Record, Playback
Exposure Mode	P, A, S, M
Shutter Type	Electronic shutter
Shutter Speed	8-1/8000 s
White Balance	AWB MWB (2000K-10000K)
ISO Range	Photo ISO: 100-25600 Video EI: 200-6400
Anti-flicker	Capture Mode: Auto, 50 Hz, 60 Hz, OFF
Angular Vibration Range	Hovering: ±0.002° Flying: ±0.004°
Installation Method	Quick release
Mechanical Range	Tilt: -128° to +110° (landing gear lowered) -148° to +90° (landing gear raised) Roll: -90° to +230° Pan: ±330°

Controllable Range	<p>Tilt (landing gear lowered): Before gimbal pitch limit extension: -90° to $+30^{\circ}$ After gimbal pitch limit extension: -115° to $+100^{\circ}$</p> <p>Tilt (landing gear raised): Before gimbal limit extension: -90° to $+30^{\circ}$ After gimbal limit extension: -140° to $+75^{\circ}$</p> <p>Roll: $\pm 20^{\circ}$ Pan: $\pm 300^{\circ}$</p>
Max Control Speed	<p>With DJI RC Plus: Tilt: $120^{\circ}/s$ Roll: $180^{\circ}/s$ Pan: $270^{\circ}/s$</p> <p>With DJI Master Wheels: Tilt: $432^{\circ}/s$ Roll: $432^{\circ}/s$ Pan: $432^{\circ}/s$</p>
Weight	Approx. 516 g (without lens)
Video Transmission	
Video Transmission System	O3 Pro
Live View Quality	<p>FPV Camera: Up to 1080p/60fps Gimbal Camera: Up to 1080p/60fps, 4K/30fps</p>
Max Live Video Bitrate	50 Mbps
Max Transmission Distance ^[6]	<p>Single Control Mode: FPV Camera: approx. 15 km (FCC), 8 km (CE/SRRC/MIC) Gimbal Camera (1080p/60fps live feeds): approx. 13 km (FCC), 7 km (CE/SRRC/MIC) Gimbal Camera (4K/30fps live feeds): approx. 5 km (FCC), 3 km (CE/SRRC/MIC)</p> <p>Dual-Control Mode: FPV Camera: approx. 12 km (FCC), 6.4 km (CE/SRRC/MIC) Gimbal Camera (1080p/60fps live feeds): approx. 11.2 km (FCC), 5.6 km (CE/SRRC/MIC) Gimbal Camera (4K/30fps live feeds): approx. 4 km (FCC), 2.4 km (CE/SRRC/MIC)</p>
Lowest Latency ^[7]	<p>FPV Camera: 90 ms Gimbal Camera: 90 ms</p>
Operating Frequency ^[8]	<p>2.4000-2.4835 GHz 5.150-5.250 GHz (CE: 5.170-5.250 GHz) 5.725-5.850 GHz</p>
Transmitter Power (EIRP)	<p>2.4 GHz: <33 dBm (FCC), <20 dBm (CE/SRRC/MIC) 5.1 GHz: <23 dBm (CE) 5.8 GHz: <33 dBm (FCC), <30 dBm (SRRC), <14 dBm (CE)</p>
Battery	
Model	TB51 Intelligent Battery

Capacity	4280 mAh
Nominal Voltage	23.1 V
Type	Li-ion
Chemical System	LiCoO2
Energy	98.8 Wh
Weight	Approx. 470 g
Operating Temperature	-20° to 40° C (-4° to 104° F)
Charging Temperature ^[9]	-20° to 40° C (-4° to 104° F)
Max Charging Power	411 W
Charge via Aircraft	Not supported
Battery Charging Hub	
Input	100-240 V AC, max 8 A
Output	26.4 V, 7.8 A
Total Rated Output	476 W, including 65W PD fast charging of USB-C port
Charging Time ^[10]	Fast Mode: Approx. 35 minutes to 90% Standard Mode: Approx. 55 minutes to 100% Silent Mode: Approx. 80 minutes to 100%
Charging Temperature	-20° to 40° C (-4° to 104° F)
Weight	Approx. 1,680 g
Memory Card	
Memory Card Type	DJI PROSSD 1TB
Sensing	
Forward	Measurement Range: 1.5-48 m Effective Sensing Speed: ≤15 m/s FOV: Horizontal 90°, Vertical 103° (landing gear raised) Horizontal 72°, Vertical 103° (landing gear lowered)
Backward	Measurement Range: 1.5-48 m Effective Sensing Speed: ≤15 m/s FOV: Horizontal 90°, Vertical 103°
Lateral	Measurement Range: 1.5-42 m Effective Sensing Speed: ≤15 m/s FOV: Horizontal 90°, Vertical 85°
Upward	Measurement Range: 0.2-13 m Effective Sensing Speed: ≤6 m/s FOV: Front and Back 100°, Left and Right 90°
Downward	Measurement Range: 0.3-18 m Effective Sensing Speed: ≤6 m/s FOV: Front and Back 130°, Left and Right 160°

Operating Environment ^[11]	Forward, Backward, Left, Right and Upward: surfaces with discernible patterns and adequate lighting (lux >15) Downward: surfaces with discernible patterns and diffuse reflectivity >20% (e.g., walls, trees, people); adequate lighting (lux >15)
---------------------------------------	---

ToF Infrared Sensor Measurement Range 0-10 m

Remote Controller

Model	RM700B
Operating Time	Built-in Batteries: approx. 3.3 hours Built-in Batteries Plus External Battery: approx. 6 hours
Operating Frequency ^[8]	2.4000-2.4835 GHz 5.725 GHz-5.850 GHz
Video Output Port	HDMI
Power Supply	Built-in batteries or external battery
Coordinated Operation	Supports dual controls and coordination between multiple operators
Power Consumption	12.5 W
Operating Temperature	-20° to 50 °C (-4° to 122° F)
Storage Temperature	-30° to 45° C (-22° to 113° F) (within one month) -30° to 35° C (-22° to 95° F) (one to three months) -30° to 30° C (-22° to 86° F) (three months to one year)
Battery	Built-in Battery: 3250mAh-7.2V (a set) External Battery: WB37 Intelligent Battery
Wi-Fi Protocol	Wi-Fi 6
Wi-Fi Operating Frequency	2.4000-2.4835 GHz 5.150-5.250 GHz 5.725-5.850 GHz
Wi-Fi Transmitter Power (EIRP)	2.4 GHz: <26 dBm (FCC), <20 dBm (CE/SRRC/MIC) 5.1 GHz: <26 dBm (FCC), <23 dBm (CE/SRRC/MIC) 5.8 GHz: <26 dBm (FCC/SRRC), <14 dBm (CE)
Bluetooth Protocol	Bluetooth 5.1
Bluetooth Operating Frequency	2.4000-2.4835 GHz
Bluetooth Transmitter Power (EIRP)	< 10 dBm
App	
App	DJI Pilot 2
FPV Camera	
FOV	161°
Resolution	1920×1080@60fps

- [1] Measured when flying in a windless environment at sea level, with gimbal camera and lens attached to the aircraft and without other accessories. This data is for reference only.
- [2] Measured in an environment with light wind with the gimbal camera and lens attached to the aircraft and without other accessories. This data is for reference only.
- [3] Measured when flying at sea level, with gimbal camera and lens attached to the aircraft and without other accessories. This data is for reference only.
- [4] Measured when hovering in a windless environment at sea level with gimbal camera and lens attached to the aircraft and without other accessories, with landing gear raised, and recording 4K/24fps H.264 (S35) video until the battery reached 0%. This data is for reference only. Please refer to the actual values in the app.
- [5] Measured when flying forward at a constant speed of 36 kph in a windless environment at sea level, with gimbal camera and lens attached to the aircraft and without other accessories, and recording 4K/24fps H.264 (S35) video until the battery reached 0%. This data is for reference only. Please refer to the actual values in the app.
- [6] Measured in an unobstructed outdoor environment free of interference, with gimbal camera and lens attached to the aircraft and without other accessories. The above data shows the farthest communication range for one-way, non-return flights under each standard. During your flight, please pay attention to reminders in the app.
- [7] The lowest latency of the gimbal camera was measured when recording 4K/60fps ProRes RAW video. The lowest latency of the FPV camera was measured with strong video transmission signals.
- [8] In some countries and regions, the 5.1 and 5.8GHz frequencies are prohibited, or the 5.1GHz frequency is only allowed for indoor use. Please refer to local laws and regulations.
- [9] If the temperature of the battery is lower than 10° C (50° F), the battery will trigger an auto-heating function. Charging in a low-temperature environment below 0° C (32° F) may shorten battery life.
- [10] Tested at a room temperature of 25° C (77° F) and in a well-ventilated environment. In Fast mode, each battery pair is charged to 90% in sequence, and then eight batteries are charged together to 100%.
- [11] Obstacle sensing is disabled while the landing gear is in the process of being raised or lowered.

Recording Specifications

Codec	Fov	Sensor Resolution		Sensor FPS/Rate																	
				23.976	24	25	29.97	30	48	50	59.94	60	* Choose after enabling S&Q mode								
													72	75	96	100	119.88	120			
Cinema DNG	FF	8192×4320	17 : 9	849MBps	849MBps	885MBps															
		7680×4320	16 : 9	796MBps	796MBps	829MBps															
		4096×2160	17 : 9	212MBps	212MBps	221MBps	265MBps	265MBps	425MBps	442MBps	531MBps	531MBps	637MBps	663MBps	849MBps	885MBps					
		3840×2160	16 : 9	199MBps	199MBps	207MBps	249MBps	249MBps	399MBps	415MBps	498MBps	498MBps	597MBps	872MBps	796MBps	829MBps					
	S35	5568×2952	17 : 9	394MBps	394MBps	411MBps	493MBps	493MBps	789MBps	822MBps											
		5248×2952	16 : 9	372MBps	372MBps	387MBps	465MBps	465MBps	744MBps	775MBps											
ProRes RAW	FF	8192×4320	17 : 9	425MBps	425MBps	442MBps	265MBps	265MBps	425MBps	442MBps	531MBps	531MBps									
		7680×4320	16 : 9	398MBps	398MBps	415MBps	249MBps	249MBps	398MBps	415MBps	498MBps	498MBps									
		8192×3424	2.39 : 1										505MBps	526MBps							
		4096×2160	17 : 9	106MBps	106MBps	111MBps	133MBps	133MBps	212MBps	221MBps	265MBps	265MBps	319MBps	332MBps	425MBps	442MBps	265MBps	265MBps			
	S35	3840×2160	16 : 9	100MBps	100MBps	104MBps	124MBps	124MBps	199MBps	207MBps	249MBps	249MBps	299MBps	311MBps	398MBps	415MBps	249MBps	249MBps			
		5568×2952	17 : 9	198MBps	198MBps	206MBps	247MBps	247MBps	395MBps	412MBps	494MBps	494MBps									
		5248×2952	16 : 9	186MBps	186MBps	194MBps	232MBps	232MBps	372MBps	387MBps	465MBps	465MBps									
ProRes 422 HQ	FF	8192×4320	17 : 9	377MBps	377MBps	393MBps	471MBps	471MBps													
		7680×4320	16 : 9	352MBps	352MBps	396MBps	442MBps	442MBps													
		4096×2160	17 : 9	94MBps	94MBps	98MBps	118MBps	118MBps	189MBps	197MBps	236MBps	236MBps	283MBps	295MBps	377MBps	393MBps	471MBps	471MBps			
		3840×2160	16 : 9	88MBps	88MBps	92MBps	111MBps	111MBps	177MBps	184MBps	221MBps	221MBps	265MBps	265MBps	354MBps	369MBps	442MBps	442MBps			
	S35	4096×2160	17 : 9	94MBps	94MBps	98MBps	118MBps	118MBps	189MBps	197MBps	236MBps	236MBps									
		3840×2160	16 : 9	88MBps	88MBps	92MBps	111MBps	111MBps	177MBps	184MBps	221MBps	221MBps									
H.264	FF	4096×2160	17 : 9	19MBps	19MBps	19MBps	19MBps	19MBps	26MBps	26MBps	26MBps	26MBps	38MBps	38MBps	38MBps	38MBps	38MBps	38MBps	38MBps		
		3840×2160	16 : 9	19MBps	19MBps	19MBps	19MBps	19MBps	26MBps	26MBps	26MBps	26MBps	38MBps	38MBps	38MBps	38MBps	38MBps	38MBps	38MBps		
	S35	4096×2160	17 : 9	19MBps	19MBps	19MBps	19MBps	19MBps	26MBps	26MBps	26MBps	26MBps									
		3840×2160	16 : 9	19MBps	19MBps	19MBps	19MBps	19MBps	26MBps	26MBps	26MBps	26MBps									

Firmware Update

Use DJI Pilot 2 or DJI Assistant 2 (Inspire Series) to update the remote controller, aircraft, and other connected DJI devices.

Using DJI Pilot 2

Aircraft and Remote Controller

1. Power on the aircraft and remote controller. Ensure the aircraft is linked to the remote controller, the battery level is higher than 25%, and the remote controller is connected to the internet.
2. Run DJI Pilot 2. A prompt will appear on the homepage if new firmware is available. Tap to enter the Firmware Update page.
3. Tap Update All, and DJI Pilot 2 will download the firmware and update the aircraft and remote controller.
4. The aircraft and remote controller will automatically restart after the firmware update is completed.

-
- ⚠** • Make sure the remote controller battery level is higher than 25% before updating. The update takes approximately 15 minutes (depending on network strength). Make sure the remote controller is connected to the internet during the update.
- The gimbal camera and the TB51 Intelligent Batteries inserted into the aircraft will be updated to the latest firmware version.
-

Charging Hub and Intelligent Batteries

Use the DJI Pilot 2 app to update the firmware of the battery hub as well as up to eight TB51 Batteries at the same time.

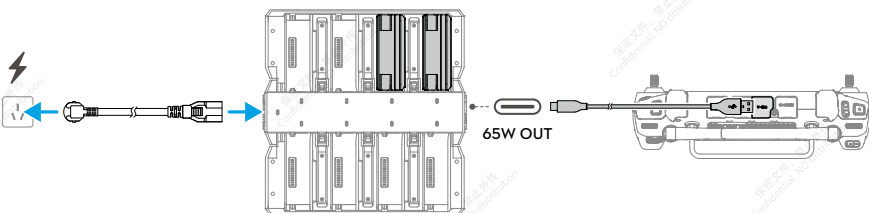

1. Insert the TB51 batteries into the battery ports and supply power of the charging hub.
2. Connect the charging hub USB-C port to the remote controller USB-A port using a USB-C to USB-A data cable.
3. Power on the remote controller and make sure it is connected to the internet.
4. Run DJI Pilot 2. If a version update is available, the homepage will prompt that the charging hub firmware update is required. Tap the prompt to enter the charging hub update page.

5. Tap Update All to begin the update, which takes approximately 10 minutes. The update is completed when the update success prompt appears.

-
-  • During a firmware update, DO NOT insert or remove the batteries to avoid battery update failure.
- During a firmware update, DO NOT unplug the USB-C to USB-A data cable to avoid firmware update failure.
-

Using DJI Assistant 2 (Inspire Series)

DJI Assistant 2 (Inspire Series) supports the updating of the remote controller and aircraft but not the charging hub. Use the DJI Pilot 2 app to update the charging hub.

Aircraft and Remote Controller

1. Connect the remote controller or aircraft to the USB-A port of the PC with a USB-C to USB-A data cable one by one, as the assistant software does not support the updating of multiple DJI devices at the same time.
2. Make sure the computer is connected to the internet and the DJI device is powered on with a battery level higher than 25%.
3. Run the assistant software, log in with your DJI account, and enter the main view.
4. Tap the firmware update button on the left side.
5. Select the firmware version and click to update. The firmware will be downloaded and updated automatically.
6. The DJI device will restart automatically, when the Update Successful prompt appears and the device update is completed.

-
-  • The battery firmware is included in the aircraft firmware. Be sure to update all batteries.
- Make sure that the battery levels of the aircraft and remote controller are higher than 25% before updating.
 - Make sure the DJI devices are connected properly to the computer during an update.
 - During the update process, it is normal for the gimbal to go limp, the aircraft LED indicators to blink, and the aircraft to reboot. Wait for the update to complete.
 - Make sure to keep the aircraft away from people and animals during a firmware update, system calibration, or parameter configuration.
 - For safety, make sure you are using the latest firmware version.
 - After the firmware update is completed, the remote controller and the aircraft may become disconnected. Reconnect the devices if necessary.
 - DO NOT use other Hardware and Software than specified by the manufacturer.
-

Storage and Transportation and Maintenance

- DO NOT store the product in a humid or dusty area. Ideally, the aircraft shall be stored in a cool and dry place at room temperature of 25° C (77° F), and direct sunlight shall be avoided.
- DO NOT store the gimbal camera in humid or dusty areas. The recommended environmental humidity range is 20-90% RH.
- The storage temperature of the product (excluding TB51 Intelligent Batteries) is from -35° to 40° C (-31° to 104° F).
- Remove the gimbal camera from the aircraft when storing or transporting for an extended period. Otherwise, the gimbal damper may be damaged.
- Make sure the aircraft is in travel mode when transporting. It is recommended to use the trolley case whenever transporting the aircraft.
- It is recommended to perform regular maintenance for aircraft. Check every part of the aircraft after any crash or collision. If you have any problems or questions, please contact DJI Support or a DJI authorized dealer.
- Maintain the product after using for an extended period in order to keep the product in the best condition possible and reduce potential safety hazards. The frequency of how often maintenance should be performed depends on how often the product is used. Maintenance must be performed at least once every six months. The regular life of the transformation mechanism is more than 3 years. The internal gear box and grease of the steering gear supporting to raise or lower the landing gear will have a certain degree of wear and consumption in approximately six months. So it is normal that the sound during transformation becomes louder after time. If there are any problems or questions, contact DJI Support to purchase and replace.
- DO NOT lubricated the aircraft frame arms.
- DO NOT touch the dust-proof cover outside the screw rod.
- DO NOT lubricated the hinge.
- Refer to the maintenance manual for more information.

Trolley Case

Using the Trolley Case for Storage

Regular Storage: the status of the product out of box is as below.

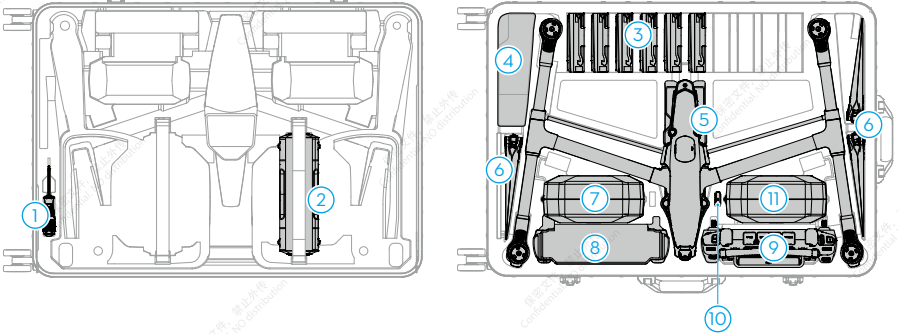

1. Screwdriver
2. Changing Hub (bind belts when placed)
3. Intelligent Batteries
4. Remote Controller Strap/Documents
5. Aircraft Body
6. Foldable Quick-Release Propellers
7. Gimbal Camera Box (included gimbal camera)
8. Cables/Gimbal Dampers
9. Remote Controller
10. DJI PROSSD
11. Lens Box

Storing the Aircraft Mounted with Propellers: the aircraft mounted with propellers storage is only suitable for temporary transfers. Make sure to store it according to the diagram below to avoid propeller or trolley case damage. For long-term storage, it is recommended to remove and fold the propeller, and place it in the corresponding storage compartment of the trolley case.

Storing the Gimbal Camera and the Lens Boxes: place them into the trolley case and bind the belts.

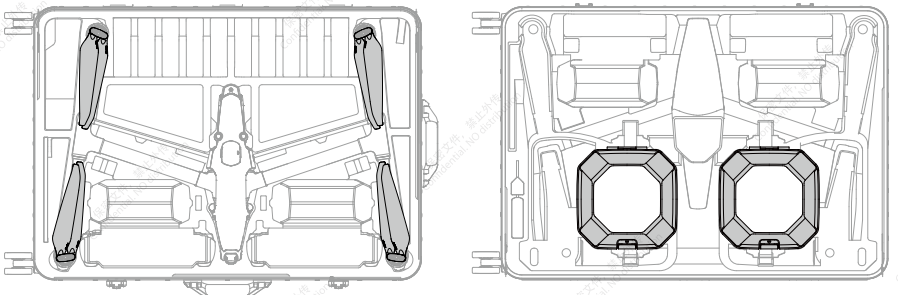

- After storing the gimbal camera and the lens boxes, the charging hub cannot be placed in the trolley case.

Trolley Case Lock

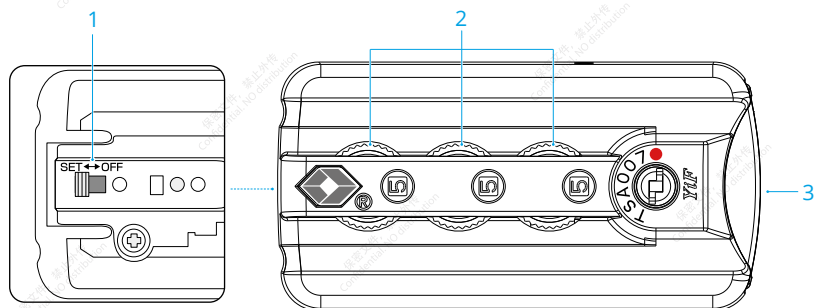

1. Resettable Switch
2. Dials
3. Button

Setting the Combination Code

The combination code is original 000. Follow the steps below to reset the combination code:

1. Toggle the resettable switch on the rear of the lock to SET.
2. Adjust the dials to the set a personal combination code.
3. Toggle the resettable switch to OFF to finish setting.
4. Make sure to memorize the new combination code well.

Using the Combination Code

1. Adjust the dials to the correct numbers and press the button to open the lock.
2. Press down the lock and adjust the dials to the numbers randomly to lock the trolley case.

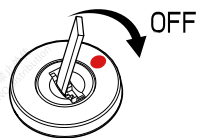

If the lock cylinder is opened, use a tool to turn it to the red dot position by the direction of the arrow to lock it again.

💡 Any tool that can be inserted in the lock cylinder is OK.

Troubleshooting Procedures

1. Why can the battery not be used before the first flight?
The battery must be activated by charging before using it for the first time.
2. How to solve the gimbal drift issue during flight?
Calibrate IMU and compass in DJI Pilot 2. If the problem persists, contact DJI Support.
3. No function
Check if the Intelligent Batteries and the remote controller are activated by charging. If the problems persist, contact DJI Support.
4. Power-on and start-up problems
Check if the battery has power. If yes, contact DJI Support if it cannot be started normally.
5. SW update issues
Follow the instructions in the user manual to update the firmware. If the firmware update fails, restart all the devices and try again. If the problem persists, contact DJI Support.
6. Procedures to reset to factory default or last known working configuration
Use the DJI Pilot 2 app to reset to factory default.
7. Shutdown and power-off problems
Contact DJI Support.
8. How to detect careless handling or storage in unsafe conditions
Contact DJI Support.

Risk and Warnings

When the aircraft detects a risk after powering on, there will be a warning prompt on DJI Pilot 2.

Pay attention to the list of situations below.

1. If the location is not suitable for takeoff.
2. If an obstacle is detected during flight.
3. If the location is not suitable for landing.
4. If the compass and IMU experience interference and need to be calibrated.
5. Follow the on-screen instructions when prompted.

Disposal

Observe the local regulations related to electronic device when dispose the aircraft and remote controller.



Battery Disposal

Dispose of the batteries in specific recycling containers only after a complete discharge. DO NOT dispose of the batteries in regular trash containers. Strictly follow the local regulations regarding the disposal and recycling of batteries.

Dispose of a battery immediately if it cannot be powered on after over-discharging.

If the battery level button on the battery is disabled and the battery cannot be fully discharged, contact a professional battery disposal/recycling agency for further assistance.

C3 Certification

Inspire 3 is complied with C3 certification, there are some requirements and restrictions when using Inspire 3 in European Economic Area (EEA, i.e. EU plus Norway, Iceland and Liechtenstein).

UAS Class	C3
Sound Power Level	98 dB(A)
Maximum Propeller Speed	7100 RPM
Maximum Dimensions (with payload installed and propellers rotating)	Landing gear raised: 860.7×927.71×508.85 mm Landing gear lowered: 860.7×927.71×508.85 mm

MTOM Statement

The MTOM of Inspire 3 (Model T740), including two batteries, gimbal camera, lens (with balancing ring and hood), DJI PROSSD and four propellers, is not larger than 4310 g to comply with C3 requirement.

Users must follow the instructions below to comply with the MTOM C3 requirements. Otherwise, the aircraft cannot be used as a C3 UAV:

1. DO NOT add any other payload to the aircraft, make sure that the MTOM is not larger than 4310 g for any flight.
2. DO NOT use any non-qualified replacement parts, such as intelligent batteries or propellers, etc.
3. DO NOT retrofit the aircraft.

Direct Remote ID

1. Transport Method: Wi-Fi Beacon.
2. Method of uploading the UAS Operator Registration Number to the aircraft: Enter DJI Pilot 2 > GEO Zone Map > UAS Remote Identification, and then upload UAS Operator Registration Number.

List of Items, Including Qualified Accessories

Part	Weight	Dimension
Zenmuse X9-8K Air Gimbal Camera	Approx.516 g	127.5×120.6×156.0 mm
DL 18mm F2.8 ASPH Lens	Approx. 182 g	Φ64.5×62.8 mm
DL 24mm F2.8 LS ASPH Lens	Approx. 178 g	Φ55.0×71.2 mm
DL 35mm F2.8 LS ASPH Lens	Approx. 179 g	Φ55.0×71.2 mm
DL 50mm F2.8 LS ASPH Lens	Approx. 182 g	Φ55.0×71.2 mm
DL Lens ND4 Filter (Φ46mm)	Approx. 9 g	Φ46 mm
DL Lens ND8 Filter (Φ46mm)	Approx. 9 g	Φ46 mm
DL Lens ND16 Filter (Φ46mm)	Approx. 9 g	Φ46 mm
DL Lens ND32 Filter (Φ46mm)	Approx. 9 g	Φ46 mm
DL Lens ND64 Filter (Φ46mm)	Approx. 9 g	Φ46 mm
DL Lens ND128 Filter (Φ46mm)	Approx. 9 g	Φ46 mm
Balancing Ring	Approx. 9 g	Φ46 mm
DL Lens Protector (Φ46mm)	Approx. 9 g	Φ46 mm
Inspire 3 Foldable Quick-Release Propeller	Approx. 12.7 g	40.6×18 cm
PROSSD 1TB	Approx. 45.5 g	96×29.4×10.3 mm
TB51 Intelligent Battery	Approx.470 g	117.3×90×33.3 mm
TB51 Intelligent Battery Charging Hub	Approx.1680 g	84×97×243.1 mm (folded)

List of Spare and Replacement Parts

Inspire 3 Foldable Quick-Release Propellers (Pair) (Model: DJI 1671)

TB51 Intelligent Battery (Model: TB51-4280-23.1)

Remote Controller Warnings

The remote controller indicator will glow red after disconnecting from the aircraft for more than two seconds.

DJI Pilot 2 will prompt a warning after disconnecting from the aircraft.

There will be an alert if the remote controller is not used for five minutes while it is powered on but the touchscreen is off and it is not connected to the aircraft. It will automatically power off after a further 30 seconds. Move the control sticks or perform any other remote controller action to cancel the alert.

- Avoid interference between the remote controller and other wireless device. Make sure to turn off the Wi-Fi on nearby mobile devices. Land the aircraft as soon as possible if there is interference.
- DO NOT operate the aircraft if lighting conditions are too bright or dark when using a remote controller to monitor the flight. Users are responsible for correctly adjusting the display brightness when using the remote controller in direct sunlight during flight operation.
- Release the control sticks or press the flight pause button if an unexpected operation occurs.

Firmware Version Information

Aircraft Firmware	v01.00.00.10
Remote Controller Firmware	v01.04.03.00
TB51 Intelligent Battery	v04.01.00.51
DJI Pilot 2	v5.0.1.10

Refer to the Inspire 3 Release Notes for more firmware update information for traceability.
www.dji.com/inspire-3/downloads

GEO Awareness

Drone Geo-Zones and DJI Geo Zones

DJI is committed to maintaining a safe flying environment. This includes abiding by local regulations and Unmanned Geographical Zones (UGZs) defined by EU national authorities. DJI has its own Geospatial Environment Online system (GEO) with broader geographical zones, including regulated areas where flight may raise concerns. DJI's GEO system has been running successfully for many years, effectively protecting flight safety and public safety in the absence of official UGZ databases.

In the future, DJI Geo zones will coexist with EU UGZs, as UGZs are still not available in many countries. Users are responsible for checking local regulations and for any flight restrictions where they intend to operate.

The GEO zones mentioned in the manual and DJI official website refers to the DJI Geo zones and Geo fencing function, not the UGZs for Geo awareness function required by regulations.

AGL (Above Ground Level) Statement

The vertical limits of Geo-awareness may use the AMSL altitude or the AGL height. The choice between these two references is specified individually for each UGZ. Neither AMSL altitude nor the AGL height is supported by this product. H (Height) appears in the app camera view, which is the height from the aircraft takeoff point to the aircraft. The height above the takeoff point may be used as an approximation but may differ more or less from the given altitude/height for a specific UGZ. The remote pilot remains responsible for not breaching the vertical limits of the UGZ.

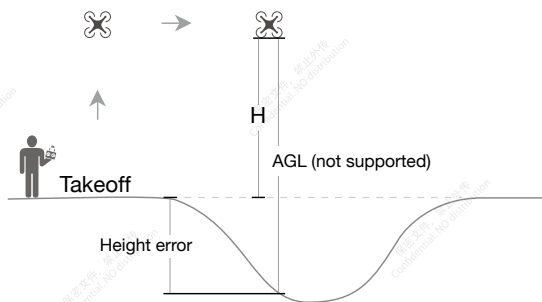

DJI Geo Zones with Geo Fencing Function

DJI Geo zones are divided into seven categories with only five of them taking effect. If more than one restriction is set at the same position, the alert generated is in the following order:

Restricted Zones > Authorization Zones > Altitude Zones > Enhanced Warning Zones > Warning Zones

Restricted Zones

Appear red in the DJI app. Users will be prompted with a warning message, and flight is prevented. UA (Unmanned Aircraft) cannot fly or takeoff in these zones. Restricted Zones may be unlocked, to unlock contact flysafedji.com or go to Unlock A Zone at <https://fly-safe.dji.com/>.

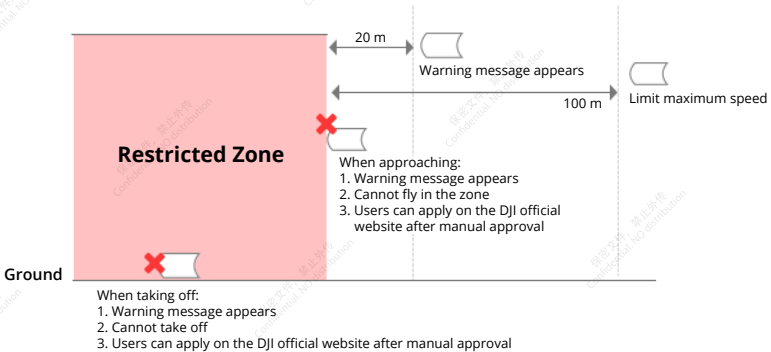

Authorization Zones

Appear blue in the app. Users will be prompted with a warning message, and flight is limited by default. UA cannot fly or takeoff in these zones unless authorized. Authorization Zones may be unlocked by authorized users using a DJI verified account.

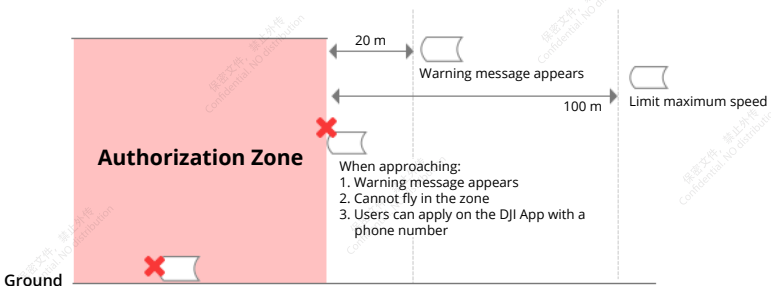

Altitude Zones

Altitude zones are zones with a limited altitude and appear in gray on the map. When approaching, users will receive a warning message in the app.

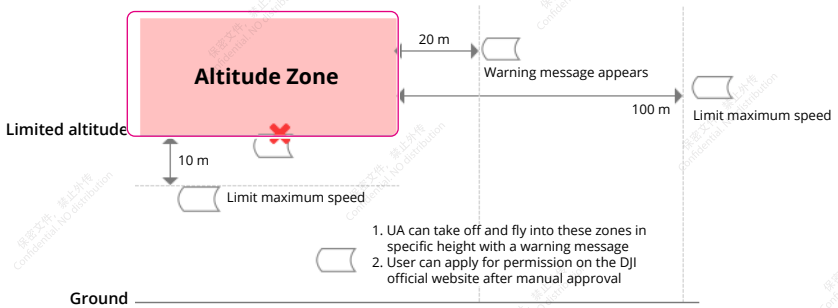

Enhanced Warning Zones

A warning message will prompt users when the drone reaches the edge of the zones.



Warning Zones

A warning message will prompt users when the drone reaches the edge of the zones.

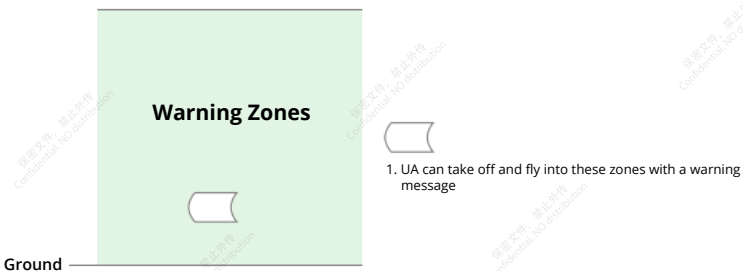

Regulatory Restricted Zones

Due to local regulations and policies, flights are prohibited within the scope of some special areas. (Example: Prisons)

Approved Zones for Light UAVs (China):

For Approved Zones, pilots of light UAVs flying at an altitude of 120 m or less are not required to obtain permission to fly. Pilots who are planning to fly medium-sized UAVs in Approved Zones at an altitude higher than 120 m, or in GEO Zones other than Approved Zones, must obtain permission via UTMIS before taking off.

UGZ Zone for Geo-awareness function

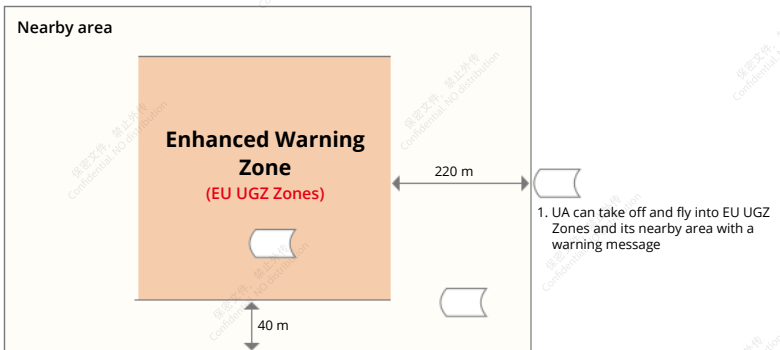

EASA Notice

Make sure to read the Drone Information Notices document included in the package before use.

Go to the address below for more EASA notice information for traceability.

<https://www.easa.europa.eu/en/document-library/general-publications/drones-information-notices>

Original Instructions

This manual is provided by SZ DJI Technology, Inc., and the content is subject to change. Lobby of T2, DJI Sky City, No. 53 Xianyuan Road, Xili Community, Xili Street, Nanshan District, Shenzhen, China, 518057.

FAR Remote ID Compliance Information

The aircraft complies with the requirements of 14 CFR Part 89:

- The aircraft automatically initiates a pre-flight self-test (PFST) of the Remote ID system before takeoff and cannot take off if it does not pass the PFST^[1]. The results of the PFST of the Remote ID system can be viewed in a DJI flight control app such as DJI Pilot 2.
- The aircraft monitors the Remote ID system functionality from pre-flight to shut down. If the

Remote ID system malfunctions or has a failure, an alarm information will be displayed in a DJI flight control app such as DJI Pilot 2.

- The user shall keep the DJI flight control app running in the foreground and always allow it to obtain the location information of the remote controller.
- [1] The pass criterion for PFST is that the hardware and software of the Remote ID required-data source and transmitter radio in the Remote ID system are functioning properly.

After-Sales Information

Visit <https://www.dji.com/support> to learn more about after-sales service policies, repair services, and support.

WE ARE HERE FOR YOU



Contact
DJI SUPPORT

This content is subject to change.

<https://www.dji.com/inspire-3/downloads>

If you have any questions about this document, please contact DJI by sending a message to DocSupport@dji.com.

DJI and INSPIRE are trademarks of DJI.
Copyright © 2023 DJI All Rights Reserved.