

KUMO[®] Compact SDI Routers

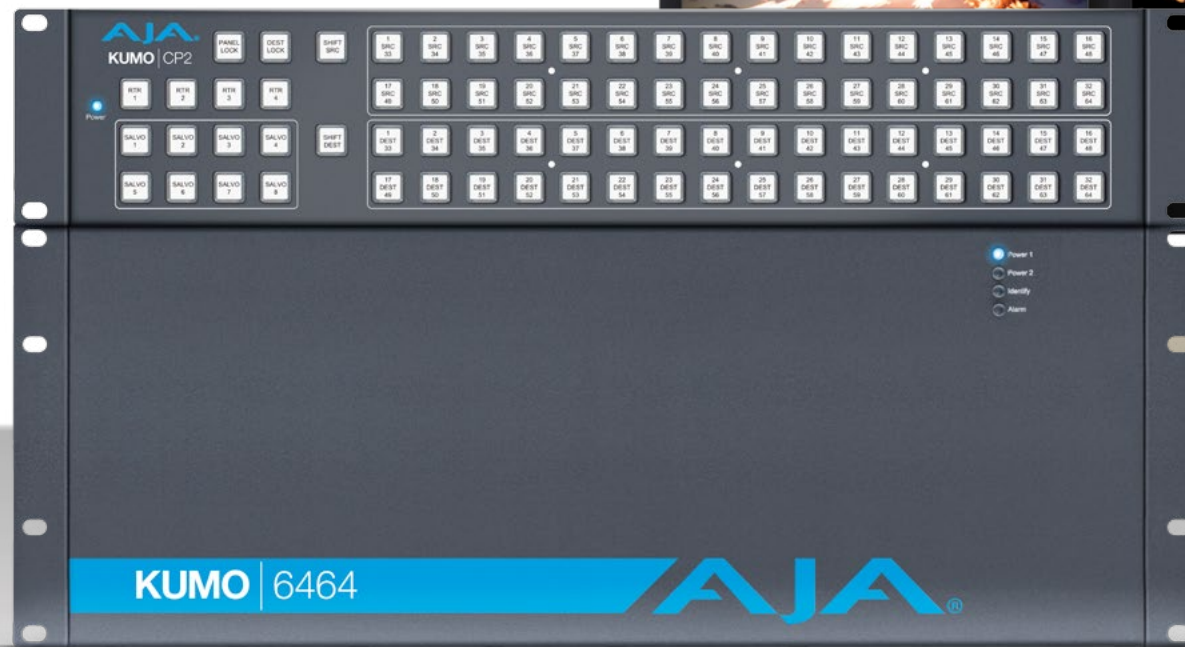

KUMO®



Compact SDI Routers

Compact, robust and built for critical environments, KUMO 3G-SDI routers offer flexibility and quality that exceeds SMPTE specifications at an unprecedented price.

AJA's KUMO family of compact SDI routers provide high quality signal control that is ideal for small facilities or space sensitive locations.

Cost effective, without compromising power or flexibility, KUMO compact SDI routers provide powerful signal control and support full broadcast specifications over 3G-SDI, with quality that exceeds SMPTE specifications. The super compact 1RU, 2RU and 4RU sizes are just a few inches deep, making them a perfect fit for any broadcast, production, or post production environment.

Running embedded Linux®, KUMO routers are network ready and support full HTTP control and monitoring. KUMO's internal web server allows immediate installation, configuration, and operation with standard web browsers - so there's no need to purchase or install any additional software. The new optional 2RU networkable control panel (KUMO CP2) can control all KUMOs, including the KUMO 6464, in stand-alone or networked configurations enabling comprehensive control without the need of a computer.

KUMO routers are easily integrated with existing infrastructure utilizing the REST API, the industry standard Grass Valley Native Protocol over RS-422 or even Ethernet. Ethernet network connectivity allows you to control KUMO routers from any web browser on a network connected device, ensuring you have the control you need.

As 4K/UltraHD workflows continue to gain ground, KUMO routers can meet the rising challenge. With a simple setting change, KUMO routers can be configured for ganged dual and quad port routing, allowing users to group together multiple inputs and outputs for dual-link, 4K/UltraHD workflows. This allows routing of uncompressed or raw 4K/UltraHD signals throughout a production or post facility. Then switch the router back to 2K/HD/SD operation as needed, giving you the flexibility to route virtually any format in your facility.

Eight Salvos can be configured and stored in a KUMO router. Salvos allow the operator to quickly recall predefined sources to specific destinations configurations with a simple button press.

KUMO SDI routers are available in four configurations: 16x4, 16x16, 32x32 and 64x64.

KUMO compact SDI routers offer AJA reliability, flexibility and uncompromising signal quality, all at an unprecedented price. Built to the exacting standards of all AJA hardware, KUMO products are backed by our world class support network, five year international warranty and advanced exchange service.



Compact Routing

Just 1RU, 2RU or 4RU high and less than 2" deep, KUMO fits in the most space constrained locations, offering flexible routing with support for 3G-SDI I/O that exceeds SMPTE specifications.

The powerful crosspoint routing matrix allows the mapping of any input to any output. Signals can also be sent to multiple outputs without the need for additional patch panels or distribution amplifiers.

Designed for critical broadcast, production and post environments, KUMO hardware uses premium components coupled with dual redundant power supplies to ensure uptime in the unlikely event of a power supply failure.



Simple Configuration

Running embedded Linux, KUMO routers are network ready and support powerful HTTP control and monitoring via a web browser without the need for any additional software.

KUMO's auto-detect Bonjour®/Zeroconf protocols mean that network configuration is automatic, just connect KUMO to your network and the system will self configure, ready for use. Alternatively, standard network configuration allows access to each KUMO via its assigned IP address. Once connected to KUMO using a web browser, you can configure the full TCP/IP settings, select and name KUMO routers, name sources and destinations, and perform all operational functions.



KUMO Control Panels

KUMO CP2 offers 32 source and 32 destination buttons for direct access to all KUMO inputs and outputs in the range up to KUMO 3232 and for KUMO 6464, a shift key provides access to the next 32. New Salvos support simplifies switching operations by recalling multiple sources to specific destinations. Salvos are stored in the KUMO router and can be recalled via the KUMO router's Web UI, Grass Valley Native Protocol over Ethernet, RS-232, and/or the AJA KUMO CP2 Salvos buttons.

Connecting via Ethernet to the same network as KUMO routers, KUMO CPs enable full control from any location and up to four KUMO routers can be controlled from a single control panel. For stand-alone configurations, KUMO hardware can be connected directly via RJ-45 cables and KUMO software will automatically assigns routers to control panel delegations.





KUMO 1604

KUMO 1604 is the right size for typical AV setups or corporate meetings where several different cameras, computers or other video devices need to be routed to a few monitors or projectors.

\$1,395 US MSRP*



KUMO 1616

For medium sized facilities and mobile trucks, KUMO 1616 is just the right size for combining multiple cameras, monitors, editing systems, tape decks and file based recorders into a seamless workflow.

\$1,995 US MSRP*



KUMO 3232

As your routing needs grow, KUMO 3232 has the additional capacity you require, making it perfect for larger environments and high density applications.

\$3,495 US MSRP*



KUMO 6464

KUMO 6464 offers an incredible 64 inputs and 64 outputs of 3G-SDI video and embedded audio, while maintaining a slim and compact 4RU profile for any SDI based signal up to 3G-SDI, including HD and even 4K/UltraHD signals (quad mode).

\$7,995 US MSRP*



KUMO CP

KUMO CP is an optional 1RU control panel that can be used in stand-alone or networked configurations for KUMO 1604, KUMO 1616 and KUMO 3232.

\$595 US MSRP*



KUMO CP2

KUMO CP2 is an optional 2RU control panel that can be used in stand-alone or networked configurations for all KUMO routers.

\$895 US MSRP*

[Find a Reseller](#)

Control Panel Connections

KUMO Control Panel



[Click here](#)

For full product specifications visit www.aja.com/en/products/kumo-cp/#techspecs

Control Panel 2 Connections

KUMO Control Panel 2



[Click here](#)

For full product specifications visit www.aja.com/en/products/kumo-cp2/#techspecs

1604 Connections

KUMO 1604

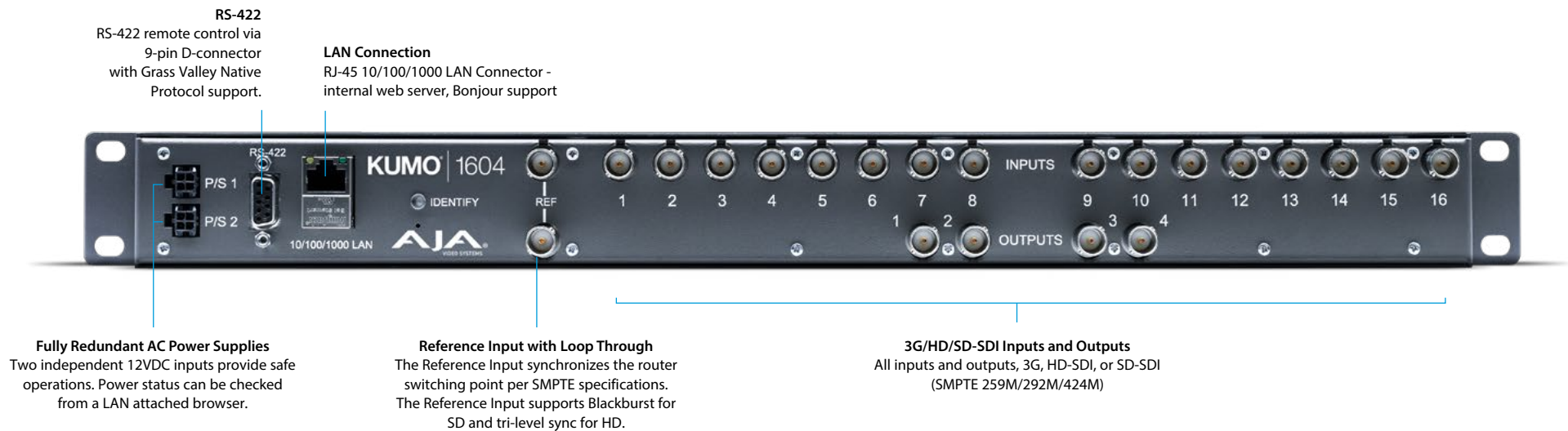

[Click here](#)

For full product specifications visit www.aja.com/en/products/kumo-1604/#techspecs

1616 Connections

KUMO 1616

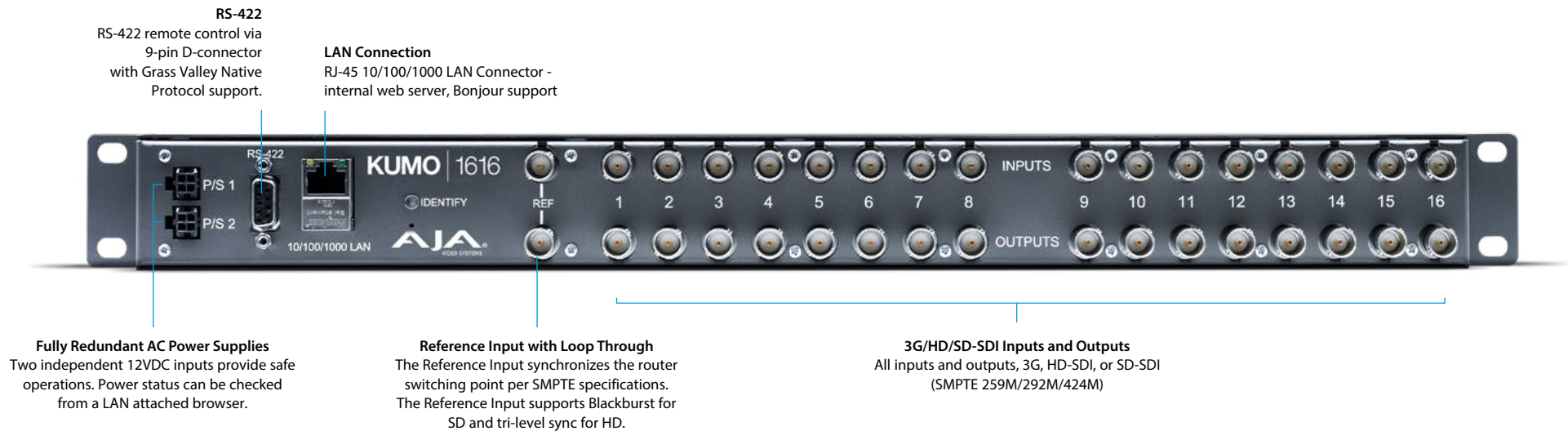

[Click here](#)

For full product specifications visit www.aja.com/en/products/kumo-1616/#techspecs

3232 Connections

KUMO 3232

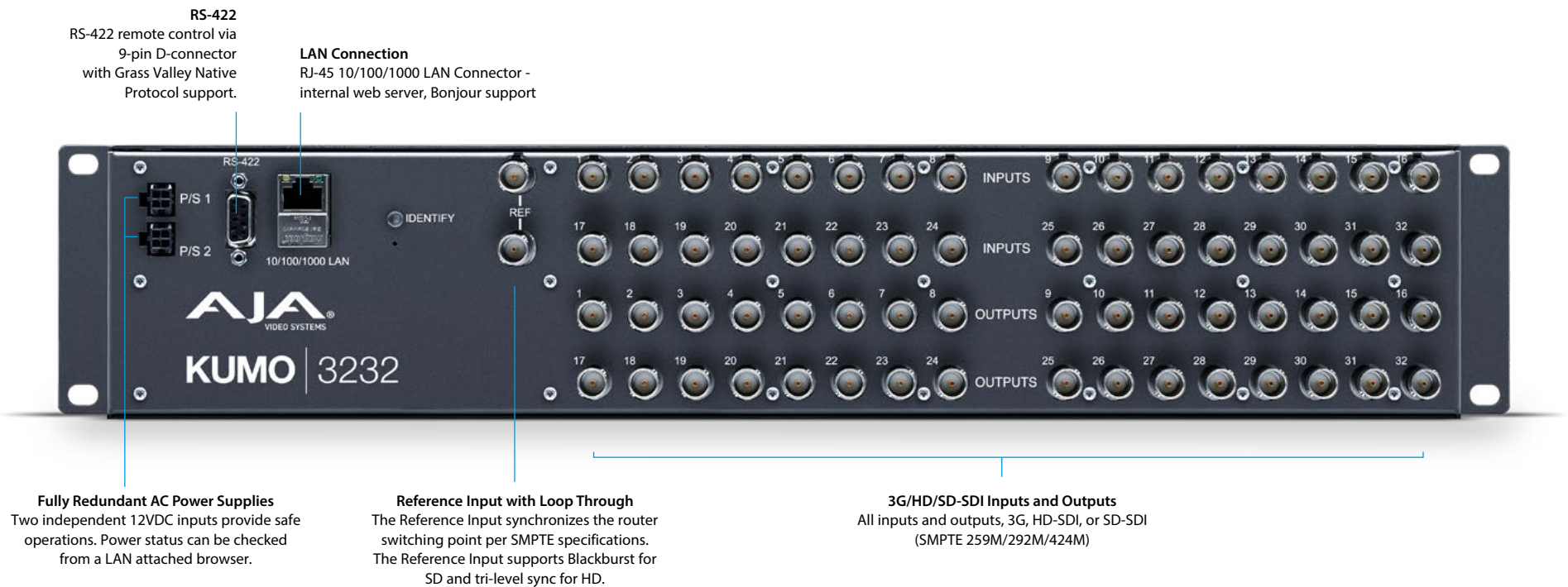

[Click here](#)

For full product specifications visit www.aja.com/en/products/kumo-3232/#techspecs

6464 Connections

KUMO 6464



[Click here](#)

For full product specifications visit www.aja.com/en/products/kumo-6464/#techspecs

Configurations

Stand-Alone Routing System - Zero Configuration, Just Plug, Power, and Play

KUMO Software assigns control to CPs based on KUMO router serial number order.

KUMO CPs



Each KUMO CP controls up to four KUMO Routers

KUMO Routers



Connect up to 16 Independent KUMO CP per individual KUMO Router

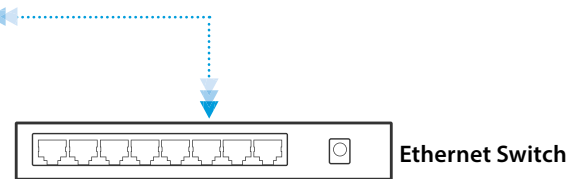

Configurations

LAN Only System - Use TCP/IP to Configure Routers and Devices



Control Unlimited KUMO Routers via TCP/IP

1. Use Bonjour to configure KUMO's TCP/IP settings
2. Control KUMOs from a web browser

Configurations

Hybrid System - KUMO's Controlled by KUMO CPs and Web Browsers

KUMO CPs

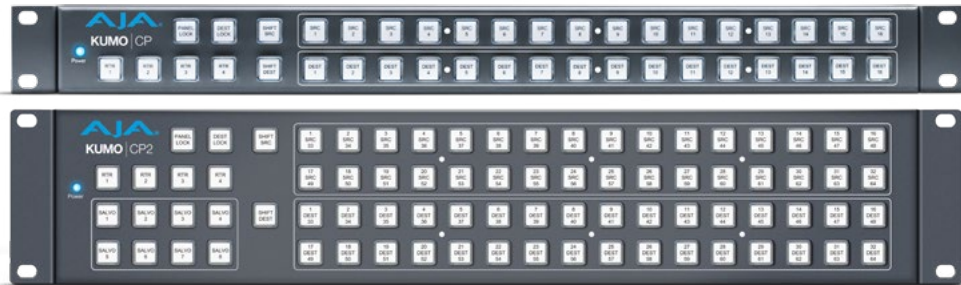

Each KUMO CP can control up to four KUMO routers at a time

KUMO Routers



Each KUMO router can be controlled by multiple CP panels

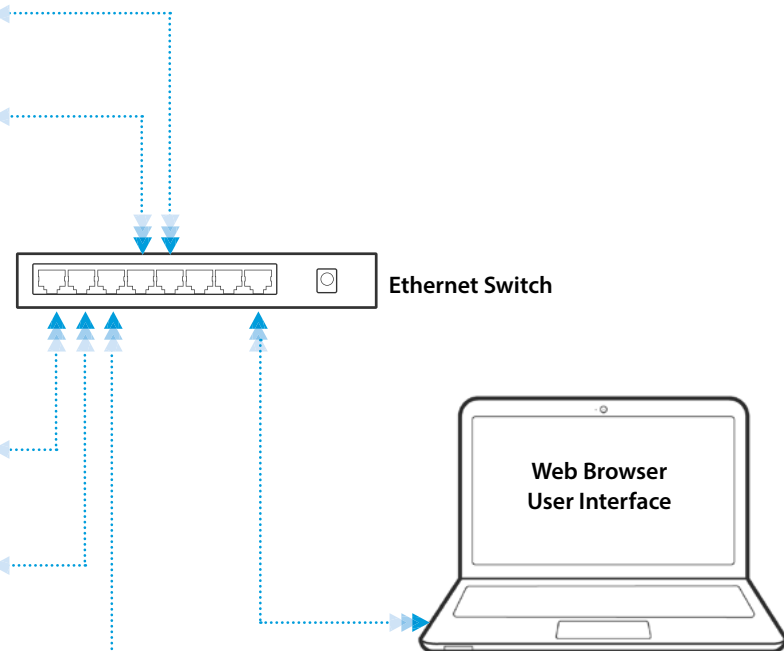

Control Unlimited KUMO Routers via TCP/IP

1. Use Bonjour to configure KUMO's TCP/IP settings
2. Control KUMOs from a web browser

Tech Specs

Video Formats

- (HD) 1080i 25, 29.97, 30
- (HD) 1080PsF 23.98, 24, 25, 29.97, 30
- (HD) 1080p 23.98, 24, 25, 29.97, 30, 50, 59.94, 60
- (HD) 720p 50, 59.94, 60
- (SD) 625i 25
- (SD) 525i 29.97

Video Input Digital

- 3G-SDI, SMPTE-259/292/424, 8 or 10-bits
- Single Link 4:2:2 (1 x BNC per input)

Video Output Digital

- 3G-SDI, SMPTE-259/292/424 8 or 10-bits
- Single Link 4:2:2 (1 x BNC per input)
- Reclocker: SMPTE 259/292/424 compliant, automatic rate selection

Audio Input Digital

- 8-Channel, 24-bit SMPTE-259 SDI embedded audio, 48 kHz sample rate, synchronous

Audio Output Digital

- 8-Channel, 24-bit SMPTE-259 SDI embedded audio, 48 kHz sample rate, synchronous

Timecode

- SDI RP188 preserved from inputs to outputs

Reference Input

- Analog Color Black (1V) or Composite Sync (2 or 4V)
- Looping, nonterminating

Salvo

- Eight Salvos can be configured and saved in each KUMO router
- Salvos can be recalled via the KUMO router's Web UI, Grass Valley Native Protocol over Ethernet or RS-232, and/or eight dedicated KUMO CP2 buttons.
NOTE: Salvo options for all KUMO Routers and KUMO CP2 models only. Not available on the KUMO CP.

Network Interface

- 10/100/1000 Ethernet (RJ-45)
- Embedded web server for remote control

Machine Control

- RS-422, Grass Valley Native Protocol
- 9-pin D-connector pinout is as follows:

1	GND
2	TX-
3	RX+
4	GND
5	No Connection
6	GND
7	TX+
8	RX-
9	GND
Shell	GND

Size (w x d x h)

- **KUMO CP:** 1RU - 17.4" x 1.3" x 1.75" (482.6mm x 39.1mm x 44.5mm)
- **KUMO CP2:** 2RU - 17.4" x 1.3" x 3.5" (482.6mm x 33.0mm x 89.0mm)
- **KUMO 1604:** 1RU - 17.4" x 1.5" x 1.75" (441.9mm x 38.1mm x 44.5mm)
- **KUMO 1616:** 1RU - 17.4" x 1.5" x 1.75" (482.6mm x 38.1mm x 44.5mm)
- **KUMO 3232:** 2RU - 17.4" x 1.5" x 3.5" (482.6mm x 38.1mm x 89.0mm)
- **KUMO 6464:** 4RU - 17.4" x 1.55" x 7" (482.6mm x 39.4mm x 177.8mm)

Weight

- **KUMO CP:** 1.2 lb (0.6 kg)
- **KUMO CP2:** 2.1 lb (1.0 kg)
- **KUMO 1604:** 1.2 lb (0.6 kg)
- **KUMO 1616:** 1.4 lb (0.7 kg)
- **KUMO 3232:** 4.6 lb (2.1 kg)
- **KUMO 6464:** 9.2 lbs (4.2 kg)

Power

100-240 VAC 50/60 Hz, 9-17 VDC, 12 VDC nominal,

Optional redundant power supply

- **KUMO CP:** 2.5W typical, 6W max
- **KUMO CP2:** 4W typical, 9.6W max
- **KUMO 1604:** 7W typical, 9.6W max
- **KUMO 1616:** 13W typical, 21.6W max
- **KUMO 3232:** 18W typical, 43.2W max
- **KUMO 6464:** 32W typical, 36W max

Environment

- Safe Operating Temperature: 0 to 40 degrees C (32 to 104 degrees F)
- Safe Storage Temperature (Power OFF): -40 to 60 degrees C (-40 to 140 degrees F)
- Operating Relative Humidity: 10-90% noncondensing
- Operating Altitude: <3,000 meters (<10,000 feet)

[Click here](#)

For full product specifications visit www.aja.com/en/products/kumo/#techspecs

Five Year Warranty

AJA Video warrants that KUMO routers will be free from defects in materials and workmanship for a period of five years from the date of purchase.

About AJA Video Systems, Inc.

Since 1993, AJA Video has been a leading manufacturer of video interface and conversion solutions, bringing high quality, cost effective digital video products to the professional, broadcast and postproduction markets.

AJA products are designed and manufactured at our facilities in Grass Valley, California, and sold through an extensive sales channel of resellers and systems integrators around the world. For further information, please see our website at www.aja.com